

Grandstream Networks, Inc.

**GRP261x/GRP262x/GRP263x/GRP2670/
GRP2650 Series - Administration Guide**



Thank you for purchasing Grandstream GRP26XX Carrier-Grade IP Phones.

The GRP26xx Professional Carrier-Grade IP Phones offer top-notch HD audio quality as well as a variety of telephony features. This series was designed for mass deployment and broad interoperability with most 3rd party SIP devices and platforms. With its sleek design, re-conceptualized user experience, the GRP26xx series comes with powerful out-of-the-box feature options including Bluetooth & Wi-Fi support, a dual LCD screen, support for up to 14 lines, 5-way conferencing for all models, and customizable face-plates for a touch of personalization. In addition to all the mentioned characteristics, the series is compatible with Grandstream’s cloud provisioning platform, GDMS (Grandstream Device Management System) for remote and cloud provisioning purposes. The GRP26xx is the perfect choice for enterprises looking for IP phones with advanced functionalities that are also easy to use and deploy.

PRODUCT OVERVIEW

Feature Highlights

The following table contains the major features of the GRP26XX phones:

 <p>GRP2610 GRP2610P</p>	<ul style="list-style-type: none"> ● 2 dual-color line keys (can be digitally programmed as up to 8 provisionable BLF/fast-dial keys) ● 2.4" (320×240) TFT color LCD. ● 4 programmable context-sensitive soft keys. ● 100M network ports. ● Integrated PoE (GRP2610P only). ● 5-way conference. ● Electronic Hook Switch (EHS).
 <p>GRP2611G</p>	<ul style="list-style-type: none"> ● 3 dual-color line keys (can be digitally programmed as up to 12 provisionable BLF/fast-dial keys) ● 2.8" (320×240) TFT color LCD. ● 4 programmable context-sensitive soft keys. ● 1000M network ports. ● Integrated PoE. ● 5-way conference. ● Electronic Hook Switch (EHS).
 <p>GRP2612 GRP2612P GRP2612W</p>	<ul style="list-style-type: none"> ● 4 dual-color line keys (can be digitally programmed as up to 16 provisionable BLF/fast-dial keys) ● 2.4" (320×240) TFT color LCD. ● 4 programmable context-sensitive soft keys. ● 100M network ports. (1000M for GRP2612G) ● Integrated PoE (GRP2612P, GRP2612G & GRP2612W only). ● 5-way conference. ● Electronic Hook Switch (EHS). ● Wi-Fi support (GRP2612W only).

GRP2612G



GRP2613

- 6 dual-color line keys (can be digitally programmed as up to 24 provisionable BLF/fast-dial keys).
- 2.8" (320×240) TFT color LCD.
- 4 programmable context-sensitive soft keys.
- 1000M network ports.
- 5-way conference.
- integrated PoE.
- Electronic Hook Switch (EHS).



GRP2614

- 4 dual-color line keys (can be digitally programmed as up to 16 provisionable BLF/fast-dial keys).
- 2.8" (320×240) TFT color LCD.
- 4 programmable context-sensitive soft keys
- 2.4" (320×240) additional screen dedicated to up to 24 multi-purpose keys.
- 1000M network ports.
- Integrated PoE.
- Wi-Fi and Bluetooth support.
- 5-way conference.
- Electronic Hook Switch (EHS).



GRP2615

- 10 dual-color line keys (can be digitally programmed as up to 40 provisionable BLF/fast-dial keys).
- 4.3" (480×272) TFT color LCD.
- 5 programmable context-sensitive soft keys.
- 1000M network ports.
- Integrated PoE.
- Wi-Fi and Bluetooth support.
- 5-way conference.
- Electronic Hook Switch (EHS).



GRP2616

- 6 dual-color line keys (can be digitally programmed as up to 24 provisionable BLF/fast-dial keys).
- 4.3" (480×272) TFT color LCD.
- 5 programmable context-sensitive soft keys.
- 2.4" (320×240) additional screen dedicated to up to 24 multi-purpose keys.
- 1000M network ports.
- Integrated PoE.
- Wi-Fi and Bluetooth support.
- 5-way conference.
- Electronic Hook Switch (EHS).



GRP2624

- 8 dual-color line keys (can be digitally programmed as up to 32 provisionable BLF/fast-dial keys).
- 2.8 inch (320×240) TFT color LCD.
- 4 programmable context-sensitive soft keys.
- 1000M network ports.
- Integrated PoE.
- Wi-Fi and Bluetooth support.
- 5-way conference.
- Electronic Hook Switch (EHS).



GRP2634

- 8 dual-color line keys (can be digitally programmed as up to 24 provisional BLF/fast-dial keys).
- 2.8 inch (320×240) TFT color LCD.
- 4 programmable context-sensitive soft keys.
- 2.4" (320×240) additional screen dedicated to up to 24 multi-purpose keys.
- 1000M network ports.
- Integrated PoE.
- Wi-Fi and Bluetooth support.
- 5-way conference.



GRP2636

- 12 lines with up to 16 SIP Accounts
- 24 dual-color line keys (can be digitally programmed as up to 24 provisional BLF/fast-dial keys).
- 4.3inch(480x272) TFT color LCD.
- 5 programmable context-sensitive soft keys.
- 1000M network ports.
- Wi-Fi and Bluetooth support.
- 5-way conference.



GRP2670

- 12 lines with up to 16 SIP Accounts
- 7" (1042x600) capacitive touch TFT color LCD.
- 1000M network ports.
- Integrated PoE.
- Wi-Fi and Bluetooth support.
- 5-way conference.



- 14 line keys with up to 16 SIP accounts (With 56 Virtual Multi-Purpose Keys (VPK))
- 5.0 inch (1280x720) TFT color LCD
- 6 XML programmable context sensitive softkeys
- Dual switched auto-sensing 10/100/1000 Mbps
- Integrated PoE
- Wi-Fi and Bluetooth support
- 5-way conference.

Technical Specifications

The following table resumes all the technical specifications including the protocols/standards supported, voice codecs, telephony features, languages, and upgrade/provisioning settings for the GRP261x/GRP2624/GRP263x/GRP2650/GRP2670 series.

Protocols/Standards	SIP RFC3261, TCP/IP/UDP, RTP/RTCP, HTTP/HTTPS, ARP, ICMP, DNS(A record, SRV,NAPTR), DHCP, PPPoE, TELNET, TFTP, NTP, STUN, SIMPLE, LLDP, LDAP, TR-069,802.1x, TLS, SRTP, IPV6
Network Interfaces	<ul style="list-style-type: none"> • Dual switched auto-sensing 10/100 Mbps Ethernet ports (GRP2610). • Dual switched auto-sensing 10/100 Mbps Ethernet ports with integrated PoE (GRP2610P).
Graphic Display	2.4 inch (320×240) TFT color LCD.
Feature Keys	2 line keys with up to 2 SIP accounts, 4 programmable contexts sensitive Softkeys, navigation/menu keys, 8 dedicated function keys for: MESSAGE(with LED indicator), TRANSFER, HEADSET, MUTE, SEND/REDIAL, SPEAKERPHONE, VOL+, VOL-
Voice Codec	Support for G7.29A/B, G.711μ/a-law, G.726, G.722(wide-band), G723, iLBC, OPUS, in-band and out-of-band DTMF(in audio, RFC2833, SIP INFO), VAD, CNG, AEC, PLC, AJB, AGC.
Auxiliary Ports	RJ9 headset jack (allowing EHS with Plantronics headsets).
Telephony Features	Hold, transfer, forward, 5-way conference, call park, call pickup, shared-call-appearance (SCA)/bridged-line-appearance (BLA), downloadable phonebook (XML, LDAP, up to 1000 items), call waiting, call log (up to 1000 records), XML customization of screen, off-hook auto dial, auto answer, click-to-dial, flexible dial plan, hot-desking, personalized music ringtones and music on hold, server redundancy and fail-over.
HD audio	Yes, HD handset and speakerphone with support for wideband audio.
Base Stand	Yes, allow 2 angle positions.
Wall Mountable	Yes, (*wall mount sold separately).
QoS	Layer 2 QoS (802.1Q, 802.1P), and Layer 3 (ToS, DiffServ, MPLS) QoS.
Security	User and administrator level passwords, MD5 and MD5-sess based authentication, 256-bit AES encrypted configuration file, SRTP, TLS, 802.1x media access control, secure boot.
Multi-language	<p>LCD Language: English 简体中文 (Simplified Chinese) العربية (Arabic) Català (Catalan) Čeština (Czech) Deutsch (German) Ελληνικά (Greek) Español (Spanish) Français (French) עברית (Hebrew) Hrvatski (Croatian) Magyar (Hungarian) Italiano (Italian) 日本語 (Japanese) 한국어 (Korean) Latviešu valoda (Latvian) Nederlands (Dutch) Polski (Polish) Português (Portuguese) Русский (Russian) Svenska (Swedish) Slovenščina (Slovenian) Slovenčina (Slovak) Türkçe (Turkish) Українська (Ukrainian) 正體中文 (Traditional Chinese)</p> <p>WebUI Language: English 简体中文 (Simplified Chinese) العربية (Arabic) Čeština (Czech) Deutsch (German) Español (Spanish) Français (French) עברית (Hebrew) Hrvatski (Croatian) Magyar (Hungarian) Italiano (Italian) 日本語 (Japanese) 한국어 (Korean) Nederlands (Dutch) Polski (Polish) Português (Portuguese) Русский (Russian) Slovenščina (Slovenian) Türkçe (Turkish) 繁體中文 (Traditional Chinese)</p>

Upgrade/Provisioning	Firmware upgrade via FTP/TFTP/TFTPS/HTTP/HTTPS, mass provisioning using GDMS/TR-069 or AES encrypted XML configuration file.
Power & Green Energy Efficiency	Universal power adapter included: Input: 100-240V ; Output: +5V, 0.6A ; Integrated Power-over-Ethernet (802.3af); IEEE 802.3az Energy-Efficient Ethernet; Max power consumption 3W (power adapter, GRP2610) or 3.8W (PoE, GRP2610P).
Physical	Dimension : 203mm x 186mm x 28mm. Unit weight : 0.4kg. Package weight : 0.9kg.
Temperature and Humidity	Operation: 0°C to 40°C. Storage: -10°C to 60°C. Humidity: 10% to 90% Non-condensing.
Package Content	GRP2610 phone, handset with cord, phone stand, 5V power adapter (with GRP2610 only), network cable, Quick Installation Guide.
Compliance	FCC: Part 15 Class B; FCC Part 68 HAC. CE: EN 55032; EN 55035; EN IEC 61000-3-2; EN 61000-3-3; EN IEC 62368-1. RCM: AS/ NZS CISPR 32; AS/NZS 62368.1; AS/CA S004/S040. IC: ICES-003; CS-03, Part V.

GRP2610/GRP2610P Technical Specifications

Protocols/Standards	SIP RFC3261, TCP/IP/UDP, RTP/RTCP, HTTP/HTTPS, ARP, ICMP, DNS(A record, SRV,NAPTR), DHCP, PPPoE, TELNET, TFTP, NTP, STUN, SIMPLE, LLDP, LDAP, TR-069, 802.1x, TLS, SRTP, IPV6
Network Interfaces	Dual switched auto-sensing 10/100/1000 Mbps Gigabit Ethernet ports with integrated PoE.
Graphic Display	2.4 inch (320×240) TFT color LCD.
Feature Keys	3 line keys with up to 3 SIP accounts, 4 programmable contexts sensitive Softkeys, 5 navigation/menu keys, 8 dedicated function keys for: MESSAGE(with LED indicator), TRANSFER, HEADSET, MUTE, SEND/REDIAL, SPEAKERPHONE, VOL+, VOL-
Voice Codec	Support for G7.29A/B, G.711μ/a-law, G.726, G.722(wide-band), G723, iLBC, OPUS, in-band and out-of-band DTMF(in audio, RFC2833, SIP INFO), VAD, CNG, AEC, PLC, AJB, AGC.
Auxiliary Ports	RJ9 headset jack (allowing EHS with Plantronics headsets).
Telephony Features	Hold, transfer, forward, 5-way conference, call park, call pickup, shared-call-appearance (SCA)/bridged-line-appearance (BLA), downloadable phonebook (XML, LDAP, up to 1000 items), call waiting, call log (up to 1000 records), XML customization of screen, off-hook auto dial, auto answer, click-to-dial, flexible dial plan, hot-desking, personalized music ringtones and music on hold, server redundancy and fail-over.
HD audio	Yes, HD handset and speakerphone with support for wideband audio.
Base Stand	Yes, allow 2 angle positions.
Wall Mountable	Yes, (*wall mount sold separately).
QoS	Layer 2 QoS (802.1Q, 802.1P) and Layer 3 (ToS, DiffServ, MPLS) QoS.

Security	User and administrator level passwords, MD5 and MD5-sess based authentication, 256-bit AES encrypted configuration file, SRTP, TLS, 802.1x media access control, secure boot.
Multi-language	<p>LCD Language: English 简体中文 (Simplified Chinese) العربية (Arabic) Català (Catalan) Čeština (Czech) Deutsch (German) Ελληνικά (Greek) Español (Spanish) Français (French) עברית (Hebrew) Hrvatski (Croatian) Magyar (Hungarian) Italiano (Italian) 日本語 (Japanese) 한국어 (Korean) Latviešu valoda (Latvian) Nederlands (Dutch) Polski (Polish) Português (Portuguese) Русский (Russian) Svenska (Swedish) Slovenščina (Slovenian) Slovenčina (Slovak) Türkçe (Turkish) Українська (Ukrainian) 正體中文 (Traditional Chinese)</p> <p>WebUI Language: English 简体中文 (Simplified Chinese) العربية (Arabic) Čeština (Czech) Deutsch (German) Español (Spanish) Français (French) עברית (Hebrew) Hrvatski (Croatian) Magyar (Hungarian) Italiano (Italian) 日本語 (Japanese) 한국어 (Korean) Nederlands (Dutch) Polski (Polish) Português (Portuguese) Русский (Russian) Slovenščina (Slovenian) Türkçe (Turkish) 繁體中文 (Traditional Chinese)</p>
Upgrade/Provisioning	Firmware upgrade via FTP/TFTP/TFTPS/HTTP/HTTPS, mass provisioning using GDMS/TR-069 or AES encrypted XML configuration file.
Power & Green Energy Efficiency	<p>Universal power adapter included: Input: 100-240V ; Output: +5V, 0.6A ; Integrated Power-over-Ethernet (802.3af); IEEE 802.3az Energy-Efficient Ethernet; Max power consumption 3W (power adapter) or 3.8W (PoE).</p>
Physical	<p>Dimension : 203mm x 186mm x 28mm. Unit weight : 0.4kg. Package weight : 0.9kg.</p>
Temperature and Humidity	<p>Operation: 0°C to 40°C. Storage: -10°C to 60°C. Humidity: 10% to 90% Non-condensing.</p>
Package Content	GRP2611G phone, handset with cord, phone stand, 5V power adapter, network cable, Quick Installation Guide.
Compliance	<p>FCC: Part 15 Class B; FCC Part 68 HAC. CE: EN 55032; EN 55035; EN IEC 61000-3-2; EN 61000-3-3; EN IEC 62368-1. RCM: AS/NZS CISPR 32; AS/NZS 62368.1; AS/CA S004/S040. IC: ICES-003; CS-03, Part V.</p>

GRP2611G Technical Specifications

Protocols/Standards	SIP RFC3261, TCP/IP/UDP, RTP/RTCP/RTCP-XR, HTTP/HTTPS, ARP, ICMP, DNS (A record, SRV, NAPTR), DHCP, PPPoE, SSH, TFTP, FTP/FTPS, NTP, STUN, SIMPLE, LLDP, LDAP, TR-069, 802.1x, TLS, SRTP, IPv6
Network Interfaces	<p>Dual switched auto-sensing 10/100 Mbps Ethernet ports (GRP2612)</p> <p>Dual switched auto-sensing 10/100 Mbps Ethernet ports with integrated PoE (GRP2612P & GRP2612W)</p> <p>Dual switched auto-sensing 10/100/1000 Mbps Gigabit Ethernet ports with integrated PoE (GRP2612G)</p>
Graphic Display	2.4 inch (320×240) TFT color LCD
Feature Keys	4 line keys with up to 4 SIP accounts and up to 2 SIP accounts for legacy hardware (discontinued in 2020), 4 programmable contexts sensitive Softkeys, 5 navigation/menu keys, 9 dedicated function keys for: MESSAGE (with LED indicator), TRANSFER, HOLD, HEADSET, MUTE, SEND/REDIAL, SPEAKERPHONE, VOLUME+, VOLUME-

Voice Codec	Support for G.729A/B, G723.1, G.711μ/a-law, G.726, G.722 (wide-band), OPUS, iLBC and in-band and out-of-band DTMF (in audio, RFC2833, SIP INFO)
Auxiliary Ports	RJ9 headset jack (allowing EHS with Plantronics headsets)
Telephony Features	Hold, transfer, forward, 5-way conference, call park, call pickup, shared-call-appearance (SCA), bridged-line-appearance (BLA), downloadable phonebook (XML, LDAP, up to 1000 items), call waiting, call log (up to 2000 records), customization of screen, off-hook auto dial, auto answer, click-to-dial, flexible dial plan, hot desking, personalized music ringtones and music on hold, server redundancy and fail-over
HD audio	Yes, both on handset and full-duplex handsfree speakerphone
Base Stand	Yes, allow 2 angle positions
Wall Mountable	Yes, (*wall mount sold separately)
QoS	Layer 2 (802.1Q, 802.1p) and Layer 3 (ToS, DiffServ, MPLS) QoS
Security	User and administrator level passwords, MD5 and MD5-sess based authentication, AES based secure configuration file, SRTP, TLS, 802.1x media access control
Multi-language	LCD Language: English 简体中文 (Simplified Chinese) العربية (Arabic) Català (Catalan) Čeština (Czech) Deutsch (German) Ελληνικά (Greek) Español (Spanish) Français (French) עברית (Hebrew) Hrvatski (Croatian) Magyar (Hungarian) Italiano (Italian) 日本語 (Japanese) 한국어 (Korean) Latviešu valoda (Latvian) Nederlands (Dutch) Polski (Polish) Português (Portuguese) Русский (Russian) Svenska (Swedish) Slovenščina (Slovenian) Slovenčina (Slovak) Türkçe (Turkish) Українська (Ukrainian) 正體中文 (Traditional Chinese) WebUI Language: English 简体中文 (Simplified Chinese) العربية (Arabic) Čeština (Czech) Deutsch (German) Español (Spanish) Français (French) עברית (Hebrew) Hrvatski (Croatian) Magyar (Hungarian) Italiano (Italian) 日本語 (Japanese) 한국어 (Korean) Nederlands (Dutch) Polski (Polish) Português (Portuguese) Русский (Russian) Slovenščina (Slovenian) Türkçe (Turkish) 繁體中文 (Traditional Chinese)
Upgrade/Provisioning	Firmware upgrade via TFTP/FTP/FTPS/HTTP/HTTPS, mass provisioning using TR-069 or encrypted XML configuration file
Power & Green Energy Efficiency	Universal power adapter included: Input:100-240 VAC; Output: +5VDC, 0.5A; Integrated Power-over-Ethernet (802.3af)
Physical	Dimension : 203mm x 193mm x 52.1mm Unit weight : 554g Package weight : 936g
Temperature and Humidity	32-104°F / 0 ~ 40°C, 10-90% (non- condensing)
Package Content	GRP2612/GRP2612P/GRP2612W/GRP2612G phone, handset with cord, base stand, universal power supply (except GRP2612P), network cable, Quick Installation Guide
Compliance	GRP2612/GRP2612P/GRP2612G: FCC: Part 15 Class B; FCC Part 68 HAC. CE: EN 55032; EN 55035; EN 61000-3-2; EN 61000-3-3; EN IEC 62368-1. RCM: AS/NZS CISPR 32; AS/NZS 62368.1; AS/CA S004 IC: ICES-003; CS-03, Part V. GRP2612W: FCC: Part 15 Class B; Part 15 Subpart C, 15.247; Part 15 Subpart E, 15.407; FCC Part 68 HAC. CE: EN 55032; EN 55035; EN IEC 61000-3-2; EN 61000-3-3; EN IEC 62368-1; EN 301 489-1; EN 301 489-17; EN 300 328; EN 301 893; EN 62311.

RCM: AS/NZS CISPR 32; AS/NZS 62368.1; AS/NZS 4268; AS/NZS 2772.2; AS/CA S004.
 IC: ICES-003; CS-03, Part V; RSS-247; RSS-102.

GRP2612/GRP2612P/GRP2612W Technical Specifications

Protocols/Standards	SIP RFC3261, TCP/IP/UDP, RTP/RTCP, HTTP/HTTPS, ARP, ICMP, DNS(A record, SRV, NAPTR), DHCP, PPPoE, TELNET, TFTP, NTP, STUN, SIMPLE, LLDP, LDAP, TR-069, 802.1x, TLS, SRTP, IPV6
Network Interfaces	Dual switched auto-sensing 10/100/1000 Mbps Ethernet ports with integrated PoE
Graphic Display	2.8 inch (320x240) TFT color LCD – 2.4 inch MPK color LCD
Feature Keys	6 line keys with up to 4 SIP accounts, up to 3 SIP accounts for legacy hardware (discontinued in 2020), 5 navigation/menu keys, 11 dedicated function keys for: MESSAGE(with LED indicator), PHONEBOOK, TRANSFER, CONFERENCE, HOLD, HEADSET, MUTE, SEND/REDIAL, SPEAKERPHONE, VOL+, VOL-
Voice Codec	Support for G7.29A/B, G.711 μ /a-law, G.726, G.722(wide-band), G723, iLBC, OPUS, in-band and out-of-band DTMF(in audio, RFC2833, SIP INFO), VAD, CNG, AEC, PLC, AJB, AGC
Auxiliary Ports	RJ9 headset jack (allowing EHS with Plantronics headsets)
Telephony Features	Hold, transfer, forward, 5-way conference, call park, call pickup, shared-call-appearance(SCA)/bridged-line-appearance(BLA), downloadable phonebook(XML, LDAP, up to 1000 items), call waiting, call log (up to 2000 records), XML customization of screen, off-hook auto dial, auto answer, click-to-dial, flexible dial plan, hot-desking, personalized music ringtones and music on hold, server redundancy and fail-over
HD audio	Yes, HD handset and speakerphone with support for wideband audio
Base Stand	Yes, allow 2 angle positions
Wall Mountable	Yes, (*wall mount sold separately)
QoS	Layer 2 (802.1q, 802.1p) and Layer 3 (ToS, DiffServ, MPLS) QoS
Security	User and administrator level passwords, MD5 and MD5-sess based authentication, 256-bit AES encrypted configuration file, SRTP, TLS, 802.1x media access control, secure boot
Multi-language	LCD Language: English 简体中文 (Simplified Chinese) العربية (Arabic) Català (Catalan) Čeština (Czech) Deutsch (German) Ελληνικά (Greek) Español (Spanish) Français (French) עברית (Hebrew) Hrvatski (Croatian) Magyar (Hungarian) Italiano (Italian) 日本語 (Japanese) 한국어 (Korean) Latviešu valoda (Latvian) Nederlands (Dutch) Polski (Polish) Português (Portuguese) Русский (Russian) Svenska (Swedish) Slovenščina (Slovenian) Slovenčina (Slovak) Türkçe (Turkish) Українська (Ukrainian) 正體中文 (Traditional Chinese) WebUI Language: English 简体中文 (Simplified Chinese) العربية (Arabic) Čeština (Czech) Deutsch (German) Español (Spanish) Français (French) עברית (Hebrew) Hrvatski (Croatian) Magyar (Hungarian) Italiano (Italian) 日本語 (Japanese) 한국어 (Korean) Nederlands (Dutch) Polski (Polish) Português (Portuguese) Русский (Russian) Slovenščina (Slovenian) Türkçe (Turkish) 繁體中文 (Traditional Chinese)
Upgrade/Provisioning	Firmware upgrade via FTP/TFTP/TFTPS/HTTP/HTTPS, mass provisioning using GDMS/TR-069 or AES encrypted XML configuration file
Power & Green Energy Efficiency	Universal power adapter included: Input:100-240V ; Output: +5V, 0.6A ; Integrated Power-over-Ethernet(802.3af)

	IEEE 802.3az Energy-Efficient Ethernet Max power consumption 3W(power adapter) or 3.8W(PoE)
Physical	Dimension : 203mm x 193mm x 52.1mm Unit weight : 554g Package weight : 936g
Temperature and Humidity	Operation: 0°C to 40°C Storage: -10°C to 60°C Humidity: 10% to 90% Non-condensing
Package Content	GRP2613(W) phone, handset with cord, base stand, universal power supply, network cable, Quick Installation Guide
Compliance	FCC: Part 15 Class B; FCC Part 68 HAC CE: EN 55032; EN 55035; EN 61000-3-2; EN 61000-3-3; EN 62368-1 RCM: AS/NZS CISPR32;AS/NZS 61000.3.2; AS/NZS 61000.3.3;AS/NZS 62368.1; AS/CA S004 IC: ICES-003; CS-03

GRP2613 Technical Specifications

Protocols/Standards	SIP RFC3261, TCP/IP/UDP, RTP/RTCP/RTCP-XR, HTTP/HTTPS, ARP, ICMP, DNS (A record, SRV, NAPTR), DHCP, PPPoE, SSH, TFTP, FTP/FTPS, NTP, STUN, SIMPLE, LLDP, LDAP, TR-069, 802.1x, TLS, SRTP, IPv6
Network Interfaces	Dual switched auto-sensing 10/100/1000 Mbps Ethernet ports with integrated PoE
Graphic Display	2.8 inch (320×240) TFT color LCD – 2.4 inch MPK color LCD
Bluetooth	Yes, Bluetooth integrated
Wi-Fi	Yes, dual-band
Feature Keys	4 line keys with up to 12 SIP accounts, 24 speed-dial/BLF extension keys with dual-color LED, 4 programmable contexts sensitive Softkeys, 5 navigation/menu keys, 11 dedicated function keys for: MESSAGE (with LED indicator), PHONEBOOK, TRANSFER, CONFERENCE, HOLD, HEADSET, MUTE, SEND/REDIAL, SPEAKERPHONE, VOLUME+, VOLUME-
Voice Codec	Support for G.729A/B, G.711μ/a-law, G.726, G.722 (wide-band), OPUS, iLBC and in-band and out-of-band DTMF (in audio, RFC2833, SIP INFO)
Auxiliary Ports	RJ9 headset jack (allowing EHS with Plantronics headsets).
Telephony Features	Hold, transfer, forward, 5-way conference, call park, call pickup, shared-call-appearance (SCA)/bridged-line-appearance (BLA), downloadable phonebook (XML, LDAP, up to 2000 items), call waiting, call log (up to 2000 records), customization of screen, off-hook auto dial, auto answer, click-to-dial, flexible dial plan, Hot Desking, personalized music ringtones and music on hold, server redundancy and fail-over
HD audio	Yes, both on handset and full-duplex handsfree speakerphone
Base Stand	Yes, allow 2 angle positions
Wall Mountable	Yes, (*wall mount sold separately)
QoS	Layer 2 (802.1Q, 802.1p) and Layer 3 (ToS, DiffServ, MPLS) QoS

Security	User and administrator level passwords, MD5 & MD5-sess based authentication, AES based secure configuration file, SRTP, TLS, 802.1x media access control
Multi-language	<p>LCD Language: English 简体中文 (Simplified Chinese) العربية (Arabic) Català (Catalan) Čeština (Czech) Deutsch (German) Ελληνικά (Greek) Español (Spanish) Français (French) עברית (Hebrew) Hrvatski (Croatian) Magyar (Hungarian) Italiano (Italian) 日本語 (Japanese) 한국어 (Korean) Latviešu valoda (Latvian) Nederlands (Dutch) Polski (Polish) Português (Portuguese) Русский (Russian) Svenska (Swedish) Slovenščina (Slovenian) Slovenčina (Slovak) Türkçe (Turkish) Українська (Ukrainian) 正體中文 (Traditional Chinese)</p> <p>WebUI Language: English 简体中文 (Simplified Chinese) العربية (Arabic) Čeština (Czech) Deutsch (German) Español (Spanish) Français (French) עברית (Hebrew) Hrvatski (Croatian) Magyar (Hungarian) Italiano (Italian) 日本語 (Japanese) 한국어 (Korean) Nederlands (Dutch) Polski (Polish) Português (Portuguese) Русский (Russian) Slovenščina (Slovenian) Türkçe (Turkish) 繁體中文 (Traditional Chinese)</p>
Upgrade/Provisioning	Firmware upgrade via TFTP/FTP/FTPS/HTTP/HTTPS, mass provisioning using TR-069 or encrypted XML configuration file
Power & Green Energy Efficiency	<p>Universal power adapter included: Input:100-240V; Output: +12V, 0.5A;</p> <p>Integrated Power-over-Ethernet (802.3af)</p> <p>Max power consumption: 6W</p>
Physical	<p>Dimension : 234mm x 213mm x 82.2mm</p> <p>Unit weight : 950g</p> <p>Package weight : 1460g</p>
Temperature and Humidity	32-104°F / 0 ~ 40°C, 10-90% (non- condensing)
Package Content	GRP2614 phone, handset with cord, base stand, universal power supply, network cable, Quick Installation Guide
Compliance	<p>FCC: FCC Part 15B, Class B; FCC Part 15 Subpart C; FCC Part 15 Subpart E; FCC Part 68 HAC.</p> <p>CE: EN 55032; EN 55035; EN 61000-3-2; EN 61000-3-3; EN 62368-1; EN 301 489-1/-17; EN 300 328; EN 301 893; EN 62311;</p> <p>RCM: AS/NZS CISPR 32; AS/NZS 60950.1; AS/NZS 4268; AS/CA S004.</p>

GRP2614 Technical Specifications

Protocols/Standards	SIP RFC3261, TCP/IP/UDP, RTP/RTCP/RTCP-XR, HTTP/HTTPS, ARP, ICMP, DNS (A record, SRV, NAPTR), DHCP, PPPoE, SSH, TFTP, FTP/FTPS, NTP, STUN, SIMPLE, LLDP, LDAP, TR-069, 802.1x, TLS, SRTP, IPv6
Network Interfaces	Dual switched auto-sensing 10/100/1000 Mbps Ethernet ports with integrated PoE
Graphic Display	4.3 inch (480×272) TFT color LCD – 2.4 inch MPK color LCD
Bluetooth	Yes, Bluetooth integrated
Wi-Fi	Yes, dual-band
Feature Keys	10 line keys with up to 16 SIP accounts, 40 speed-dial/BLF extension keys with dual-color LED, 5 programmable contexts sensitive Softkeys, 5 navigation/menu keys, 9 dedicated function keys for: MESSAGE (with LED indicator), TRANSFER, HOLD, HEADSET, MUTE, SEND/REDIAL, SPEAKERPHONE, VOLUME+, VOLUME-

Voice Codec	Support for G.729A/B, G.711μ/a-law, G.726, G.722 (wide-band), OPUS, iLBC and in-band and out-of-band DTMF (in audio, RFC2833, SIP INFO)
Auxiliary Ports	RJ9 headset jack (allowing EHS with Plantronics headsets), USB port.
Telephony Features	Hold, transfer, forward, 5-way conference, call park, call pickup, shared-call-appearance (SCA)/bridged-line-appearance (BLA), downloadable phonebook (XML, LDAP, up to 2000 items), call waiting, call log (up to 2000 records), customization of screen, off-hook auto dial, auto answer, click-to-dial, flexible dial plan, Hot Desking, personalized music ringtones and music on hold, server redundancy and fail-over
HD audio	Yes, both on handset and full-duplex handsfree speakerphone
Base Stand	Yes, allow 2 angle positions
Wall Mountable	Yes, (*wall mount sold separately)
QoS	Layer 2 (802.1Q, 802.1p) and Layer 3 (ToS, DiffServ, MPLS) QoS
Security	User and administrator level passwords, MD5 & MD5-sess based authentication, AES based secure configuration file, SRTP, TLS, 802.1x media access control
Multi-language	LCD Language: English 简体中文 (Simplified Chinese) العربية (Arabic) Català (Catalan) Čeština (Czech) Deutsch (German) Ελληνικά (Greek) Español (Spanish) Français (French) עברית (Hebrew) Hrvatski (Croatian) Magyar (Hungarian) Italiano (Italian) 日本語 (Japanese) 한국어 (Korean) Latviešu valoda (Latvian) Nederlands (Dutch) Polski (Polish) Português (Portuguese) Русский (Russian) Svenska (Swedish) Slovenščina (Slovenian) Slovenčina (Slovak) Türkçe (Turkish) Українська (Ukrainian) 正體中文 (Traditional Chinese) WebUI Language: English 简体中文 (Simplified Chinese) العربية (Arabic) Čeština (Czech) Deutsch (German) Español (Spanish) Français (French) עברית (Hebrew) Hrvatski (Croatian) Magyar (Hungarian) Italiano (Italian) 日本語 (Japanese) 한국어 (Korean) Nederlands (Dutch) Polski (Polish) Português (Portuguese) Русский (Russian) Slovenščina (Slovenian) Türkçe (Turkish) 繁體中文 (Traditional Chinese)
Upgrade/Provisioning	Firmware upgrade via TFTP/FTP/FTPS/HTTP/HTTPS, mass provisioning using TR-069 or encrypted XML configuration file
Power & Green Energy Efficiency	Universal power adapter included: Input:100-240V; Output: +12V, 0.5A; Integrated Power-over-Ethernet (802.3af)
Physical	Dimensions : 243mm x 210mm x 82.3mm Unit weight:970g Package weight:1480g
Temperature and Humidity	32-104°F / 0 ~ 40°C, 10-90% (non- condensing)
Package Content	GRP2615 phone, handset with cord, base stand, universal power supply, network cable, Quick Installation Guide
Compliance	FCC: FCC Part 15B, Class B; FCC Part 15 Subpart C; FCC Part 15 Subpart E; FCC Part 68 HAC. CE: EN 55032; EN 55035; EN 61000-3-2; EN 61000-3-3; EN 62368-1; EN 301 489-1/-17; EN 300 328; EN 301 893; EN 62311; RCM: AS/NZS CISPR 32; AS/NZS 60950.1; AS/NZS 4268; AS/CA S004.

Protocols/Standards	SIP RFC3261, TCP/IP/UDP, RTP/RTCP/RTCP-XR, HTTP/HTTPS, ARP, ICMP, DNS (A record, SRV, NAPTR), DHCP, PPPoE, SSH, TFTP, FTP/FTPS, NTP, STUN, SIMPLE, LLDP, LDAP, TR-069, 802.1x, TLS, SRTP, IPv6
Network Interfaces	Dual switched auto-sensing 10/100/1000 Mbps Ethernet ports with integrated PoE
Graphic Display	4.3 inch (480×272) TFT color LCD – 2.4 inch MPK color LCD
Bluetooth	Yes, Bluetooth integrated
Wi-Fi	Yes, dual-band
Feature Keys	6 line keys with up to 16 SIP accounts, 24 speed-dial/BLF extension keys with dual-color LED, 5 programmable contexts sensitive Softkeys, 5 navigation/menu keys, 11 dedicated function keys for: MESSAGE (with LED indicator), PHONEBOOK, TRANSFER, CONFERENCE, HOLD, HEADSET, MUTE, SEND/REDIAL, SPEAKERPHONE, VOLUME+, VOLUME-
Voice Codec	Support for G.729A/B, G.711μ/a-law, G.726, G.722 (wide-band), OPUS, iLBC and in-band and out-of-band DTMF (in audio, RFC2833, SIP INFO)
Auxiliary Ports	RJ9 headset jack (allowing EHS with Plantronics headsets), USB port.
Telephony Features	Hold, transfer, forward, 5-way conference, call park, call pickup, shared-call-appearance (SCA)/bridged-line-appearance (BLA), downloadable phonebook (XML, LDAP, up to 2000 items), call waiting, call log (up to 2000 records), customization of screen, off-hook auto dial, auto answer, click-to-dial, flexible dial plan, Hot Desking, personalized music ringtones and music on hold, server redundancy and fail-over.
HD audio	Yes, both on handset and full-duplex handsfree speakerphone
Base Stand	Yes, allow 2 angle positions
Wall Mountable	Yes
QoS	Layer 2 (802.1Q, 802.1p) and Layer 3 (ToS, DiffServ, MPLS) QoS
Security	User and administrator level passwords, MD5 & MD5-ess based authentication, AES based secure configuration file, SRTP, TLS, 802.1x media access control
Multi-language	LCD Language: English 简体中文 (Simplified Chinese) العربية (Arabic) Català (Catalan) Čeština (Czech) Deutsch (German) Ελληνικά (Greek) Español (Spanish) Français (French) עברית (Hebrew) Hrvatski (Croatian) Magyar (Hungarian) Italiano (Italian) 日本語 (Japanese) 한국어 (Korean) Latviešu valoda (Latvian) Nederlands (Dutch) Polski (Polish) Português (Portuguese) Русский (Russian) Svenska (Swedish) Slovenščina (Slovenian) Slovenčina (Slovak) Türkçe (Turkish) Українська (Ukrainian) 正體中文 (Traditional Chinese) WebUI Language: English 简体中文 (Simplified Chinese) العربية (Arabic) Čeština (Czech) Deutsch (German) Español (Spanish) Français (French) עברית (Hebrew) Hrvatski (Croatian) Magyar (Hungarian) Italiano (Italian) 日本語 (Japanese) 한국어 (Korean) Nederlands (Dutch) Polski (Polish) Português (Portuguese) Русский (Russian) Slovenščina (Slovenian) Türkçe (Turkish) 繁體中文 (Traditional Chinese)
Upgrade/Provisioning	Firmware upgrade via TFTP/FTP/FTPS/HTTP/HTTPS, mass provisioning using TR-069 or encrypted XML configuration file
Power & Green Energy Efficiency	Universal power adapter included: Input:100-240V; Output: +12V, 0.5A; Integrated Power-over-Ethernet (802.3af)

Temperature and Humidity	32-104°F / 0 ~ 40°C, 10-90% (non- condensing)
Package Content	GRP2616 phone, handset with cord, base stand, universal power supply, network cable, Quick Installation Guide
Compliance	FCC: FCC Part 15B, Class B; FCC Part 15 Subpart C; FCC Part 15 Subpart E; FCC Part 68 HAC. CE: EN 55032; EN 55035; EN 61000-3-2; EN 61000-3-3; EN 62368-1; EN 301 489-1/-17; EN 300 328; EN 301 893; EN 62311; RCM: AS/NZS CISPR 32; AS/NZS 60950.1; AS/NZS 4268; AS/CA S004.

GRP2616 Technical Specifications

Protocols/Standards	SIP RFC3261, TCP/IP/UDP, RTP/RTCP/RTCP-XR, HTTP/HTTPS, ARP, ICMP, DNS (A record, SRV, NAPTR), DHCP, PPPoE, SSH, TFTP, FTP/FTPS, NTP, STUN, SIMPLE, LLDP, LDAP, TR-069, 802.1x, TLS, SRTP, IPv6
Network Interfaces	Dual switched auto-sensing 10/100/1000 Mbps Ethernet ports with integrated PoE
Graphic Display	2.8 inch (320×240) TFT color LCD
Bluetooth	Yes, Bluetooth integrated
Wi-Fi	Yes, dual-band
Feature Keys	8 line keys with up to 12 SIP accounts, 4 XML programmable context sensitive softkeys, 5 navigation/menu keys, 9 dedicated function keys for: MESSAGE(with LED indicator), TRANSFER, HOLD, HEADSET, MUTE, SEND/REDIAL, SPEAKERPHONE, VOL+, VOL-
Voice Codec	Support for G.729A/B, G.711μ/a-law, G.726, G.722 (wide-band), OPUS, iLBC and in-band and out-of-band DTMF (in audio, RFC2833, SIP INFO)
Auxiliary Ports	RJ9 headset jack allowing EHS with Plantronics headsets, USB to support Grandstream's GUV Series headsets and other USB headsets
Telephony Features	Hold, transfer, forward, 5-way conference, call park, call pickup, shared-callappearance(SCA)/bridged-line-appearance(BLA), downloadable phonebook(XML, LDAP, up to 2000 items), call waiting, call log(up to 2000 records), XML customization of screen, off-hook auto dial, auto answer, click-to-dial, flexible dial plan, hot-desking, personalized music ringtones and music on hold, server redundancy and fail-over
HD audio	Yes, HD handset and speakerphone with support for wideband audio, and dual microphone.
Base Stand	Yes, 2 angle positions available, Wall Mountable (Wall Mount *sold separately)
Wall Mountable	Yes
QoS	Layer 2 QoS (802.1Q, 802.1P) and Layer 3 (ToS, DiffServ, MPLS) QoS
Security	User and administrator level passwords, MD5 and MD5-sess based authentication, 256-bit AES encrypted configuration file, SRTP, TLS, 802.1x media access control, secure boot.
Multi-language	
Upgrade/Provisioning	Firmware upgrade via FTP/TFTP / HTTP / HTTPS, mass provisioning using GDMS/TR069 or AES encrypted XML configuration file.

Power & Green Energy Efficiency	Universal power adapter included: Input: 100-240V ; Output: +12V, 1A ; Integrated Power-over-Ethernet (802.3af) Max power consumption 9.5W (power adapter) or 10.8W (PoE)
Temperature and Humidity	Operation: 0°C to 40°C Storage: -10°C to 60°C Humidity: 10% to 90% Non-condensing
Package Content	GRP2624 phone, handset with cord, phone stand, 12V power adapter, network cable, Quick Installation Guide, GPL license
Compliance	FCC: FCC Part 15B, Class B; FCC Part 15 Subpart C; FCC Part 15 Subpart E; FCC Part 68 HAC. CE: EN 55032; EN 55035; EN 61000-3-2; EN 61000-3-3; EN 62368-1; EN 301 489-1/-17; EN 300 328; EN 301 893; EN 62311; RCM: AS/NZS CISPR 32; AS/NZS 60950.1; AS/NZS 4268; AS/CA S004.

GRP2624 Technical Specifications

Protocols/Standards	SIP RFC3261, TCP/IP/UDP, RTP/RTCP, HTTP/HTTPS, ARP, ICMP, DNS(A record, SRV, NAPTR), DHCP, PPPoE, TELNET, TFTP, NTP, STUN, SIMPLE, LLDP, LDAP, TR-069, 802.1x, TLS, SRTP, IPV6
Network Interfaces	Dual switched auto-sensing 10/100/1000 Mbps Gigabit Ethernet ports with integrated PoE
Graphic Display	2.8 inch (320x240) TFT color LCD
Bluetooth	Yes, integrated
Wi-Fi	Yes, integrated dual-band Wi-Fi 802.11 a/b/g/n/ac (2.4Ghz & 5Ghz)
Feature Keys	8 line keys with up to 12 SIP accounts, 10 MPK extension keys with paper slot, 4 XML programmable context-sensitive softkeys, 5 navigation/menu keys, 9 dedicated function keys for MESSAGE(with LED indicator), TRANSFER, HEADSET, MUTE, SEND/REDIAL, SPEAKERPHONE, VOL+, VOL
Voice Codec	Support for G.729A/B, G.711µ/a-law, G.726, G.722(wide-band), G.723, iLBC, OPUS,in-band and out-of-band DTMF(in audio, RFC2833, SIP INFO)
Auxiliary Ports	RJ9 headset jack allowing EHS with Plantronics headsets, USB to support Grandstream's GUV Series headsets, and other USB headsets
Telephony Features	Hold, transfer, forward, 5-way conference, call park, call pickup, shared-call appearance(SCA)/bridged-line-appearance(BLA), downloadable phonebook(XML, LDAP, up to 2000 items), call waiting, call log(up to 2000 records), XML customization of the screen, off-hook auto dial, auto answer, click-to-dial, flexible dial plan, hot-desking, personalized music ringtones and music on hold, server redundancy and fail-over
HD audio	Yes, HD handset and speakerphone with support for wideband audio. Dual Microphone.
Extension Module	No
Base Stand	Yes, 2 angle positions available, Wall Mountable (Wall Mount *sold separately)
QoS	Layer 2 QoS (802.1Q, 802.1P) and Layer 3 (ToS, DiffServ, MPLS) QoS
Security	User and administrator-level passwords, MD5 and MD5-sess-based authentication, 256-bit AES encrypted configuration file, SRTP, TLS, 802.1x media access control, secure boot.

Multi-language	<p>LCD Language: English 简体中文 (Simplified Chinese) العربية (Arabic) Català (Catalan) Čeština (Czech) Deutsch (German) Ελληνικά (Greek) Español (Spanish) Français (French) עברית (Hebrew) Hrvatski (Croatian) Magyar (Hungarian) Italiano (Italian) 日本語 (Japanese) 한국어 (Korean) Latviešu valoda (Latvian) Nederlands (Dutch) Polski (Polish) Português (Portuguese) Русский (Russian) Svenska (Swedish) Slovenščina (Slovenian) Slovenčina (Slovak) Türkçe (Turkish) Українська (Ukrainian) 正體中文 (Traditional Chinese)</p> <p>WebUI Language: English 简体中文 (Simplified Chinese) العربية (Arabic) Čeština (Czech) Deutsch (German) Español (Spanish) Français (French) עברית (Hebrew) Hrvatski (Croatian) Magyar (Hungarian) Italiano (Italian) 日本語 (Japanese) 한국어 (Korean) Nederlands (Dutch) Polski (Polish) Português (Portuguese) Русский (Russian) Slovenščina (Slovenian) Türkçe (Turkish) 繁體中文 (Traditional Chinese)</p>
Upgrade/Provisioning	Firmware upgrade via FTP/TFTP / HTTP / HTTPS, mass provisioning using GDMS/TR069 or AES encrypted XML configuration file.
Power & Green Energy Efficiency	<p>Universal power adapter included: Input:100-240V ; Output: +12V, 1A ; Integrated Power-over-Ethernet (802.3af) Max power consumption 9.5W (power adapter) or 10.8W (PoE)</p>
Temperature and Humidity	<p>Operation: 0°C to 40°C Storage: -10°C to 60°C Humidity: 10% to 90% non-condensing</p>
Package Content	GRP2634 phone, handset with cord, phone stand, 12V power adapter, network cable, Quick Installation Guide, GPL license
Physical	<p>Dimension: 220mmx 210mmx 82mm Unit Weight: 880g ; Package Weight:1260g</p>
Compliance	<p>FCC: Part 15 (CFR 47) Class B CE: EN55022 Class B; EN55024 Class B;EN61000-3-2; EN61000-3-3;EN60950-1 RCM: AS/ACIF S004; AS/NZS CISPR22/24; AS/NZS 60950.1</p>

GRP2634 Technical Specifications

Protocols/Standards	SIP RFC3261, TCP/IP/UDP, RTP/RTCP, HTTP/HTTPS, ARP, ICMP, DNS(A record, SRV,NAPTR), DHCP, PPPoE, TELNET, TFTP, NTP, STUN, SIMPLE, LLD, LDAP, TR-069, 802.1x, TLS, SRTP, IPV6
Network Interfaces	Dual switched auto-sensing 10/100/1000 Mbps Gigabit Ethernet ports with integrated PoE
Graphic Display	4.3inch(480x272) TFT color LCD
Bluetooth	Yes, integrated
Wi-Fi	Yes, integrated dual-band Wi-Fi 802.11 a/b/g/n/ac (2.4Ghz & 5Ghz)
Feature Keys	12 line keys with up to 16 SIP accounts, 24MPK extension keys with paper slot, 5 XML programmable context-sensitive softkeys, 5 navigation/menu keys, 8 dedicated function keys for: MESSAGE(with LED indicator), TRANSFER, HEADSET, HOLD,MUTE, SEND/REDIAL, SPEAKERPHONE, VOL+, VOL
Voice Codec	Support for G7.29A/B, G.711μ/a-law, G.726, G.722(wide-band), G723, iLBC, OPUS, inband and out-of-band DTMF(in audio, RFC2833, SIP INFO)

Auxiliary Ports	RJ9 headset jack allowing EHS with Plantronics headsets, USB to support Grandstream's GUV Series headsets and other USB headsets
Telephony Features	Hold, transfer, forward, 5-way conference, call park, call pickup, shared-call appearances(SCA)/bridged-line-appearance(BLA), downloadable phonebook(XML, LDAP, up to 2000 items), call waiting, call log(up to 2000 records), XML customization of the screen, off-hook auto dial, auto answer, click-to-dial, flexible dial plan, hot-desking, personalized music ringtones and music on hold, server redundancy, and fail-over
HD audio	Yes, HD handset and speakerphone with support for wideband audio. Dual Microphone.
Extension Module	Yes
Base Stand	Yes, 2 angle positions available, Wall Mountable (Wall Mount *sold separately)
QoS	Layer 2 QoS (802.1Q, 802.1P) and Layer 3 (ToS, DiffServ, MPLS) QoS
Security	User and administrator-level passwords, MD5 and MD5-sess-based authentication, 256-bit AES encrypted configuration file, SRTP, TLS, 802.1x media access control, secure boot.
Multi-language	LCD Language: English 简体中文 (Simplified Chinese) العربية (Arabic) Català (Catalan) Čeština (Czech) Deutsch (German) Ελληνικά (Greek) Español (Spanish) Français (French) עברית (Hebrew) Hrvatski (Croatian) Magyar (Hungarian) Italiano (Italian) 日本語 (Japanese) 한국어 (Korean) Latviešu valoda (Latvian) Nederlands (Dutch) Polski (Polish) Português (Portuguese) Русский (Russian) Svenska (Swedish) Slovenščina (Slovenian) Slovenčina (Slovak) Türkçe (Turkish) Українська (Ukrainian) 正體中文 (Traditional Chinese) WebUI Language: English 简体中文 (Simplified Chinese) العربية (Arabic) Čeština (Czech) Deutsch (German) Español (Spanish) Français (French) עברית (Hebrew) Hrvatski (Croatian) Magyar (Hungarian) Italiano (Italian) 日本語 (Japanese) 한국어 (Korean) Nederlands (Dutch) Polski (Polish) Português (Portuguese) Русский (Russian) Slovenščina (Slovenian) Türkçe (Turkish) 繁體中文 (Traditional Chinese)
Upgrade/Provisioning	Firmware upgrade via FTP/TFTP/TFTPS/HTTP/HTTPS, mass provisioning using GDMS/TR-069 or AES encrypted XML configuration file.
Power & Green Energy Efficiency	Universal power adapter included: Input:100-240V ; Output: +12V, 1A ; Integrated Power-over-Ethernet(802.3af) Max power consumption 3.2W(power adapter) or 4.3W(PoE)
Temperature and Humidity	Operation: 0°C to 40°C Storage: -10°C to 60°C Humidity: 10% to 90% non-condensing
Package Content	GRP2636 phone, handset with cord, phone stand, 12V power adapter, network cable, Quick Installation Guide, GPL license
Physical	Dimension: 220mmx 210mmx 82mm Unit Weight: 880g ; Package Weight:1260g

Compliance	<p>FCC: FCC Part 15 Class B; FCC Part 15 Subpart C,15.247; FCC Part 15 Subpart E,15.407; FCC Part 68 HAC.</p> <p>CE: ETSI EN 301 893; ETSI EN 301 489-1/-17; ETSI EN 300 328; EN IEC 62311; EN 55032; EN 55035; EN 62368-1.</p> <p>IC: RSS-247 Issue 2; RSS-Gen Issue 5; ICES-003 Issue 7; CS-03, Part V.</p> <p>RCM: AS/NZS CISPR32; AS/NZS 4268; AS/NZS 2772.2; AS/NZS 62368.1; AS/CA S004.</p> <p>UKCA: ETSI EN 301 893; ETSI EN 301 489-1/-17; ETSI EN 300 328; BS EN IEC 62311; BS EN 55032; BS EN 55035; BS EN 62368-1.</p>
-------------------	---

GRP2636 Technical Specifications

Protocols/Standards	SIP RFC3261, TCP/IP/UDP, RTP/RTCP/RTCP-XR, HTTP/HTTPS, ARP, ICMP, DNS (A record, SRV, NAPTR), DHCP, PPPoE, SSH, TFTP, FTP/FTPS, NTP, STUN, SIMPLE, LLDP, LDAP, TR-069, 802.1x, TLS, SRTP, IPv6
Network Interfaces	Dual switched auto-sensing 10/100/1000 Mbps Ethernet ports with integrated PoE
Graphic Display	7" (1042x600) capacitive touch TFT color LCD
Bluetooth	Yes, integrated
Wi-Fi	Yes, integrated dual-band Wi-Fi 802.11 a/b/g/n/ac (2.4Ghz & 5Ghz)
Feature Keys	12 line keys with up to 16 SIP accounts, 5 navigation/menu keys, 9 dedicated function keys for MESSAGE (with LED indicator), TRANSFER, HOLD, HEADSET, MUTE, SEND/REDIAL, SPEAKERPHONE, VOL+, VOL-
Voice Codec	Support for G.729A/B, G.711μ/a-law, G.726, G.722 (wide-band), OPUS, iLBC and in-band and out-of-band DTMF (in audio, RFC2833, SIP INFO)
Auxiliary Ports	RJ9 headset jack allowing EHS with Plantronics headsets, USB port
Telephony Features	Hold, transfer, forward, 5-way conference, call park, call pickup, shared-call appearance (SCA) / bridged line appearance (BLA), downloadable phonebook (XML, LDAP, up to 2000 items), call waiting, call log(up to 2000 records), XML customization of screen, off-hook auto dial, auto answer, click-to-dial, flexible dial plan, hot-desking, personalized music ringtones and music on hold, server redundancy and fail-over
HD audio	Yes, HD handset and speakerphone with support for wideband audio, and dual microphone.
Extension Module	Yes
Base Stand	Yes, 2 angle positions available, Wall Mountable (Wall Mount *sold separately)
QoS	Layer 2 QoS (802.1Q, 802.1P) and Layer 3 (ToS, DiffServ, MPLS) QoS
Security	User and administrator level passwords, MD5 and MD5-sess based authentication, 256-bit AES encrypted configuration file, SRTP, TLS, 802.1x media access control, secure boot.
Multi-language	<p>LCD Language: English 简体中文 (Simplified Chinese) العربية (Arabic) Català (Catalan) Čeština (Czech) Deutsch (German) Ελληνικά (Greek) Español (Spanish) Français (French) עברית (Hebrew) Hrvatski (Croatian) Magyar (Hungarian) Italiano (Italian) 日本語 (Japanese) 한국어 (Korean) Latviešu valoda (Latvian) Nederlands (Dutch) Polski (Polish) Português (Portuguese) Русский (Russian) Svenska (Swedish) Slovenščina (Slovenian) Slovenčina (Slovak) Türkçe (Turkish) Українська (Ukrainian) 正體中文 (Traditional Chinese)</p> <p>WebUI Language: English 简体中文 (Simplified Chinese) العربية (Arabic) Čeština (Czech) Deutsch (German) Español (Spanish) Français (French) עברית (Hebrew) Hrvatski (Croatian) Magyar (Hungarian) Italiano (Italian) 日本語 (Japanese) 한국어 (Korean) Nederlands</p>

	(Dutch) Polski (Polish) Português (Portuguese) Русский (Russian) Slovenščina (Slovenian) Türkçe (Turkish) 繁體中文 (Traditional Chinese)
Upgrade/Provisioning	Firmware upgrade via TFTP/HTTP/HTTPS/FTP/FTPS, mass provisioning using GDMS/TR-069, or AES encrypted XML configuration file.
Power & Green Energy Efficiency	Universal power adapter included: Input: 100-240V. Output: +12V, 1A. Integrated Power-over-Ethernet (802.3af) Max power consumption 6.5W (power adapter)
Temperature and Humidity	Operation: 0°C to 40°C Storage: -10°C to 60°C Humidity: 10% to 90% non-condensing
Package Content	GRP2670 phone, handset with cord, phone stand, 12V power adapter, network cable, Quick Installation Guide
Compliance	FCC: Part 15 Subpart B(Class B), Part 15 Subpart C 15.247, Part 15 Subpart C 15.407, Part 1 Subpart I, Part 68. 316/317. IC: RSS-247, RSS-Gen, RSS-102, ICES-003, CS-03 Part V; CE: EN 55032, EN 55035, EN 61000-3-2, EN 61000-3-3, EN 62368-1, EN 62311, EN 301 489-1, EN 301 489-17, EN 300 328, EN 301 893; RCM: AS/NZS CISPR 32, AS/NZS 62368.1, AS/NZS 4268, AS NZS 2772.2, AS/CA S004.

GRP2670 Technical Specifications

Protocols/Standards	SIP RFC3261, TCP/IP/UDP, RTP/RTCP, HTTP/HTTPS, ARP, ICMP, DNS(A record, SRV, NAPTR), DHCP, PPPoE, SSH, TFTP, NTP, STUN, SIMPLE, LLDP, LDAP, TR-069, 802.1x, TLS, SRTP, IPV6
Network Interfaces	Dual switched auto-sensing 10/100/1000 Mbps Gigabit Ethernet ports with integrated PoE
Graphic Display	5.0 inch (1280x720) TFT color LCD
Wi-Fi	Yes, integrated dual-band WiFi 802.11 a/b/g/n/ac (2.4Ghz & 5Ghz)
Bluetooth	Yes, integrated
Feature Keys	14 line keys with up to 16 SIP accounts, 6 XML programmable context-sensitive softkeys, 5 navigation/menu keys, 9 dedicated function keys for: MESSAGE (with LED indicator), TRANSFER, HOLD, HEADSET, MUTE, SEND/REDIAL, SPEAKERPHONE, VOL+, VOL-
Voice Codec	Support for G.729A/B, G.711µ/a-law, G.726-32, G.722(wide-band), G723.1, iLBC, OPUS, in-band and out-of-band DTMF(in audio, RFC2833, SIP INFO)
Auxiliary Ports	RJ9 headset jack (allowing EHS with Plantronics headsets), USB
Telephony Features	Hold, transfer, forward, 5-way conference, call park, call pickup, shared-callappearance (SCA)/bridged-line-appearance (BLA), downloadable phonebook(XML, LDAP, up to 2000 items), call waiting, call log(up to 2000 records), XML customization of screen, off-hook auto dial, auto answer, click-to-dial, flexible dial plan, hot-desking, personalized music ringtones and music on hold, server redundancy and fail-over
HD audio	Yes, HD handset and speakerphone with support for wideband audio, and dual microphone

Extension Module	Yes, GBX20
Base Stand	Yes, allow 2 angle positions
Wall Mountable	Yes, (*wall mount sold separately)
QoS	Layer 2 QoS (802.1Q, 802.1P) and Layer 3 (ToS, DiffServ, MPLS) QoS
Security	User and administrator level passwords, MD5 and MD5-session based authentication, 256-bit AES encrypted configuration file, SRTP, TLS, 802.1x media access control, secure boot
Multi-language	<p>LCD Language: English 简体中文 (Simplified Chinese) العربية (Arabic) Català (Catalan) Čeština (Czech) Deutsch (German) Ελληνικά (Greek) Español (Spanish) Français (French) עברית (Hebrew) Hrvatski (Croatian) Magyar (Hungarian) Italiano (Italian) 日本語 (Japanese) 한국어 (Korean) Latviešu valoda (Latvian) Nederlands (Dutch) Polski (Polish) Português (Portuguese) Русский (Russian) Svenska (Swedish) Slovenščina (Slovenian) Slovenčina (Slovak) Türkçe (Turkish) Українська (Ukrainian) 正體中文 (Traditional Chinese)</p> <p>WebUI Language: English 简体中文 (Simplified Chinese) العربية (Arabic) Čeština (Czech) Deutsch (German) Español (Spanish) Français (French) עברית (Hebrew) Hrvatski (Croatian) Magyar (Hungarian) Italiano (Italian) 日本語 (Japanese) 한국어 (Korean) Nederlands (Dutch) Polski (Polish) Português (Portuguese) Русский (Russian) Slovenščina (Slovenian) Türkçe (Turkish) 繁體中文 (Traditional Chinese)</p>
Upgrade/Provisioning	Firmware upgrade via FTP/TFTP / HTTP / HTTPS, mass provisioning using GDMS/TR069 or AES encrypted XML configuration file
Power & Green Energy Efficiency	<p>Universal power adapter included: Input:100-240V ; Output: +12V, 1.0A ; Integrated Power-over-Ethernet(802.3af) Max power consumption 6.2W(power adapter)</p>
Physical	<p>Unit weight:1050g ; Package weight:1620g Dimension: 263mm x 210mm x 82mm</p>
Temperature and Humidity	<p>Operation: 0°C to 40°C Storage: -10°C to 60°C Humidity: 10% to 90% Non-condensing</p>
Package Content	GRP2650 phone, handset with cord, phone stand, 12V power adapter, network cable, Quick Installation Guide
Compliance	<p>FCC: Part 15 (CFR 47) Class B CE: EN55022 Class B; EN55024 Class B;EN61000-3-2; EN61000-3-3;EN60950-1 RCM: AS/ACIF S004; AS/NZS CISPR22/24; AS/NZS 60950.1</p>

GRP2650 Technical Specifications

GETTING STARTED

This chapter provides basic installation instructions including the list of the packaging contents and also information for obtaining the best performance with the GRP261x/GRP2624/GRP2634 phone.

Equipment Packaging

GRP261x/GRP2624/GRP263x/GRP2670/GRP2650

- 1 x GRP261x/GRP2624/GRP263x/GRP2670/GRP2650 Main Case.
- 1 x Handset.
- 1 x Phone Stand.
- 1 x Ethernet Cable.
- 1 x Power Adapter.
- 1 x Phone cord.
- 1 x Quick Installation Guide.

Equipment Packaging

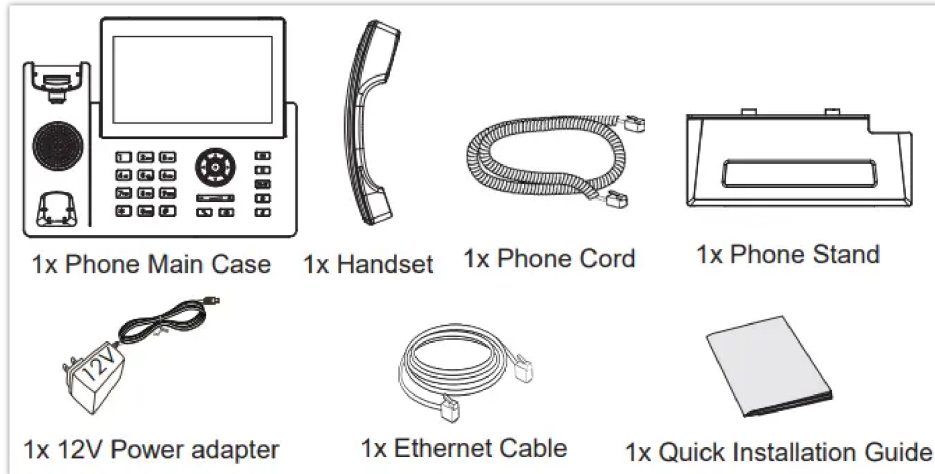

GRP261X/GRP2624/GRP2634 Package Content (GRP2670 as an example)

Note

Check the package before installation. If you find anything missing, contact your system administrator.

GRP261X/GRP2624/GRP263x/GRP2670/GRP2650 Phone Setup

The GRP261X/GRP2624/GRP263x/GRP2670/GRP2650 phones can be installed on the desktop using the phone stand or attached to the wall using the slots for wall mounting.

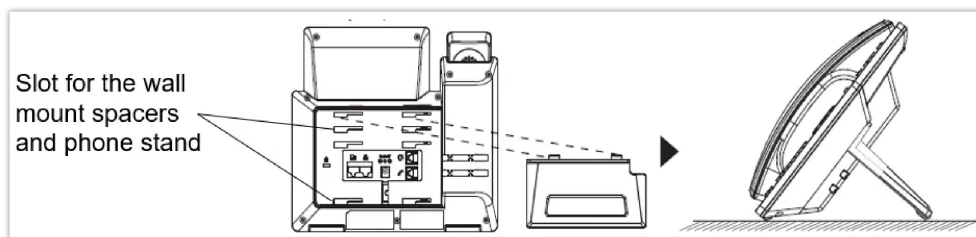

Phone Stand and Mounting Slots on the GRP261X/GRP2624/GRP2634/GRP2670

Using the Phone Stand

For installing the phone on the table with the phone stand, attach the phone stand to the bottom of the phone where there is a slot for the phone stand. (Upper half, bottom part).

Using the Slots for Wall Mounting

1. Attach the wall mount spacers to the slot for wall mount spacers on the back of the phone.
2. Attach the phone to the wall via the wall mount hole.
3. Pull out the tab from the handset cradle (See figure below).

4. Rotate the tab and plug it back into the slot with the extension up to hold the handset while the phone is mounted on the wall (see figure below).

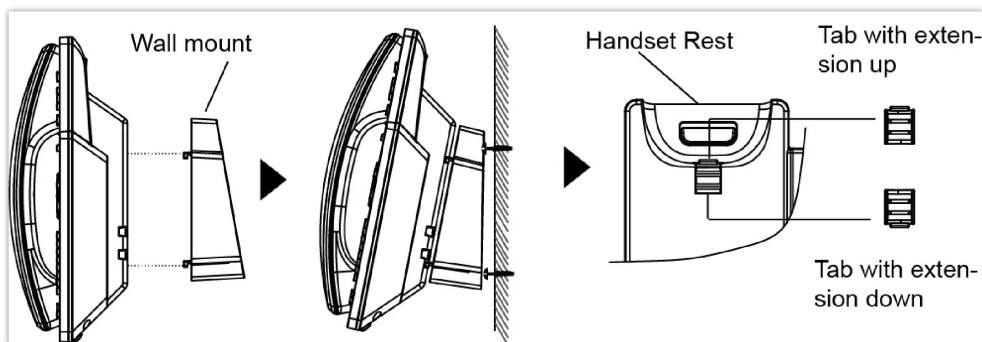

Tab on the Handset Cradle

Connecting the GRP261X/GRP2624/GRP263x/GRP2670/GRP2650

To set up the GRP261X/GRP2624/GRP263x/GRP2670/GRP2650, follow the steps below:

1. Connect the handset and main phone case with the phone cord.
2. Connect the LAN port of the phone to the RJ-45 socket of a hub/switch or a router (LAN side of the router) using the Ethernet cable.
3. Connect the PSU output plug to the power jack on the phone; plug the power adapter into an electrical outlet. If a PoE switch is used in step 2, this step could be skipped.
4. The LCD will display provisioning or firmware upgrade information. Before continuing, please wait for the date/time display to show up.
5. Using the phone-embedded web server or keypad configuration menu, you can further configure the phone using either a static IP or DHCP.

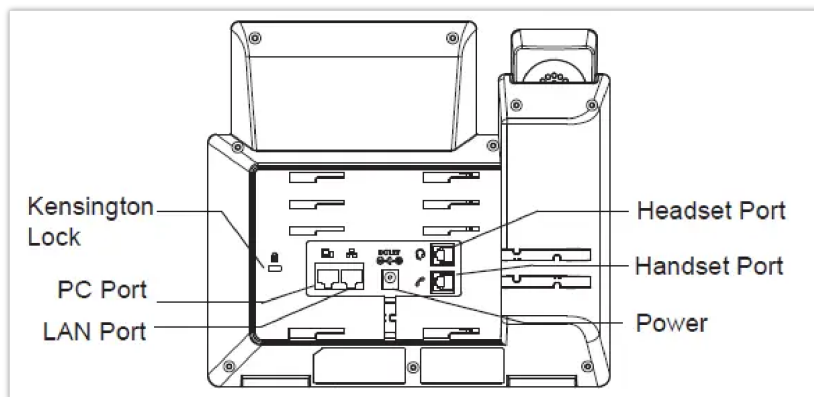

GRP261X/GRP2624/GRP263x/GRP2670/GRP2650 Back / Side View

Note

- For easy deployment, GRP2612W/GRP2614/GRP2615/GRP2616/GRP2624/GRP263x/GRP2670/GRP2650 out of the box is preconfigured to connect to a default SSID named wp_master with a password (WPA/WPA2 PSK) equal to **wp!987@dmIn**, for this to work the following criteria needs to be met:
 1. The IP phone should not be connected by a LAN cable.
 2. No SIP account should be registered on the IP phone.
 3. SSIDs from previous connections should not be saved on the IP phone, please factory reset the unit to confirm.

Configuration via Keypad

To configure the LCD menu using the phone's keypad, follow the instructions below:

- **Enter MENU options.** When the phone is idle, press the round MENU button to enter the configuration menu.
- Navigate to the menu options. Press the arrow keys up/down/left/right to navigate to the menu options.
- Enter/Confirm selection. Press the round MENU button or "Select" Softkey to enter the selected option.
- Exit. Press "Exit" Softkey to exit the previous menu.
- **Return to Home page.**

In the Main menu, press Home Softkey to return home screen.

In the sub-menu, press and hold the "Exit" Softkey until Exit Softkey changes to Home Softkey, then release the Softkey.

- The phone automatically exits MENU mode with an incoming call, when the phone is off-hook or the MENU mode if left idle for more than 60 seconds.
- When the phone is idle, pressing and holding the UP-navigation key for 3 seconds can see the phone's IP address, IP setting, MAC address, and software address.

The MENU options are listed in the following table.

User Level	User	Password	Web Pages Allowed
End User Level	user	123	Only Status and Basic Settings
Administrator Level	admin	Random password available on the sticker at the back of the unit.	Browse all pages

Configuration Menu

The following picture shows the keypad MENU configuration flow:

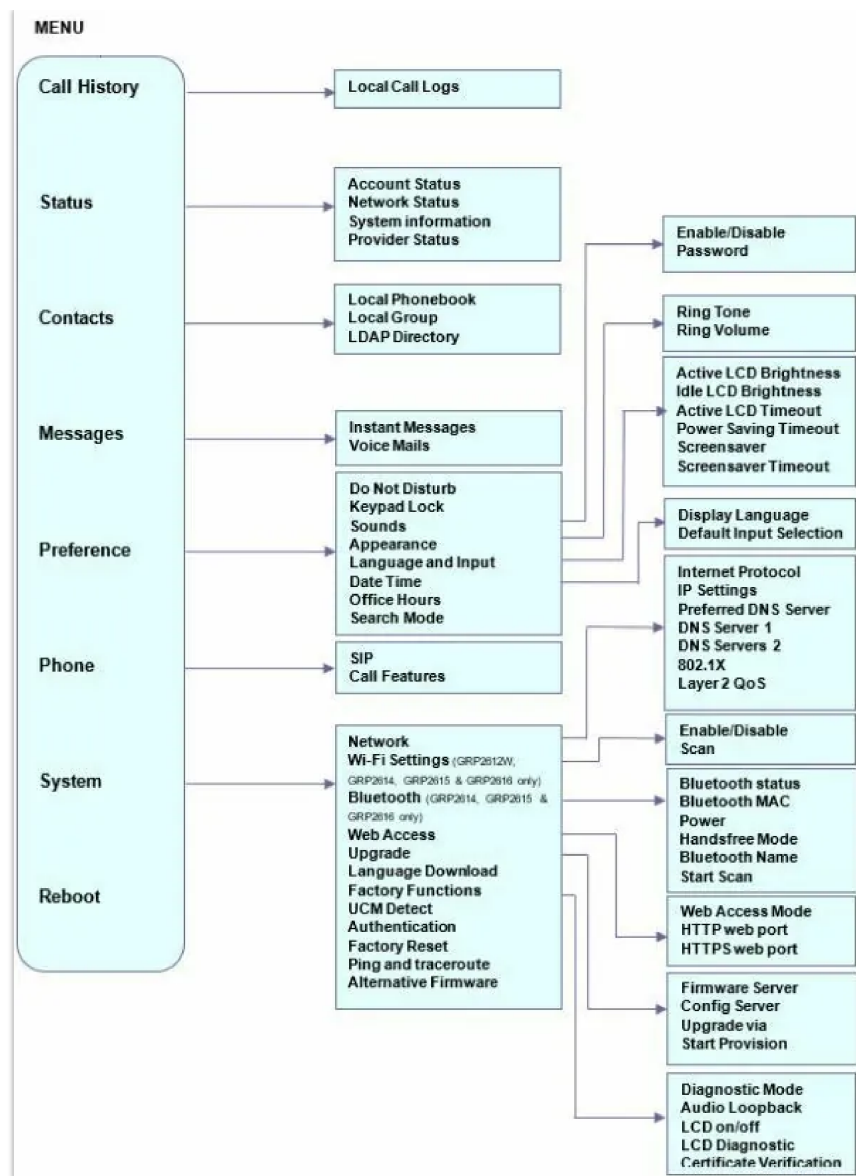

Configuration via Web Browser

The GRP261X/GRP2624/GRP263x/GRP2670/GRP2650 embedded Web server responds to HTTP/HTTPS GET/POST requests. Embedded HTML pages allow a user to configure the IP phone through a Web browser such as Google Chrome, Mozilla Firefox, and Microsoft's IE. To access the Web GUI:

1. Connect the computer to the same network as the phone.
2. Make sure the phone is turned on and shows its IP address. You may check the IP address by pressing and holding the UP arrow button for 3 seconds when the phone is in an idle state.
3. Open a Web browser on your computer.
4. Enter the phone's IP address in the address bar of the browser.
5. Enter the administrator's login and password to access the Web Configuration Menu.

Notes

- The computer must be connected to the same sub-network as the phone. This can be easily done by connecting the computer to the same hub or switch as the phone is connected. In the absence of a hub/switch (or free ports on the hub/switch), please connect the computer directly to the PC port on the back of the phone.
- If the phone is properly connected to a working Internet connection, the IP address of the phone will display in MENU→Status→Network Status. This address has the format: xxx.xxx.xxx.xxx, where xxx stands for a number from 0-255. Users will need this number to access the Web GUI. For example, if the phone has an IP address of 192.168.40.154, please enter "http://192.168.40.154" in the address bar of the browser.

There are two default passwords for the login page:

User Level	User	Password	Web Pages Allowed
End User Level	user	123	Only Status and Basic Settings
Administrator Level	admin	Random password available on the sticker at the back of the unit.	Browse all pages

When changing any settings, always SUBMIT them by pressing the "Save" or "Save and Apply" button at the bottom of the page. If the change is saved only but not applied, after making all the changes, click on the "APPLY" button on the top of the page to submit. After submitting the changes in all the Web GUI pages, reboot the phone to have the changes take effect if necessary (All the options under the "Accounts" page and "Phonebook" page do not require a reboot. Most of the options under "Settings" page do not require a reboot).

Accessing the Web UI via LCD

To log in to the GRP261x Web UI from the LCD, please follow these steps based on the access level:

Note:

Ensure proper security settings are configured to prevent unauthorized access to the device's configuration.

Admin Login fom LCD

The admin login method is used when accessing the Web UI for the first time or after a factory reset, as the default password is initially set.

1. **Access the IP Address:** Enter the phone's IP address into a web browser.
2. **Click on "Login from LCD":** This will generate a one-time access code.



Welcome to GRP2634

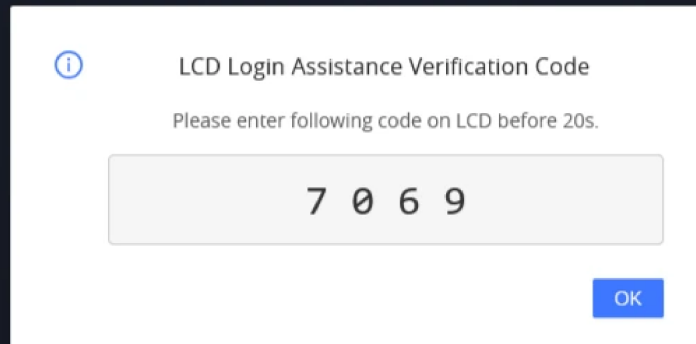

Login From LCD

3. **Enter the Code on the LCD:** Using the phone's keypad, navigate to the login prompt on the LCD screen and enter the code.
4. **Select "AdminLogin":** Confirm the entry on the LCD to gain admin access to the web interface.

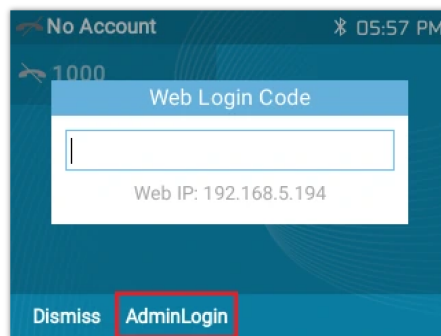

Note:

If configuration via the keypad menu is unrestricted, any user can modify all settings directly from the LCD menu with admin privileges, bypassing the web UI password requirement.

User Login from LCD

User-level access requires the option "Enable User Web Access" to be enabled in the phone's security settings (disabled by default).

Note:

The "Login from LCD" method allows authentication without a preset password, provided the user has physical access to the phone.

1. **Enable User Web Access :** This must first be configured in the admin settings.

Security Settings

Web/SSH Access **User Info Management** Client Certificate Trusted CA Certificates Keypad Lock

Test Password Strength

Enable User Web Access

New User Password

Confirm User Password

Admin Password

Current Password

New Password

Confirm Password

Save

2. **Access the IP Address:** Open the phone's IP address in a web browser.
3. **Click on "Login from LCD":** This will generate a one-time access code.

Welcome to GRP2634

Login

Login From LCD

Welcome to GRP2634

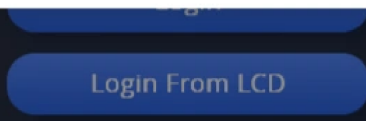
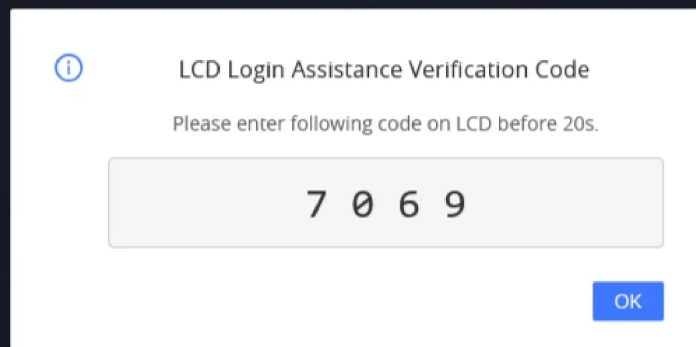

4. **Enter the Code on the LCD:** Input the displayed code using the phone's keypad on the LCD login prompt.
5. **Select "UserLogin":** Confirm the entry on the LCD to access the user-level web interface.

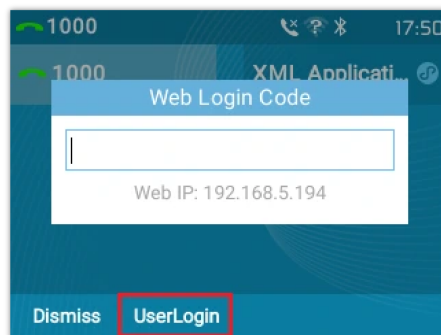

Remote Access to Web UI through GDMS

The GRP261x/GRP262x/GRP263x/GRP2650/GRP2670 IP phones introduces enhanced remote management capabilities by enabling remote access to the phone's Web UI via Grandstream Device Management System (GDMS).

Before proceeding, ensure that the target GRP26xx phone is added under "**VoIP Device**" in your GDMS account and is running firmware version **1.0.13.21 or higher**.

A screenshot of the GDMS VoIP Device management page. It shows a table of devices with columns for MAC Address, Device Name, Device Model, Firmware Version, Account Status, Site Name, Push Configuration, Last Config Time, and Options. The "Firmware Version" column for the first device is highlighted with a red box.

MAC Address	Device Name	Device Model	Firmware Version	Account Status	Site Name	Push Configuration	Last Config Time	Options
CO:74AD:...	GRP2634	GRP2634	1.0.13.21	1000	Default	Enabled	2025/04/02 16:54	[Icons]

GDMS VoIP Device Page

To remotely access the phone's web UI, hover over "**Additional Options**" and select "**Remote Access to Web UI**".

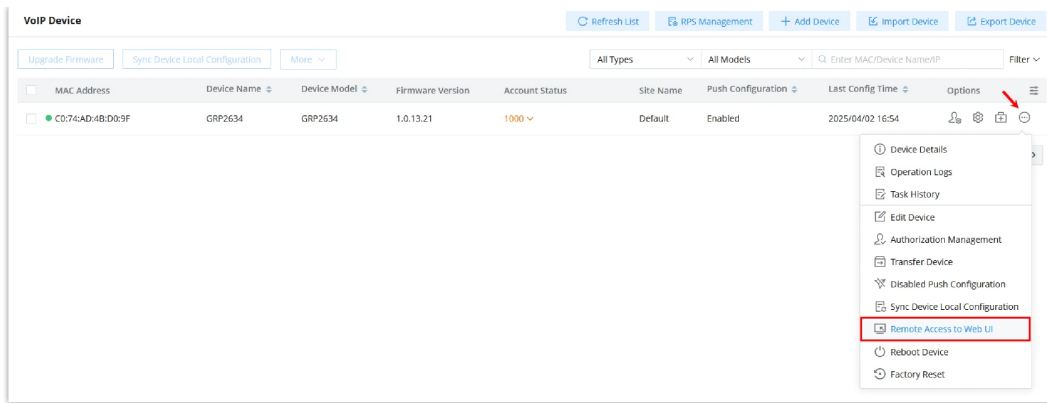

Remote Access to Web UI via GDMS

A window will appear, informing you of temporary access (1 hour), and you will be redirected to the web UI.

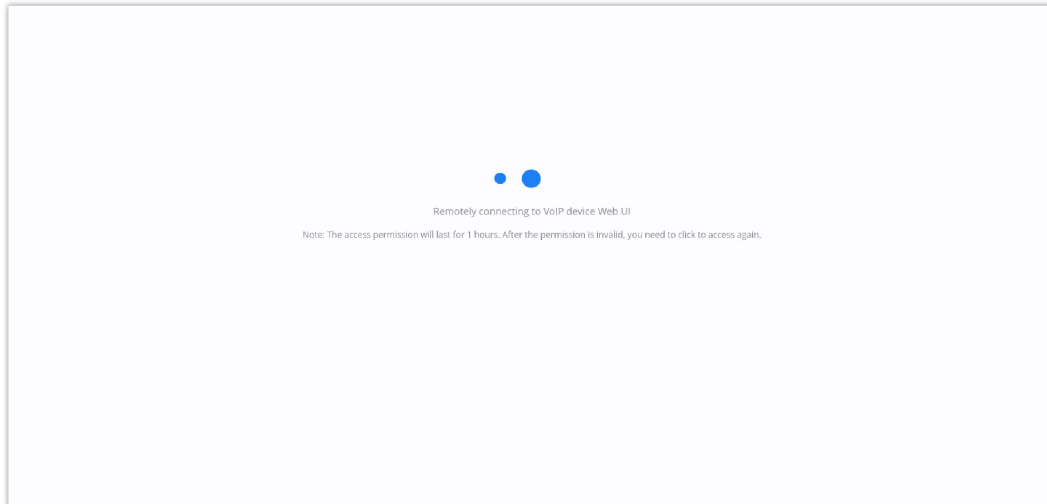

Remotely Connecting to the GRP Phone



GRP2634 Web UI Login Page

Saving Configuration Changes

After users make changes to the configuration, pressing the "Save" button will save but not apply the changes until the "Apply" button on the top of the web GUI page is clicked. Or, users could directly press the "Save and Apply" button. We recommend rebooting or powering cycle the phone after applying all the changes.

Rebooting from Remote Locations

Press the "Reboot" button on the top right corner of the web GUI page to reboot the phone remotely. The web browser will then display a reboot message. Wait for about 1 minute to log in again.

CONFIGURATION GUIDE

This section describes the options in the phone's Web GUI. As mentioned, you can log in as an administrator or an end-user.

- **Status:** Displays the Account status, Network status, and System Info of the phone.
- **Account:** To configure the SIP account.
- **Settings:** To configure call features, ring tone, audio control, LCD display, date and time, Web services, XML applications, programmable keys, etc.
- **Network:** To configure network settings.
- **Maintenance:** To configure web access, upgrading, provisioning, Syslog, language settings, TR-069, security, etc.
- **Directory:** To manage Phonebook and LDAP.

Status Page Definitions

Status → Account Status	
Account	<p>Account index.</p> <ul style="list-style-type: none"> ● For GRP2610/GRP2610P: up to 2 SIP accounts. ● For GRP2611G: up to 3 SIP accounts. ● For GRP2612/GRP2612P/GRP2612W/GRP2612G: up to 4 SIP accounts and up to 2 accounts for legacy hardware. ● For GRP2613: up to 4 SIP accounts and up to 3 accounts for legacy hardware. ● For GRP2614: up to 12 SIP accounts. ● For GRP2615: up to 16 SIP accounts. ● For GRP2616: up to 16 SIP accounts. ● For GRP2624: up to 12 SIP accounts. ● For GRP2634: up to 12 SIP accounts. ● For GRP2636: up to 16 SIP accounts. ● For GRP2650: up to 16 SIP accounts. ● For GRP2670: up to 16 SIP accounts.
SIP User ID	Displays the configured SIP User ID for the account.
SIP Server	Displays the configured SIP Server address, URL or IP address, and port of the SIP server.
SIP Registration	Displays SIP registration status for the SIP account.
Status → Network Status	
MAC Address	Global unique ID of device, in HEX format. The MAC address will be used for provisioning and can be found on the label coming with original box and on the label located on the back of the device.
IP Setting	The configured address type: DHCP, Static IP or PPPoE.
IPv4 Address	The IPv4 address obtained on the phone.
IPv6 Address	The IPv6 address obtained on the phone.
OpenVPN® IP	The OpenVPN® IP obtained on the phone.
Subnet Mask	The subnet mask obtained on the phone.

Gateway	The gateway address obtained on the phone.
DNS Server 1	The DNS server address 1 obtained on the phone.
DNS Server 2	The DNS server address 2 obtained on the phone.
Affinity Broadcast	The status of Affinity Broadcast on the phone. (Available on GRP2614, GRP2615, GRP2616, GRP2624, GRP2634, GRP2670 & GRP2650 only).
PPPoE Link Up	PPPoE connection status.
NAT Type	The type of NAT connection used by the phone.
NAT Traversal	Display the status of NAT connection for each account on the phone.
Status → System Info	
Product Model	Product model of the phone.
Part Number	Product part number.
Serial Number	Displays the Serial Number of the unit.
Certificate Type	Displays the certificate type used for encryption
Software Version	<ul style="list-style-type: none"> ● Boot: boot version number. ● Core: core version number. ● Prog: program version number. This is the main firmware release number, which is always used for identifying the software system of the phone. ● GUI: The GUI version used by the phone ● Res: recovery version number.
IP Geographic Information	<ul style="list-style-type: none"> ● Country Code: displaying country code for Wi-Fi; (Available on GRP2612W, GRP2614, GRP2615, GRP2616, GRP2624, GRP2634, GRP2636, GRP2670 & GRP2650 only). ● City: displaying phone location. ● Language: displaying language. ● Recommended Time Zone: displaying time zone
System Up Time	System up time since the last reboot.
System Time	Current system time on the phone system.
System Time Zone	Displays the current system time zone
Service Status	GUI and Phone service status.
System Information	Download system information
User Space	Shows the percentage of the user space used and the status of the Database
Core Dump	Shows the status of the core dump and the core dump files generated if any. It also gives the ability to generate GUI/Phone core dump files manually.
Screenshot	Download captured screenshots.

	Press “Start” button to clear screenshots.
Special Feature	OpenVPN® Support: displaying if the phone supports OpenVPN®.
Status → Call Status	
Display the calls status. Refer to [Maintenance > Voice Monitoring > Display Report]	
Status → Programmable Keys Status → Multi-Purpose Keys Status	
MPKs Status	<ul style="list-style-type: none"> • Mode • Account • Description • Value
Status → Programmable Keys Status → Virtual Multi-Purpose Keys Status	
VPKs Status	<ul style="list-style-type: none"> • Mode • Account • Description • Value
Status → Programmable Keys Status → Softkeys Status	
Softkeys	<ul style="list-style-type: none"> • Mode • Account • Description • Value
Status → Extension Boards Status (GRP2615 & GRP2650 & GRP2670 only)	
Extension (1-4) Keys	<p>EXT (1-160):</p> <ul style="list-style-type: none"> • Mode • Account • Description • Value
Status → Call Feature Status	
Accounts	<ul style="list-style-type: none"> • DND • Auto Answer • Forward All • Busy Forward • Delay Forward
Status → Energy Saving	
Current Hours	Displays whether it is Office Hours or Non-Office Hours configuration.
Energy Saving Mode	Displays the Energy Saving mode.
Idle Time Tracking	Displays Energy Saving Feedback for achieved energy savings. By showing the duration that the phone has been powered up.

Status → Energy Saving → Applied Energy Saving Config	
Backlight Brightness: Active	Displays the LCD brightness when the phone is active. Valid range is 10 to 100 where 100 is the brightest.
Backlight Brightness: Idle	Displays the LCD brightness when the phone is idle. Valid range is 0 to 100 where 0 is off and 100 is the brightest.
Active Backlight Timeout	Displays active backlight timeout (in minutes). The valid range is 0 to 90.
Blank Screen Timeout	Displays The actual applied power saving timeout value under Standard, Maximum, or Customized Mode
Enable Missed Call Backlight	If set to "Yes", LCD backlight will be turned on when there is a missed call on the phone.
Enable IEEE 802.3az EEE (Energy Efficient Ethernet)	Displays whether to enable IEEE 802.3az Energy Efficient Ethernet.
Enable Live Keypad	If enabled, phone will automatically dial out and turn on hands-free mode when keypad or softkey is pressed.

Status Page Definitions

Account Page Definitions

Account x → General Settings	
Account Register	
Account Active	Indicates whether the account is active. The default setting is "No".
Account Name	The name associated with each account to be displayed on the LCD. (e.g., MyCompany)
SIP Server	The URL or IP address, and port of the SIP server. This is provided by your VoIP service provider (e.g., sip.mycompany.com, or IP address)
Secondary SIP Server	The URL or IP address, and port of the SIP server. This will be used when the primary SIP server fails
Tertiary SIP Server	The URL or IP address, and port of the SIP server. This will be used when the primary and secondary SIP server fail.
Outbound Proxy	IP address or Domain name of the Primary Outbound Proxy, Media Gateway, or Session Border Controller. It's used by the phone for Firewall or NAT penetration in different network environments. If a symmetric NAT is detected, STUN will not work and ONLY an Outbound Proxy can provide a solution.
Secondary Outbound Proxy	IP address or Domain name of the Secondary Outbound Proxy which will be used when the primary proxy cannot be connected.
SIP User ID	User account information, provided by your VoIP service provider.

SIP Authentication ID	SIP service subscriber's Authenticate ID used for authentication. It can be identical to or different from the SIP User ID.
SIP Authentication Password	The account password required for the phone to authenticate with the SIP server before the account can be registered. After it is saved, this will appear as hidden for security purpose.
Name	The SIP server subscriber's name (optional) that will be used for Caller ID display (e.g., John Doe).
Tel URI	If the phone has an assigned PSTN telephone number, this field should be set to "user=phone". A "user=phone" parameter will be attached to the Request-URI and "To" header in the SIP request to indicate the E.164 number. If set to "Enable", "tel:" will be used instead of "sip:" in the SIP request.
Voice Mail Access Number	Allows users to access voice messages by pressing the MESSAGE button on the phone. This value is usually the VM portal access number.
Monitored Voicemail Access Number	Allows users to access the voice messages of monitored extension. This value is used together with the voicemail programmable keys.
BLF Server	Configures the BLF server (optional) used for SUBSCRIBE requests.
Picture	Configures picture for the account. It will be sent to the caller/callee for the call.
Account Display	When set to "Username", the LCD will display the Username if it is not empty and when set to "User ID", the LCD will display the User ID if it is not empty.
Network Settings	
DNS Mode	<p>This parameter controls how the Search Appliance looks up IP addresses for hostnames. There are four modes: A Record, SRV, NATPTR/SRV, Use Configured IP. The default setting is "A Record".</p> <p>If the user wishes to locate the server by DNS SRV, the user may select "SRV" or "NATPTR/SRV".</p> <p>If "Use Configured IP" is selected, please fill in the three fields below:</p> <ul style="list-style-type: none"> ● Primary IP ● Backup IP 1 ● Backup IP 2 <p>If SIP server is configured as domain name, the phone will not send DNS query, but use "Primary IP" or "Backup IP x" to send a SIP message if at least one of them are not empty.</p> <p>The Phone will try to use "Primary IP" first. After 3 tries without any response, it will switch to "Backup IP x", and then it will switch back to "Primary IP" after 3 re-tries.</p> <p>If the SIP server already has an IP address, the phone will use it directly even if "User Configured IP" is selected.</p>
Max Number Of Sip Request Retries	Sets the maximum number of retries for the device to send requests to the server. In DNS SRV configuration, if the destination address does not respond, all request messages are resent to the same address according to the configured retry times. Valid range: 1-10.
DNS SRV Failover Mode	<p>Configures the preferred IP mode for DNS SRV. If set to "default", the first IP from the query result will be applied. If set to "Saved one until DNS TTL", previous IP will be applied before DNS timeout is reached. If set to "Saved one until no response", previous IP will be applied even after DNS timeout until it cannot respond.</p> <ul style="list-style-type: none"> ● Default

	<p>If the option is set with “default”, it will again try to send register messages to one IP at a time, and the process repeats.</p> <ul style="list-style-type: none"> ● Saved one until DNS TTL <p>If the option is set with “Saved one until DNS TTL”, it will send register messages to the previously registered IP first. If no response, it will try to send one at a time for each IP. This behavior lasts if DNS TTL (time-to-live) is up.</p> <ul style="list-style-type: none"> ● Saved one until no responses <p>If the option is set with “Saved one until no responses”, it will send register messages to the previously registered IP first, but this behavior will persist until the registered server does not respond.</p> <ul style="list-style-type: none"> ● Failback follows failback expiration timer <p>If "Failback follows failback expiration timer" is selected, the device will send all SIP messages to the current failover SIP server or Outbound Proxy until the failback timer expires.</p>
Failback Expiration (m)	Specifies the duration (in minutes) since failover to the current SIP server or Outbound Proxy before making failback attempts to the primary SIP server or Outbound Proxy.
Register Before DNS SRV Failover	Indicates whether a REGISTER request will be initiated when a server failover occurred under DNS SRV mode. Default setting is No.
Primary IP	Configures the primary IP address where the phone sends DNS query to when “Use Configured IP” is selected for DNS mode.
Backup IP 1	Configures the backup IP 1 address where the phone sends DNS query to when “Use Configured IP” is selected for DNS mode.
Backup IP 2	Configures the backup IP 2 address where the phone sends DNS query to when “Use Configured IP” is selected for DNS mode.
NAT Traversal	Configures whether NAT traversal mechanism is activated. Please refer to user manual for more details. If set to “STUN” and STUN server is configured, the phone will route according to the STUN server. If NAT type is Full Cone, Restricted Cone or Port-Restricted Cone, the phone will try to use public IP addresses and port number in all the SIP&SDP messages. The phone will send empty SDP packet to the SIP server periodically to keep the NAT port open if it is configured to be “Keep-alive”. Configure this to be “No” if an outbound proxy is used. “STUN” cannot be used if the detected NAT is symmetric NAT. Set this to “VPN” if OpenVPN is used.
Support Rport (RFC 3581)	Configures to use symmetric response routing. If it is used, the "rport" field will be added to the Via header field in the SIP Request, and the information will be extracted from the SIP 200OK Response for SIP Register to rewrite the SIP Contact information and apply it in subsequent SIP Requests. Enabled by Default
Proxy-Require	A SIP Extension to notify the SIP server that the phone is behind a NAT/Firewall.
Use SBC	Configures whether a SBC server is used. Note: If enabled, make sure an outbound proxy is set up.
Account x → SIP Settings	
Basic Settings	

SIP Registration	Selects whether the phone will send SIP Register messages to the proxy/server. The default setting is “Enabled”.
UNREGISTER on Reboot	<p>Allows the SIP user’s registration information to be cleared when the phone reboots. The SIP REGISTER message will contain “Expires: 0” to unbind the connection. Three options are available: The default setting is “No”.</p> <ul style="list-style-type: none"> • If set to “No”, the phone will not unregister the SIP user’s registration information before new registration. • If set to “All”, the SIP user’s registration information will be cleared when the phone reboots. The SIP Contact header will contain “*” to notify the server to unbind the connection. • If set to “Instance”, the SIP user will be unregistered on current phone only.
REGISTER Expiration	<p>Specifies the frequency (in minutes) in which the phone refreshes its registration with the specified registrar.</p> <p>The maximum value is 64800 minutes (about 45 days). The default value is 60 minutes.</p>
SUBSCRIBE Expiration	<p>Specifies the frequency (in minutes) in which the phone refreshes its subscription with the specified registrar.</p> <p>The maximum value is 64800 minutes (about 45 days). The default value is 60 minutes.</p>
Re-Register before Expiration	<p>Specifies the time frequency (in seconds) that the phone sends re-registration request before the Register Expiration. The default value is 0.</p>
Registration Retry Wait Time	<p>Specifies the interval to retry registration if the process failed. Valid range is 1 to 3600. Default is 20.</p>
SIP SUBSCRIBE Retry Wait Time	<p>Configures the time interval to retry sending SIP SUBSCRIBE request if receive error response. Valid range is 1 to 3600. Default is 20.</p>
Add Auth Header on Initial REGISTER	<p>If enabled, the phone will add Authorization header in initial REGISTER request.</p>
Enable OPTIONS Keep-Alive	<p>Enable OPTIONS Keep Alive to check SIP Server.</p> <p>Default is “No”.</p>
OPTIONS Keep-Alive Interval	<p>Time interval for OPTIONS Keep Alive feature in seconds.</p> <p>Default is “30” seconds.</p>
OPTIONS Keep Alive Max Tries	<p>Configures the maximum number of times the phone will try to send OPTIONS message consistently to server without receiving a response. If set to "3", the phone will send OPTIONS message 3 times. If no response from the server, the phone will re-register.</p>
Enable TCP Keep-Alive	<p>Configures whether to enable Keep-Alive for TCP connection. Default is Yes.</p>
Subscribe for MWI	<p>When set to “Yes”, a SUBSCRIBE for Message Waiting Indication will be sent periodically. The phone supports synchronized and non-synchronized MWI. The default setting is “No”.</p>
Subscribe for Registration	<p>When set to “Yes”, a SUBSCRIBE for Registration will be sent out periodically. The default setting is “No”.</p>
Use Privacy Header	<p>Controls whether the Privacy header will present in the SIP INVITE message or not, whether the header contains the caller info.</p> <ul style="list-style-type: none"> • Default: The Privacy Header will show in INVITE only when “Huawei IMS” special feature is on.

	<ul style="list-style-type: none"> ● Yes: The Privacy Header will always show in INVITE. ● No: The Privacy Header will not show in INVITE. <p>The default setting is “default”.</p>
Use P-Preferred-Identity Header	<p>Controls whether the P-Preferred-Identity Header will present in the SIP INVITE message.</p> <ul style="list-style-type: none"> ● Default: The P-Preferred-Identity Header will show in INVITE unless “Huawei IMS” special feature is on. ● Yes: The P-Preferred-Identity Header will always show in INVITE. ● No: The P-Preferred-Identity Header will not show in INVITE. <p>The default setting is “default”.</p>
Use X-Grandstream-PBX Header	<p>Enables / disables the use of X-Grandstream-PBX header in SIP request. When disabled, the SIP message sent from the phone will not include the selected header. The default setting is "Yes".</p>
Use P-Access-Network-Info Header	<p>Enables / disables the use of P-Access-Network-Info header in SIP request. When disabled, the SIP message sent from the phone will not include the selected header. The default setting is "Yes".</p>
Use P-Emergency-Info Header	<p>Enables / disables the use of P-Emergency-Info header in SIP request. When disabled, the SIP message sent from the phone will not include the selected header. The default setting is "Yes".</p>
Use P-Asserted-Identity Header	<p>Configure whether the "P-Asserted-Identity Header" is present in the SIP INVITE message. The default setting is "No".</p>
Use P-Early-Media Header	<p>Configure whether the "Use P-Early-Media Header " is present in the SIP INVITE message. If this setting is configured as "Yes", the phone will send a SIP INVITE request with the header "P-Early-Media : supported".</p> <p>The default setting is "No".</p>
Use X-switch-info Header	<p>Configures whether "X-switch-info Header" is included in SIP REGISTER request.</p>
Use MAC Header	<ul style="list-style-type: none"> ● If Yes for REGISTER only, the sip message for register or unregister will contains MAC address in the header, and all the outgoing SIP messages except REGISTER message will attach the MAC address to the User-Agent header. ● If Yes to all SIP, the sip message for register or unregister will contains MAC address in the header, and all the outgoing SIP message including REGISTER will attach the MAC address to the User-Agent header. ● If No, neither will the MAC header be included in the register or unregister message nor the MAC address be attached to the User-Agent header for any outgoing SIP message. <p>The default setting is "No".</p>
Add MAC in User-Agent	<ul style="list-style-type: none"> ● If Yes except REGISTER, all outgoing SIP messages will include the phone’s MAC address in the User-Agent header, except for REGISTER and UNREGISTER. ● If Yes to All SIP, all outgoing SIP messages will include the phone’s MAC address in the User-Agent header. ● If No, the phone’s MAC address will not be included in the User-Agent header in any outgoing SIP messages. <p>The default setting is "No".</p>
SIP Transport	<p>Determines the network protocol used for the SIP transport. Users can choose from TCP, UDP and TLS. The default setting is “UDP”.</p>

SIP Listening Mode	<p>Determines whether or not to listen to multiple SIP protocols.</p> <ul style="list-style-type: none"> ● Transport Only: will listen to configured transport protocol only. ● Dual: will listen to TCP when UDP is selected. ● Dual (Secured): will listen to TLS/TCP when UDP is selected. If TCP or TLS/TCP is selected, UDP will be listened to ● Dual (BLF Enforced): will try to enforce BLF subscriptions to use TCP protocol by adding ‘transport=tcp’ to the Contact header. <p>The default setting is “Transport Only”.</p>
Local SIP Port	<p>Defines the local SIP port used to listen and transmit. The default value is 5060 for Account 1, 5062 for Account 2, 5064 for Account 3, 5066 for Account 4, 5068 for Account 5, 5070 for Account 6. The valid range is from 1024 to 65400.</p>
SIP URI Scheme When Using TLS	<p>Specifies if “sip” or “sips” will be used when TLS/TCP is selected for SIP Transport. The default setting is “sips”.</p>
Use Actual Ephemeral Port in Contact with TCP/TLS	<p>This option is used to control the port information in the Via header and Contact header. If set to No, these port numbers will use the permanent listening port on the phone. Otherwise, they will use the ephemeral port for the connection</p> <p>The default setting is “No”.</p>
Support SIP Instance ID	<p>Defines whether SIP Instance ID is supported or not. Default setting is “Yes”.</p>
SIP T1 Timeout	<p>SIP T1 Timeout is an estimate of the round-trip time of transactions between a client and server. If no response is received the timeout is increased, and request re-transmit retries would continue until a maximum amount of time define by T2. The default setting is 0.5 seconds.</p>
SIP T2 Timeout	<p>SIP T2 Timeout is the maximum retransmit time of any SIP request messages (excluding the INVITE message). The re-transmitting and doubling of T1 continues until it reaches the T2 value. Default is 4 seconds.</p>
Outbound Proxy Mode	<p>The Outbound proxy mode is placed in the route header when sending SIP messages, or they can be always sent to outbound proxy.</p> <ul style="list-style-type: none"> ● In route ● Not in route ● Always send to <p>Default is “in route”.</p>
Enable 100rel	<p>The use of the PRACK (Provisional Acknowledgment) method enables reliability to SIP provisional responses (1xx series). This is very important to support PSTN internetworking. To invoke a reliable provisional response, the 100rel tag is appended to the value of the required header of the initial signaling messages. The default setting is “No”</p>
Use Route Set In NOTIFY (Follow RFC 6665)	<p>Configures whether to use route set in NOTIFY (follow RFC 6665). If enabled, the Request URI of the refresh subscription will use the URI in the received NOTIFY Contact (RFC 6665); otherwise, the URI in the previously subscribed 200 OK Contact will be used. The default setting is "Yes".</p>
Session Timer	
Enable Session Timer	<p>This option is used to enable or disable session timer on the phone side when server side can provide both session timer UPDATE or session audit UPDATE.</p> <p>The default setting is “No”.</p>
Session Expiration	<p>The SIP Session Timer extension (in seconds) that enables SIP sessions to be periodically “refreshed” via a SIP request (UPDATE, or re-INVITE). If there is no</p>

	<p>refresh via an UPDATE or re-INVITE message, the session will be terminated once the session interval expires. Session Expiration is the time (in seconds) where the session is considered timed out, provided no successful session refresh transaction occurs beforehand.</p> <p>The default setting is 180. The valid range is from 90 to 64800.</p>
Min-SE	The minimum session expiration (in seconds). The default value is 90 seconds. The valid range is from 90 to 64800.
Caller Request Timer	If set to “Yes” and the remote party supports session timers, the phone will use a session timer when it makes outbound calls. The default setting is "No".
Callee Request Timer	If set to “Yes” and the remote party supports session timers, the phone will use a session timer when it receives inbound calls. The default session is "No".
Force Timer	If Force Timer is set to “Yes”, the phone will use the session timer even if the remote party does not support this feature. If Force Timer is set to “No”, the phone will enable the session timer only when the remote party supports this feature. To turn off the session timer, select “No”. The default setting is "No".
UAC Specify Refresher	As a Caller, select UAC to use the phone as the refresher; or select UAS to use the Callee or proxy server as the refresher. The default setting is "UAC".
UAS Specify Refresher	As a Callee, select UAC to use caller or proxy server as the refresher; or select UAS to use the phone as the refresher. The default setting is "UAC".
Force INVITE	The Session Timer can be refreshed using the INVITE method or the UPDATE method. Select “Yes” to use the INVITE method to refresh the session timer. The default setting is "No".
Account x → Codec Settings	
Audio	
Preferred Vocoder (Choice 1 – 8)	Multiple vocoder types are supported on the phone, the vocoders in the list is a higher preference. Users can configure vocoders in a preference list that is included with the same preference order in SDP message.
Codec Negotiation Priority	Configures the phone to use which codec sequence to negotiate as the callee. When set to “Caller”, the phone negotiates by SDP codec sequence from received SIP Invite. When set to “Callee”, the phone negotiates by audio codec sequence on the phone. The default setting is “Callee”.
Use First Matching Vocoder in 200OK SDP	When it is set to “Yes”, the device will use the first matching vocoder in the received 200OK SDP as the codec. The default setting is “No”.
Hide Vocoder	When option Hide Vocoder is set as Yes, the coded will be hidden from call screen as bellow The default setting is “No”.
Configures to enable or disable multiple m lines in SDP	If enabled, the phone always responds one m line in SDP regardless multiple m lines are offered.
iLBC Frame Size	This option determines the iLBC packet frame size. Users can choose from 20ms and 30ms. The default setting is “30ms”.

iLBC Payload Type	This option is used to specify iLBC payload type. Valid range is 96 to 127. The default setting is “97”.
G.726-32 Packing Mode	Selects “ITU” or “IETF” for G726-32 packing mode. The default setting is “ITU”.
OPUS Payload Type	Specifies OPUS payload type. Valid range is 96 to 127. Cannot be the same as iLBC or DTMF Payload Type. Default value is 123.
Send DTMF	This parameter specifies the mechanism to transmit DTMF digits. There are 3 supported modes: <ul style="list-style-type: none"> ● In audio: DTMF is combined in the audio signal (not very reliable with low-bit-rate codecs). ● RFC2833 sends DTMF with RTP packet. Users can check the RTP packet to see the DTMFs sent as well as the number pressed. ● SIP INFO uses SIP INFO to carry DTMF. Default setting is “RFC2833”.
DTMF Delay	Configures the delay between sending DTMF during MPK/VPK use (in milliseconds). Default is “250” ms.
DTMF Payload Type	Configures the payload type for DTMF using RFC2833. Cannot be the same as iLBC or OPUS payload type.
Silence Suppression	Controls the silence suppression/VAD feature of the audio codecs except for G.723 (pending) and G.729. If set to “Yes”, a small quantity of RTP packets containing comfort noise will be sent during the periods of silence. If set to “No”, this feature is disabled. Default setting is “No”
Jitter Buffer Type	Selects either Fixed or Adaptive for jitter buffer type, based on network conditions. The default setting is “Adaptive”.
Jitter Buffer Length	Selects jitter buffer length from 100ms to 800ms, based on network conditions. The default setting is “300ms”.
Voice Frames Per TX	Configures the number of voice frames transmitted per packet. When configuring this, it should be noted that the “ptime” value for the SDP will change with different configurations here. This value is related to the codec used and the actual frames transmitted during the in-payload call. For end users, it is recommended to use the default setting, as incorrect settings may influence the audio quality. The default setting is 2.
G723 Rate	This option determines the encoding rate for G723 codec. Users can choose from 6.3kbps encoding rate and 5.3kbps encoding rate. The default setting is “5.3kbps encoding rate”.
RTP Settings	
SRTP Mode	Enable SRTP mode based on your selection from the drop-down menu. <ul style="list-style-type: none"> ● No ● Enabled But Not forced ● Enabled and Forced ● Optional The default setting is “No”.

SRTP Key Length	<p>Allows users to specify the length of the SRTP calls. Available options are:</p> <ul style="list-style-type: none"> • AES 128&256 bit • AES 128 bit • AES 256 bit <p>Default setting is: AES 128&256 bit</p>
Crypto Life Time	<p>Enable or disable the crypto life time when using SRTP. If users set to disable this option, phone does not add the crypto life time to SRTP header.</p> <p>The default setting is “Yes”.</p>
Enable RTCP	<p>Enables user to select to use RTCP, RTCP-XR, or disable the feature.</p> <p>Set to RTCP-XR by Default.</p>
RTCP Mode	<p>Configure RTCP port negotiation rules. If set to "default", it will use the traditional RTCP port, which is "RTP port+1".</p> <p>If set to "Negotiate RTCP Port", it will use attribute RTCP to negotiate.</p> <p>Set to "Default".</p>
Collector Address Selection	<p>When set to 'Manual' mode, the VQ RTCP-XR Collector Name/Address/Port will serve as the destination for publishing VQ reports. In 'Auto' mode, the phone will automatically use the same address as the SIP REGISTER to publish VQ reports.</p> <p>Set to "Manual" By Default.</p>
VQ RTCP-XR Collector Name	<p>Configures the host name of the central report collector that accepts voice quality reports contained in SIP PUBLISH messages.</p>
VQ RTCP-XR Collector Address	<p>Configures the IP address of the central report collector that accepts voice quality reports contained in SIP PUBLISH messages.</p>
VQ RTCP-XR Collector Port	<p>Configure the port of the central report collector that accepts voice quality reports contained in SIP PUBLISH messages. Default is “5060”.</p>
Symmetric RTP	<p>Defines whether symmetric RTP is supported or not.</p> <p>Default setting is “No”.</p>
Account x → Call Settings	
General	
Key As Send	<p>Defines the timeout (in seconds) for no key entry. If no key is pressed after the timeout, the digits will be sent out. The default value is 4 seconds.</p> <p>The default setting is “Pound (#)”.</p>
No Key Entry Timeout	<p>Configures the timeout (in seconds) for no key entry. If no key is pressed after the timeout, the collected digits will be sent out. The default setting is 4.</p>
Send Anonymous	<p>If set to “Yes”, the “From” header in outgoing INVITE messages will be set to anonymous, blocking the Caller ID to be displayed.</p> <p>Default is “No”.</p>
Anonymous Call Rejection	<p>If set to “Yes”, anonymous calls will be rejected.</p> <p>The default setting is “No”.</p>
Enable Call Waiting	<p>Enables / disables the call waiting feature for the current account. When set to “Default”, global call feature setting will be used.</p> <p>Default value is “Default”.</p>

RFC2543 Hold	<p>Allows users to toggle between RFC2543 hold and RFC3261 hold. RFC2543 hold (0.0.0.0) allows user to disable the hold music sent to the other side. RFC3261 (a line) will play the hold music to the other side.</p> <p>The default setting is “No”.</p>
Ring Timeout	<p>Defines the timeout (in seconds) for the rings on no answer. The default setting is 60. The valid range is from 10 to 300.</p>
Ringback Tone at No Early Media	<p>Ensures that ringback tone is played to the caller even if no early media RTP packets are received. P-Early-Media Header support needs to be enabled for this feature.</p> <p>When both options are enabled, the phone will play ringback tone when the RTP packets of early media are blocked from the intermediate server. The phone also receives a "P-Early-Media" header with value "inactive","recvonly" or "gated" in 180/183 response.</p>
Call Log	<p>Configures Call Log setting on the phone.</p> <ul style="list-style-type: none"> ● Log All Calls ● Log incoming/Outgoing Only (missed calls NOT recorded) ● Disable Call Log <p>The default setting is “Log All Calls”.</p>
Auto Answer	
Auto Answer	<p>If set to “Yes”, the phone will automatically turn on the speaker phone to answer incoming calls after a short reminding beep.</p> <p>Default setting is “No”.</p>
Auto answer numbers	<p>The function allows users to have the phone configured with a pre-defined list of numbers that will perform auto answer.</p> <p>For “Auto Answer Numbers”, it accepts:</p> <p>Digits: 1,2,3,4,5,6,7,8,9; x – any digit from 0-9; xx – any two digits from 0-9; [1-5] – any digit from 1 to 5; 5. +: it matches the previous character as many times as needed like 6. regular expression.</p> <p>Note: Auto Answer Numbers can be split with ";", for example: 1x;2xxx;3x+</p>
Intercom	
Play warning tone for Auto Answer Intercom	<p>When enabled, the phone will play warning tone when auto answer Intercom.</p> <p>The default value is “Yes”.</p>
Custom Alert-Info for Auto Answer	<p>Allows to customize Alert-Info header for auto answer. The phone will auto answer only if matching content of the custom Alert-info header.</p>
Allow Auto Answer by Call-Info/Alert-Info	<p>Allows the phone to automatically turn on the speaker phone to answer incoming calls after a short reminding beep when enabled, based on the SIP Call-Info/Alert-Info header sent from the server/proxy.</p> <p>Default is “Yes”.</p>

<p>Allow Barging by Call-Info/Alert-Info</p>	<p>When enabled, the phone will automatically put the current call on hold and answer the incoming call based on the SIP Call-Info/Alert-Info header sent from the server/proxy. However, if the current call was answered based on the SIP Call-Info/Alert-Info header, then all other incoming calls with SIP Call-Info/Alert-Info headers will be rejected automatically. Default setting is “No”.</p>
<p>Mute on answer Intercom call</p>	<p>When enabled, the phone will mute the incoming intercom call. The default value is “No”.</p>
<p>Transfer</p>	
<p>Transfer on Conference Hang-up</p>	<p>If set to “Yes”, when the phone hangs up as the conference initiator, the conference call will be transferred to the other parties so that other parties will remain in the conference call. The default setting is “No”.</p>
<p>Enable Recovery on Blind Transfer</p>	<p>Disables recovery to the call to the transferee on failing blind transfer to the target. The default setting is “Yes”.</p> <p>Notes:</p> <ol style="list-style-type: none"> 1. This feature only applies to blind transfer. 2. This feature depends on how server handles transfer. If there is any NOTIFY from server, this feature won't take effect. If server responds 4xx, phone should try to recover regardless of this option. 3. During blind transfer, after transferor received 200/202 for REFER, but there is no NOTIFY from server after 7 seconds, transferor will decide to recover the call with transferee or not depending on the options. This is the only case that this option will be applied.
<p>Blind Transfer Wait Timeout</p>	<p>Defines the timeout (in seconds) for waiting SIP frag response in blind transfer. Valid range is 30 to 300. Default setting is “30”.</p>
<p>Refer-To Use Target Contact</p>	<p>If set to “Yes”, the “Refer-To” header uses the transferred target’s Contact header information for attended transfer. The default setting is “No”.</p>
<p>Hide Dialing Password</p>	<p>Allows users to hide the password when the dialing number matches the configured prefix.</p> <ul style="list-style-type: none"> ● Prefix for Dialing Password ● Password Length
<p>Early Dial</p>	<p>Selects whether to enable early dial. If it’s set to “Yes”, the SIP proxy must support 484 responses. Early Dial means that the phone sends for each pressed digit a SIP INVITE message to SIP server. SIP server considers its extensions and, if no match happened yet, it sends back a “484 Address Incomplete” message. Otherwise, it executes the action. The default setting is “No”.</p>
<p>Transfer to VM feature code</p>	<p>Configures the transfer to voicemail feature code which will be used as an extension prefix and called into the server to complete the transfer to voicemail event. There are two methods to use the Transfer to VM feature:</p> <p>Using the Transfer Softkey:</p> <ol style="list-style-type: none"> 1. During the call, press the transfer softkey and enter the target voicemail number. 2. Long press the Blind Transfer softkey or press the voicemail hardkey. <p>Using the VM Hardkey:</p>

	<ol style="list-style-type: none"> 1. While in call, press the VM hardkey to access the voicemail transfer screen. 2. Enter the target voicemail. 3. Press the “TRNF>VM” softkey or press the voicemail hardkey.
Call Forward	
Enable Forward All	If set to "Yes", all calls will be forwarded to the number specified below.
All To	Specifies the number to be forwarded to when enabled Forward all.
Enable Busy Forward	If set to "Yes", call will be forwarded to the number specified below on busy.
Busy To	Specifies the number to be forwarded to for Call Forward On Busy.
Enable No Answer Forward	Specifies the number to be forwarded to for Call Forward On Busy.
No Answer To	Specifies the number to be forwarded to for Call Forward On Busy.
No Answer Timeout (s)	Specifies the number to be forwarded to for Call Forward On Busy. The default value is 12 seconds. The valid range is 1 to 120.
Dial Plan	
Dial Plan Prefix	Configures a prefix added to all numbers when making outbound calls.
Bypass Dial Plan	<p>Enable/Disable the dial plan bypass while dialing through:</p> <ul style="list-style-type: none"> • Contact • Call History Incoming Call • Call History Outgoing Call • Dialing Page • MPK • API <p>The default setting is “MPK”.</p>
Dial Plan	<p>A dial plan establishes the expected number and pattern of digits for a telephone number. This parameter configures the allowed dial plan for the phone. Default setting is “{ x+ +x+ *x+ *xx*x+ }”.</p> <p>Dial Plan Rules:</p> <ol style="list-style-type: none"> 1. Accepted Digits: 1,2,3,4,5,6,7,8,9,0, *, #, A,a,B,b,C,c,D,d; 2. Grammar: x – any digit from 0-9; <ul style="list-style-type: none"> • Grammar: x – any digit from 0-9; • Grammar: X – any character from 0-9, a-z, A-Z. • xx+ – at least 2-digit numbers • xx – only 2-digit numbers • ^ – exclude • [3-5] – any digit of 3, 4, or 5 • [147] – any digit of 1, 4, or 7 • <2=011> – replace digit 2 with 011 when dialing • – the OR operand • , – second dial tone. For example: {0,x+} will play second dial tone after dialing 0 and all digits will be sent including 0 • {X123} — match Z123, e123, 5123, ... • Flag T when adding a “T” at the end of the dial plan, the phone will wait for 3 seconds before dialing out. This gives users more flexibility on their dial plan setup. E.g. with dial plan 1XXT, phone will wait for 3 seconds to let user dial more than just 3 digits if needed. Originally the phone will dial out immediately after dialing the third digit.

	<ul style="list-style-type: none"> ● Back slash “\” — can be used to escape specific letters. E.g. if { park+60 } dial plan is configured, park+60 should be able to pass dial plan check. This also can be used to escape Mark and User-unreserved characters. <p>Mark = “-“ / “_” / “.” / “!” / “~” / “*” / “” / “(“ / “)”</p> <p>User-unreserved = “&” / “=” / “+” / “\$” / “;” / “;” / “?” / “/”</p> <ul style="list-style-type: none"> ● Example 1: {[369]11 1617xxxxxxx} <p>Allow 311, 611, and 911 or any 11 digit numbers with leading digits 1617;</p> <ul style="list-style-type: none"> ● Example 2: {^1900x+ <=1617>xxxxxxx} <p>Block any number of leading digits 1900 or add prefix 1617 for any dialed 7 digit numbers;</p> <ul style="list-style-type: none"> ● Example 3: {1xxx[2-9]xxxxxx <2=011>x+} <p>Allows any number with leading digit 1 followed by a 3-digit number, followed by any number between 2 and 9, followed by any 7-digit number OR Allows any length of numbers with leading digit 2, replacing the 2 with 011 when dialed.</p> <ul style="list-style-type: none"> ● Example 4: If we set the dial plan with { *123 }, it should allow input *123 to pass dial plan check. ● Example 5: If we set the dial plan with { \$123 }, it should allow input \$123 to pass dial plan check. ● Example 6: If we set the dial plan with { 12_3 }, it should allow input 12_3 to pass dial plan check. <p>Example of a simple dial plan used in a Home/Office in the US: { ^1900x. <=1617>[2-9]xxxxxx 1[2-9]xx[2-9]xxxxxx 011[2-9]x. [3469]11 }</p> <p>Explanation of example rule (reading from left to right):</p> <ul style="list-style-type: none"> ● ^1900x. – prevents dialing any number started with 1900; ● <=1617>[2-9]xxxxxx – allows dialing to local area code (617) numbers by dialing 7 numbers and 1617 area code will be added automatically; ● 1[2-9]xx[2-9]xxxxxx - allows dialing to any US/Canada Number with 11 digits length; ● 011[2-9]x – allows international calls starting with 011; ● [3469]11 – allows dialing special and emergency numbers 311, 411, 611 and 911. <p>Note: In some cases, where the user wishes to dial strings such as *123 to activate voice mail or other applications provided by their service provider, the * should be predefined inside the dial plan feature.</p> <p>An example dial plan will be: { *x+ } which allows the user to dial * followed by any length of numbers.</p>
<p>Call Display</p>	
<p>Caller ID Display</p>	<p>Determines from where to locate caller ID to display or not on the phone</p> <ul style="list-style-type: none"> ● Auto: The phone will look for the caller ID in the order of P-Asserted Identity Header, Remote-Party-ID Header and From Header in the incoming SIP INVITE. ● Disabled: All incoming calls are displayed with “Unavailable”. ● From Header: the phone will display the caller ID based on the From Header in the incoming SIP INVITE. <p>The default setting is “From Header”.</p>
<p>Callee ID Display</p>	<p>Determines from where to locate callee ID to display or not on the phone.</p> <ul style="list-style-type: none"> ● Auto: The phone will update the callee ID in the order of P-Asserted Identity Header, Remote-Party-ID Header and To Header in the 180 Ringing ● Disabled: Callee ID will be displayed as “Unavailable”. ● To Header: Callee ID will not be updated and displayed as To Header. <p>The default setting is “Auto”.</p>
<p>Ringtone</p>	

Account Ring Tone	<p>Allows users to configure the ringtone for the account. Users can choose from different ringtones from the dropdown menu.</p> <p>Note: User can also choose silent ring tone.</p>
Ignore Alert-Info header	<p>This option is used to configure default ringtone. If set to “Yes”, configured default ringtone will be played. The default setting is “No”.</p>
Match Incoming Caller ID	<p>Specifies matching rules with number, pattern, or Alert Info text (up to 10 matching rules). When the incoming caller ID or Alert Info matches the rule, the phone will ring with selected distinctive ringtone. Matching rules:</p> <ul style="list-style-type: none"> • Specific caller ID number. For example, 8321123. • A defined pattern with certain length using x and + to specify, where x could be any digit from 0 to 9. Samples: xx+ : at least 2-digit number. xx : only 2-digit number. [345]xx: 3-digit number with the leading digit of 3, 4 or 5. [6-9]xx: 3-digit number with the leading digit from 6 to 9. <ul style="list-style-type: none"> • Alert Info text <p>Users could configure the matching rule as certain text (e.g., priority) and select the custom ring tone mapped to it. The custom ring tone will be used if the phone receives SIP INVITE with Alert-Info header in the following format: <i>Alert-Info:</i> <code><http://127.0.0.1>; info=priority</code></p> <p>Selects the distinctive ring tone for the matching rule. When the incoming caller ID or Alert Info matches one of the 10 rules, the phone will ring with the associated ringtone.</p> <ul style="list-style-type: none"> • Remote Ringtone via Alert Info <p>The remote ringtone feature enables the use of a ringtone stream via a remote URL. The functionality of this feature works as follows: the following audio file named test.wav is uploaded onto an HTTP server and the remote URL is "http://192.168.5.165:8080/test.wav;info=ring3", the IP phone then attempts to use the provided URL first to play the ringtone. If the URL is not functional for some reason, it will then use the info=ring3 parameter, as the default ringtone.</p>
Account x → Advanced Settings	
Security Settings	
Check Domain Certificates	<p>Choose whether the domain certificates will be checked or not when TLS/TCP is used for SIP Transport. The default setting is “No”.</p>
Trusted Domain Name List	<p>This option allows you to populate a list of trusted domain names used for TLS certificate verification. When obtaining certificates, the system verifies if the domain name matches any entry in the trusted domain list. By default, the remote proxy domain name and SIP server domain name are trusted. You can enter alphanumeric characters, hyphens, periods, and asterisks in the list. Wildcard domain names like "*.grandstream.com" are supported, as well as any domain ending with ".grandstream.com" will be trusted.</p> <p>You can submit up to 10 trusted domain names for TLS certificate verification.</p>
Validate Certificate Chain	<p>Validate certification chain when TCP/TLS is configured.</p> <p>Default setting is “No”.</p>
Validate Incoming Messages	<p>Choose whether the incoming messages will be validated or not.</p> <p>The default setting is “No”.</p>
Omit charset=UTF-8 in MESSAGE	<p>Omit charset=UTF-8 in MESSAGE content-type.</p> <p>The default setting is “Disabled”.</p>

Allow Unsolicited REFER	<p>Allow Unsolicited REFER to accomplish an outgoing call.</p> <ul style="list-style-type: none"> ● Disabled ● Enabled ● Enabled/Force Auth <p>The default setting is “Disabled”.</p>
Accept Incoming SIP from Proxy Only	<p>When set to “Yes”, the SIP address of the Request URL in the incoming SIP message will be checked. If it doesn’t match the SIP server address of the account, the call will be rejected.</p> <p>The default setting is “No”.</p>
Check SIP User ID for Incoming INVITE	<p>If set to “Yes”, SIP User ID will be checked in the Request URI of the incoming INVITE. If it doesn’t match the phone’s SIP User ID, the call will be rejected.</p> <p>The default setting is “No”.</p>
Allow SIP Reset	<p>This is used to perform a factory reset through SIP NOTIFY. When the phone receives the NOTIFY with Event: reset, the phone should perform a factory reset after the authentication. The default setting is “No”.</p>
Authenticate Incoming INVITE	<p>If set to “Yes”, the phone will challenge the incoming INVITE for authentication with SIP 401 Unauthorized response</p> <p>Default setting is “No”.</p>
MOH	
On Hold Reminder Tone	<p>If set to “Enabled”, phone will play a reminder tone when it has a call on hold.</p> <p>The default setting is “Enabled”.</p>
Music On Hold URI	<p>Configures Music On Hold URI to call when a call is on hold. This feature must be supported on the server side.</p>
Advanced Features	
Special Feature	<p>Different soft switch vendors have special requirements. Therefore, users may need select special features to meet these requirements. Users can choose from Standard, Nortel MCS, Broadsoft, CBCOM, RNK, Sylanro, Huawei IMS, PhonePower and UCM Call center depending on the server type. The default setting is “Standard”.</p>
Feature Key Synchronization	<p>This feature is used for Broadsoft call feature synchronization. When it’s enabled, DND, Call Forward features and Call Center Agent status can be synchronized between Broadsoft server and phone. Default is “Disabled”.</p>
Conference URI	<p>Configures Conference URI for N-way conference (Broadsoft Standard).</p>
Broadsoft Call Center	<p>When set to “Yes”, a Softkey “BSCCenter” is displayed on LCD. User can access different Broadsoft Call Center agent features via this Softkey.</p> <p>Please note that “Feature Key Synchronization” will be enabled regardless of this setting. Default setting is “Disabled”.</p> <p>Note: To activate this feature, users need to change the special feature to Broadsoft and setup the Broadsoft Call Center to take effect.</p>
Hoteling Event	<p>Broadsoft Hoteling event feature. Default setting is “Disabled”. With “Hoteling Event” enabled, user can access the Hoteling feature option by pressing the “BSCCenter” softkey.</p> <p>Note: To activate this feature, users need to change the special feature to Broadsoft and setup the Broadsoft Call Center to take effect.</p>

Call Center Status	<p>When set to “Yes”, the phone will send SUBSCRIBE to the server to obtain call center status. The default setting is “Disabled”.</p> <p>Note: To activate this feature, users need to change the special feature to Broadsoft and setup the Broadsoft Call Center to take effect.</p>
Broadsoft Executive Assistant	<p>When enabled, Feature Key Synchronization will be enabled regardless of web settings.</p> <p>Note: To activate this feature, users need to change the special feature to Broadsoft and setup the Broadsoft Call Center to take effect.</p>
Broadsoft Call Park	<p>When enabled, it will send SUBSCRIBE to Broadsoft server to obtain Call Park notifications. The default setting is “Disabled”.</p> <p>Note: To activate this feature, users need to change the special feature to Broadsoft and setup the Broadsoft Call Center to take effect.</p>
BLF (Busy Lamp Field)	
Presence Eventlist URI	<p>Configures Presence Eventlist URI to monitor the extensions on Multi-Purpose Keys. If the server supports this feature, users need to configure a Presence Eventlist URI on the service side first (i.e., presence@myserver.com) with a list of extensions included. On the phone, in this “Presence Eventlist URI” field, fill in the URI without the domain (i.e., presence). To monitor the extensions in the list, under Web GUI→Settings→Programmable Keys page, please select “Presence Watcher” in the key mode, choose account, enter the value of each extension in the list.</p>
Eventlist BLF URI	<p>Configures the Eventlist BLF URI on the phone to monitor the extensions in the list with Multi-Purpose Key. If the server supports this feature, users need to configure an Eventlist BLF URI on the service side first (i.e., BLF1006@myserver.com) with a list of extensions included. On the phone, in this “Eventlist BLF URI” field, fill in the URI without the domain (i.e., BLF1006). To monitor the extensions in the list, under Web GUI→Settings→Programmable Keys page, please select “Eventlist BLF” in the key mode, choose account, enter the value of each extension in the list.</p>
Auto Provision Eventlist BLFs	<p>When option is enabled, empty multi-purpose keys will be automatically provisioned to the monitored extensions in the “Eventlist BLF” or “Presence Eventlist”.</p> <ul style="list-style-type: none"> ● Disabled ● BLF Eventlist ● Presence Eventlist <p>The default setting is “Disabled”.</p>
BLF Call-pickup	<p>Configures BLF Call-pickup method:</p> <ul style="list-style-type: none"> ● Auto: The phone will do either Prefix or barge in code for BLF pickup depend on which on is set. ● Force BLF Call-pickup by prefix: The phone will only use Prefix as BLF pickup method. ● Disabled: The phone will ignore both BLF pickup method, now the monitored VPK will only dial the extension if pressed. <p>The default setting is “Auto”.</p>
BLF Call-pickup Prefix	<p>Configures the prefix prepended to the BLF extension when the phone picks up a call with BLF key. The default setting is **.</p>
Call Pickup Barge-In Code	<p>Set feature access code of Call Pickup with Barge-In feature.</p>
Call Park Feature Code	<p>Configures the feature access code for parking current call to parking lot or another extension.</p>
Call Park Retrieve Feature Code	<p>Configures the feature access code for parking current call to parking lot or another extension</p>

PUBLISH for Presence	Enables presence feature on the phone. The default setting is “Disabled”.
SCA	
Line-Seize Timeout	For Shared Call Appearance, phone must send a SUBSCRIBE-request for the line-seize event package whenever a user attempt to take the shared line off hook. “Line Seize Timeout” is the line-seize event expiration timer. The default value is 15 seconds. The valid range is from 15 to 60.
Dial Plan	
Name	Enter the name for the configured rules.
Rule	Enter the rule settings (number pattern, prefix to add ...etc).
Type	Choose the type of the rule (pattern, block, dial now, prefix & second tone).
Account x → Hidden Number Plan	
Hidden Number Features	<p>Configure one of the following options for the hidden number features.</p> <ul style="list-style-type: none"> ● Disabled: No number hiding applied. ● Incoming Calls Only: Hides caller ID for received calls. ● Outgoing Calls Only: Masks the caller's number when making calls. ● Both Direction Calls: Applies number hiding to incoming and outgoing calls.
Hidden Number Plan List	<p>Configure the hidden number rules, matching their syntax rules from top to bottom as follows:</p> <ol style="list-style-type: none"> 1. Expression element(element)element (element)element element(element) (element) 2. Element Rules <ul style="list-style-type: none"> • x: any digit number from 0-9 • x+: substring with only digits (length>=1) • [-+.*,#;]: possible special symbols in number • (): the substring that needs to be hidden, there can be multiple hidden parts in a rule 3. Examples x+(xxxx)xxxx: 13705806547 -> 137****6547 xxx(x+)xxxx: 07113705806547 -> 071137****6547 071-x+(xxxx)xxxx: 071-13705806547 -> 071-137****6547 <p>Note: users can configure up to 6 hidden number plans.</p>
Hidden Number Plan Test	Allows to test the hidden rules of the current configuration by entering a number and checking the result.
Account x → Feature Codes	
Enable Local Call Features	<p>When enabled, Do Not Disturb, Call Forwarding and other call features can be used via the local feature codes on the phone. Otherwise, the provisioned feature codes from the server will be used. User configured feature codes will be used only if server provisioned feature codes are not provided. And once feature codes are configured, either via server provisioning or local setting, a Softkey named “Features” will show on the LCD screen.</p> <p>Note: If the device is registered with Broadsoft account, it doesn’t matter if local call features are enabled or disabled, once the Broadsoft account is set, special feature to</p>

	Broadsoft and Feature Key Synchronization is enabled, the call feature will be handled by Broadsoft server, not by the phone.
DND	
DND Call Feature On	Configures DND feature code to turn on DND.
DND Call Feature Off	Configures DND feature code to turn off DND.
Call Forward Always	
On	Configures Call Forward Always feature code to activate unconditional call forwarding.
Off	Configures Call Forward Always feature code to deactivate unconditional call forwarding.
Target	Configures the extension for the call to be forwarded to.
Call Forward Busy	
On	Configures Call Forward Busy feature code to activate busy call forwarding.
Off	Configures Call Forward Busy feature code to deactivate busy call forwarding.
Target	Configures the extension for the call to be forwarded to.
Call Forward No Answer	
On	Configures Call Forward No Answer feature code to activate no answer call forwarding.
Off	Configures Call Forward Busy feature code to deactivate busy call forwarding.
Target	Configures the extension for the call to be forwarded to.
Call Forward No Answer Timeout (s)	Configures the timeout (in seconds) before the call is forwarded when there is no answer. Valid range is 1 to 120. The default setting is 12 seconds.
Accounts → Account Swap	
Swap Account Settings	Allows users to swap the two accounts that they have configured. This will increase the flexibility of account management. Note: Make sure to press “Start” to complete the process.

Account Page Definitions

Phone Settings Page Definitions

Phone Settings → General Settings	
Basic Settings	
Local RTP Port	This parameter defines the local RTP port used to listen and transmit. It is the base RTP port for channel 0. When configured, channel 0 will use this port_value for RTP; channel 1 will use port_value+2 for RTP. Local RTP port ranges from 1024 to 65400 and must be even. Default value is 5004.

Local RTP Port Range	Gives users the ability to define the parameter of the local RTP port used to listen and transmit. This parameter defines the local RTP port from 48 to 10000. This range will be adjusted if local RTP port + local RTP port range is greater than 65486. Default setting is 200.
Use Random Port	When set to “Yes”, this parameter will force random generation of both the local SIP and RTP ports. This is usually necessary when multiple phones are behind the same full cone NAT. The default setting is “Yes” Note: This parameter must be set to “No” for Direct IP Calling to work.
Enable Fix for RTP Timestamp Jump	Makes RTP timestamps be continuous, if there is audio loss caused by timestamp jump. Default is “No”
Keep-alive Interval	Specifies how often the phone sends a blank UDP packet to the SIP server to keep the “ping hole” on the NAT router to open. The default setting is 20 seconds. The valid range is from 10 to 160.
STUN Server	The IP address or Domain name of the STUN server. STUN resolution results are displayed in the STATUS page of the Web GUI. Only non-symmetric NAT routers work with STUN.
Use NAT IP	The NAT IP address used in SIP/SDP messages. This field is blank at the default settings. It should ONLY be used if it’s required by your ITSP.
Delay Registration	Configures specific time that the account will be registered after booting up.
Enable Outbound Notification	Indicates whether Outbound Notification feature is enabled. Default is “Enabled”. For more details refer to [OUTBOUND NOTIFICATION SUPPORT].
Customized Station Label	Configures a customized station label that will be displayed on the status bar of the LCD screen. If this field is left blank (default), the banner will show the display name of the preferred account/first available account.
Public Mode	
Enable Public Mode	Configures to turn on/off the public mode for hot desking feature. The default setting is “Disabled”.
Public Mode Username Prefix	Used as prefix of public mode login, when public mode is enabled
Public Mode Username Suffix	Used as suffix of user name in public mode login, when public mode is enabled.
Allow Multiple Accounts	If set to "No", then after the user logs in to the public mode account on LCD, only the public mode account can be used on the phone even though there are other configured SIP accounts. If set to "Yes", then after the user logs in to the public mode account on LCD, other configured SIP accounts on the phone can also be used. Note: This option requires enabling public mode to take effect.
Enable Remote Synchronization	Enables phone to automatically download current account’s setting from remote server and upload to the server. Default setting is “Disabled”.
Server Type	Allows users to choose the type of the server (TFTP, FTP or HTTP) that stores personal files of public account. Default is “TFTP”
Server Path	Defines server path that stores personal files of public account.

FTP/HTTP User Name	Specifies User Name to access FTP/HTTP server.
FTP/HTTP Password	Specifies Password to access FTP/HTTP server.
Login Timeout	Configures Login timeout in Minute in public mode. The default value is 10.
Pop-up Hidden Settings	
Hide Pop-up Options	Set options for hiding popup messages. The available options are: <ul style="list-style-type: none"> ● Disable: Show all popups (default). ● All success: Hide all success level popups. ● All success & All Info: Hide all info and success level popups. ● All success & All Info & All Warning: Hide all info, success and warning level popups.
Settings → Settings	
General	
Key Mode	<p>If set to “Line Mode”, the amount of VPKs will be the amount of lines you can have. If set to “Account Mode”, the lines will be grouped by account, so the VPKs could hold more lines in one account.</p> <p>For example, with line mode, when the line is in use, by pressing the VPK, nothing is going to happen. In Account Mode, when the line is in use, by pressing the VPK, a new line will be initiated.</p> <p>The default setting is “Account Mode”.</p>
Preferred Default Account	Selects the preferred default account when offhook/onhook dialing. When selected account is unavailable, system will fall back to use the first available account instead.
Select Account from LCD	Configures whether the user can use the Up/Down key to select an account in the idle screen.
Mute Key Functions While Idle	<p>Specifies the function of mute key in idle. Default setting is “DND”.</p> <p>When select “Idle Mute” and press Mute key while idle, the future incoming call will be answered with mute. When select “Disabled”, Mute key will not take effect while idle.</p> <p>The default setting is “DND”.</p>
Last Call Forward Always	<p>Configures to enable storing the last input number when entering number in the call screen after pressing the ForwardAll softkey.</p> <p>Default is “No”.</p>
Show SIP Error Response	Shows SIP error response information on LCD screen. The default setting is “Yes”.
Filter Characters	Enables the filtering of specific characters from a dialed number during outbound calls. The default value is [(0)-]+
Do Not Escape '#' as %23 in SIP URI	Replaces # by %23 for some special situations.
User-Agent Prefix	Configures the prefix in the User-Agent header.
Enable Enhanced Acoustic Echo Canceller	<p>Enables/Disables Enhanced Acoustic Echo Canceller (EAC) providing acoustic echo reduction which is required for full-duplex handsfree speaker phone functions on the phone.</p> <p>The default setting is “Yes”.</p>
Enable Hook Switch	When set to "No", disable hook switch completely; When set to "Yes, except answering call", hook switch cannot be used for answering call. The default is "Yes".

Disable Speaker Key	When set to "Yes", the user can disable the speaker key completely. When set to "For Ongoing Call", the user can not hang up the call using the speaker key.
Contact Source priority	Configures the order of the contact sources for ID lookup in incoming/outgoing calls.
Enable Partial Contact Number Lookup	<p>Enables/disables Partial Contact Number Lookup for incoming and outgoing calls which allows the device to display the caller's name during a call even if the number does not exactly match the number stored in the phonebook.</p> <p>This feature is particularly useful when the calling/called number includes a country code or other prefixes that differ from the number saved in the contacts.</p> <p>The default setting is "disabled".</p>
Minimum partial match length	<p>Sets the minimum number of digits that must match between the suffix of the call number and the suffix of the local contact number.</p> <p>Valid range is 4 to 15 and default setting is 7.</p>
Maximum partial match length	<p>Sets the maximum number of digits that must match between the suffix of the call number and the suffix of the local contact number.</p> <p>Valid range is 4 to 15 and default setting is 10.</p>
Outgoing	
Click-To-Dial Feature	<p>Enables Click-To-Dial feature. If this feature is enabled, user could click the green dial button on left top corner of phone's Web GUI, then choose the account and dial to the target number. The default setting is "Disabled".</p> <p>For more details refer to [CLICK-TO-DIAL].</p>
Enable Paging Call Mode	Configures if a user is able to dial out a paging call.
Enable Direct IP Call	<p>Enables Direct IP Call feature.</p> <p>The default setting is "Yes".</p>
Use Quick IP Call Mode	<p>When set to "Yes", users can dial an IP address under the same LAN/VPN segment by entering the last octet in the IP address.</p> <p>To dial quick IP call, off hook the phone, press # to switch to "Direct IP Call" mode and dial XXX (X is 0-9 and XXX <=255), phone will make direct IP call to aaa.bbb.ccc.XXX where aaa.bbb.ccc comes from the local IP address REGARDLESS of subnet mask. XX or X are also valid so leading 0 is not required (but OK). No SIP server is required to make quick IP call.</p> <p>The default setting is "No".</p>
Predictive Dialing Feature	Allows users to show/hide predictive dialing feature, when disabled, users will not see any predictive numbers while dialing a number. Default setting is "Enabled".
Predictive Dialing Source	<p>Searches sequentially the number while dialing based on the selected sources from these:</p> <ul style="list-style-type: none"> ● Local Phonebook ● Call History ● Remote Phonebook ● Feature Codes ● LDAP
Onhook Dial Barging	Allows incoming call to interrupt on-hook dialing when set to "Enabled". Default setting is "Enabled".

Off-hook Auto Dial	Configures a User ID/extension to dial automatically when the phone is off hook. The phone will use the first account to dial out. Default setting is “No”.
Off-hook Auto Dial Delay	Configures the number of seconds during which the phone will wait before dialing out when off-hook auto dial number is configured. The default is 4.
Off-hook Timeout (s)	If configured, when the phone is off hook, it will go on hook after the timeout (in seconds). The default value is 30 seconds. Valid range is from 10 to 60.
Enable Live Keypad	Enables to Dial out automatically the number punched in after the number of seconds that the user had set when the phone is off-hook. Default value is “No”
Live Keypad Expire Time	Sets the Live Keypad expiration time before initiating the call using the Live Keypad feature. Interval is between 2s and 15s. The default value is 5s.
Enable Auto Redial	Enables the phone to redial automatically when called number is busy. If enabled, the phone will prompt the user to start “automatic redial” or no. If yes, the phone will redial called number several times [Automatic Redial Times] with [Automatic Redial Interval] between each call. The user is guided via different prompts on phone’s LCD displaying number of remaining attempts, count-down to initiate next auto redial and allowing user to manually initiate the call without waiting for the specified interval [Automatic Redial Interval]. The phone will stop automatic redial after successful attempt (called party not busy) or after unsuccessful attempts [Automatic Redial Times]. Note: For auto redial feature to take effect, voicemail must be enabled for the called extension The default setting is “No”.
Auto Redial Times	The number of times to attempt to call using Automatic Redial feature. The valid range is 1 – 200. The default value is “10”.
Auto Redial Interval	The interval between each call attempt using Automatic Redial feature. The valid range is 1 – 360 seconds. The default value is “10”.
Bypass Dial Plan Through Call History and Directories	Enable/Disable the dial plan check while dialing through the call history and any phonebook directories. The default setting is “No”.
Enable Call Completion Service	When the automatic redial and call completion service are enabled, and the user makes a call to callee, when the callee is busy at the moment, phone will monitor callee’s status. Once the callee is available, phone will ask if user wants to redial again. The default setting is “No”.
Incoming	
Enable Incoming Call Popup	If set to “Yes”, phone will pop up an incoming call window to notify the call. If set to “No”, there will be no notification pop up on LCD when there is an incoming call. This way users will not get disrupted by unexpected popup call but still get notified by the flashing line LED. The default setting is “Yes”.
Enable Missed Call Notification	Allows users to show/hide the notification popup for missed calls. The default setting is “Yes”. Note: Currently the manually rejected calls are counted as missed calls
Return Code When Refusing Incoming Call	When refusing the incoming call. The phone will send the selected type of SIP message of the call. Available options are:

	<ul style="list-style-type: none"> • Busy (486). • Temporarily Unavailable (480). • Not found (404). • Decline (603). <p>Default setting is "Busy 486".</p>
Allow Incoming Call Before Ringing	<p>This allows incoming calls after dialed but before ringing. This can be used under custom user configuration based on need.</p> <p>Default setting is "No"</p>
Enable Call Waiting	<p>Enable the call waiting feature.</p> <p>The default setting is "Yes".</p>
Enable Call Waiting Tone	<p>Enables Call Waiting alert tone when another incoming call is received while a call is in progress.</p> <p>Default setting is "Yes".</p>
Ring For Call Waiting	<p>Configures the phone to ring instead of playing call waiting tone when handset or headset is used.</p> <p>The default setting is "No".</p>
Auto Answer Delay	<p>Configure the delay for automatically answering the incoming call. Valid range is 0 to 10 (second). The default value is 0 (which means auto answer is disabled).</p>
In Call	
Enable in-call DTMF Display	<p>Enables/disables the display of entered DTMF digits on the phone LCD during the call.</p> <p>The default setting is "Yes".</p>
Enable Sending DTMF via specific MPKs	<p>Allows certain MPKs to send DTMF in-call. This option doesn't affect Dial DTMF.</p> <p>The default setting is "No".</p>
Show On Hold Duration	<p>Show the duration of holding a call on the LCD.</p> <p>The default setting is "Yes".</p>
Enable Auto Unmute	<p>If the option is enabled, automatically unmute phone when an user unholds the call or establishes a new call. The default setting is "No".</p>
In-call Dial Number on Pressing Transfer Key	<p>Configures the number to be dialed as DTMF using TRANSFER button.</p>
Enable Busy Tone on Remote Disconnect	<p>Enables the busy tone heard in the handset when call is disconnected remotely.</p> <p>The default setting is "Yes".</p>
Transfer	
Enable Transfer	<p>Enables/disables transfer feature. If disabled, call transfer will not be possible.</p> <p>Default setting is "Yes".</p>
Hold Call Before Completing Transfer	<p>When set to "No", the phone will not hold the current call or the transfer target for an Attended Transfer. The default setting is "Yes".</p>

Attended Transfer Mode	<p>If set to “Static”, attended transfers can only be performed with pre-established calls. If set to “Dynamic”, attended transfers can be performed with pre-established calls OR be initiated during the transfer process. This option does not affect the user’s ability to perform blind transfers.</p> <p>The default setting is “Dynamic”.</p> <p>For more details about “Static” / “Dynamic” transfer, refer to the user guide.</p>
Call Park	
Enable Call Park Softkey	Enable call park service to use call park related softkeys.
Call Park Mode	<p>Select different implementations for call park softkeys:</p> <ul style="list-style-type: none"> ● FAC: Specific feature access codes related to Call Park need to be configured. These FACs have a lower priority compared to BLF call park related FACs. ● XSI: To use Call Park in XSI mode, the XSI service must be properly configured ● Transfer: FACs can be used in this mode, but they are optional.
Call Park Softkey Feature Code	FACs can be used in this mode, but they are optional. The system can be configured to either park the call or perform a blind transfer to a parking lot or a target number.
Call Park Retrieve Softkey Feature Code	FACs can be used in this mode, but they are optional. The system can be configured to either park the call or perform a blind transfer to a parking lot or a target number.
Group Call Park Softkey Feature Code	FACs can be used in this mode, but they are optional. The system can be configured to either park the call or perform a blind transfer to a parking lot or a target number.
DND	
Enable DND Feature	<p>If set to “No”, the user cannot turn on Do Not Disturb feature via MUTE key, MPK, or menu on LCD.</p> <p>The default setting is “Yes”.</p>
Return Code When Enable DND	<p>When DND is enabled, the phone will send the selected type of SIP message. Available options are:</p> <ul style="list-style-type: none"> ● Busy (486). ● Temporarily Unavailable (480). ● Not found (404). ● Decline (603). <p>Default setting is “Temporarily Unavailable (480)”.</p>
DND Override	<p>Allows the phone to accept certain incoming calls while set to DND mode.</p> <ul style="list-style-type: none"> ● Off: all incoming calls will not be accepted. ● Allow all: all incoming calls will be allowed. ● Allow Only Contacts: only incoming calls from numbers in the local phonebook will be accepted. ● Allow Only Favorites: only incoming calls from favorite numbers in the local phonebook will be accepted. <p>The default setting is “Off”.</p>
Conference	
Enable Conference	Enables the Conference feature. The default setting is "Yes".
BLF	

Enable BLF Pickup Screen	By enabling BLF Pickup Screen, when monitored BLF is ringing, GRP261x/GRP2624/GRP2634/GRP2670/GRP2650 will pop up a BLF information window. The default setting is “No”.
Enable BLF Pickup Sound	Gives the user the ability to set sound notification to the monitoring BLF line when it’s ringing, GRP261x/GRP2624/GRP2634/GRP2670/GRP2650 will play a sound to inform user. The default setting is “No”.
BLF Pickup Sound Except List	Configures the list to be playing BLF sound notification for “All Except” extensions in the list [BLF Pickup Sound Except List] or “Only Allow” extensions in the list [BLF Pickup Sound Only List]. The default setting is “Allow Except”.
Hide BLF Remote Status	Allows users to hide the Caller ID from showing at the BLF VPK and MPK. <ul style="list-style-type: none"> ● No: The VPK will flash between the Caller ID and the BLF account. ● Yes: The VPK will stay under the monitored account and only notify that there is an incoming call. The default setting is “No”.
IM	
Enable IM Popup	If set to “No”, phone will not show a pop up when receiving an IM. The default setting is “Yes”.
Instant Message Popup Timeout	Configures the number of seconds that the message will remain on screen. The valid range is 10 – 900. The default setting is “10”.
Play Tone On Receiving IM	If enabled, phone will play a short tone when receiving an IM during idle state. The default setting is “Disabled”.
Call Features	
Enable Active MPK Page	When the option is enabled, Active MPK Page on the extension boards will be disabled. The default setting is “No”.
Enable Active VPK Page	Enables Active VPK Page to be displayed on LCD when there are active VPKs. The default setting is “No”.
Enable Call Recording LCD Indicator	Configures whether to show the call recording indicator on LCD for local and remote call recording. Enabled by Default.
Local Call Recording Feature	Gives the ability to record calls locally while on the call screen, the available options are: <ul style="list-style-type: none"> ● No: the local record feature is disabled. ● Yes: the local record feature is enabled. ● Yes & Auto-Start: the local record feature is enabled and recording will automatically start. The default setting is “No”. Note: The IP phone displays a prompt when the storage for recording files is almost full. This alert helps users manage the space by deleting or transferring recordings to avoid storage issues.
Default call log type	Sets the default call log list after select MENU→CALL HISTORY . Broadsoft Call Log or Local Call Log option will only show its own list. Default option will keep both call log lists. The default setting is “Default”.

Saved Local Call Recording Location	Configures location where the recordings will be stored.
Replace the oldest call record	When enabled, the oldest call record will be replaced with the newest one when the storage is full. If the option is disabled, the call recording feature will stop recording automatically. Default is “Disabled”.
Download Local Call Recordings	When there are recordings presented, you may download them here. Note: The file name of the recording has been improved to include information such as the exact time and date of the call and the from/to accounts that are part of the call.
Settings → Ringtone	
Call Progresses Tones: <ul style="list-style-type: none"> ● System Ring Tone ● Dial Tone ● Second Dial Tone ● Message Waiting ● Ring Back Tone ● Call-Waiting Tone ● Busy Tone ● Reorder Tone 	Configures ring or tone frequencies based on parameters from local telecom. The default value is North American standard. Frequencies should be configured with known values to avoid uncomfortable high pitch sounds. Syntax: f1=val,f2=val[,c=on1/off1[-on2/off2[-on3/off3]]]; (Frequencies are in Hz and cadence on and off are in 10ms) ON is the period of ringing (“On time” in ‘ms’) while OFF is the period of silence. In order to set a continuous ring, OFF should be zero. Otherwise it will ring ON ms and a pause of OFF ms and then repeat the pattern. Up to three cadences are supported.
Call Waiting Tone Gain	Configures the call waiting tone gain to adjust call waiting tone volume (Low, Medium or High). The default setting is “Low”.
DTMF Tone Gain	Configures the DTMF tone gain to adjust DTMF tone volume (Off, Low, Medium or High). The default setting is “High”.
Speaker Ring Volume	Configures speaker ring volume. The valid range is 0 to 7. The default setting is 5.
Notification Tone Volume	Configures notification tone volume. The valid range is 0 to 7 and default setting is 5.
Call Tone Volume	Used to configure the call tones’ level in dB. Values range from -15 to 15.
Lock Speaker Volume	Lock volume adjustment when the option is enabled so it cannot be changed from phone LCD. The option can be set to: “No”, “Ring”, “Talk” or “Both”. Default setting is “No”.
Default Ringtone	Allows to set Default Ringtone as their Global ringtone. Note: The ring tone set in individual accounts have higher priority to this setting. If the user wants the default ring tone to be used globally, he needs to set the ring tone of each account to Default Ring Tone; Otherwise, it will be whichever the ring tone you set. Important: The Priority goes as: Contact Ring Tone → Account Ring Tone → Default Ring Tone.
Alert-info Remote Ringtone Download Timeout	Configures how long (in seconds) before the phone falls back to using the local ringtone if the Alert-Info remote ringtone fails to download.
Provision	
Total Number of Custom Ringtone Update	Configures the number of custom ringtones to update in the provisioning process. The phone will keep the specified number of the newest ringtone and ringtones beyond the limit revert to factory defaults. The default setting is 3. The valid range is 0 to 10. Example: If set to 3, the device will try to download and keep the downloaded ringtone 1, 2,

	and 3. Ringtones that follow 3 such as 4, 5, 6, 7, 8, 9, 10 will all be reset to the factory ringtone.
Settings → Multicast Paging	
Multicast Paging Function	Enable or disable multicast paging. The default setting is "No".
Allowed in DND Mode	Allow Multicast Paging when DND mode is enabled. Default Setting is "No".
Paging Barge	During active call, if incoming multicast page is higher priority (1 being the highest) than this value, the call will be held and multicast page will be played. The default setting is "Disabled".
Paging Priority Active	If enabled, during a multicast page if another multicast is received with higher priority (1 being the highest) that one will be played instead. The default setting is "Enabled".
Multicast Channel Number	Multicast Channel Number (0-50). 0 for normal RTP packets, 1-50 for Polycom multicast format packets.
Multicast Paging Codec	The codec for sending multicast pages, there are 5 codecs could be used: PCMU, PCMA, G.726-32, G.729A/B, G.722 (wide band), G.723.1. Default setting is "G.722(wide band)".
Multicast Sender ID	Outgoing caller ID that displays to your page group recipients (for multicast channel 1 – 50).
Multicast IGMP Interval	Configure interval for Multicast IGMP query. Valid range is 30-300 and default setting is 120.
Multicast Call Timeout(s)	Set timeout in seconds for multicast calls. If the duration of a multicast call exceeds this value, the call will automatically end. If set to 0, which is the default setting, the multicast call will not be ended.
Multicast Listening	Defines multicast listening addresses and labels. For example: <ul style="list-style-type: none"> • "Listening Address" should match the sender's Value such as: "237.11.10.11:6767" • "Label" could be the description you want to use. For details, please check the "Multicast Paging User Guide" on our Website.

Phone Settings Page Definitions

Network Page Definitions

Network Settings → Ethernet Settings	
Internet Protocol	Selects "IPv4 Only", "IPv6 Only", "Both, prefer IPv4" or "Both, prefer IPv6". The default setting is "IPv4 only".
IPv4 Address	
IPv4 Address	Allows users to configure the appropriate network settings on the phone to obtain IPv4 address. Users could select "DHCP", "Static IP" or "PPPoE". By default, it is set to "DHCP".
Host name (Option 12)	Specifies the name of the client. This field is optional but may be required by Internet Service Providers.

Vendor Class ID (Option 60)	Used by clients and servers to exchange vendor class ID.
PPPoE Account ID	Enter the PPPoE account ID.
PPPoE Password	Enter the PPPoE Password.
PPPoE Service Name	Enter the PPPoE Service Name.
Ipv4 Address	Enter the IP address when static IP is used.
Subnet Mask	Enter the Subnet Mask when static IP is used for IPv4.
Gateway	Enter the Default Gateway when static IP is used for IPv4.
DNS Server 1	Enter the DNS Server 1 when static IP is used for IPv4.
DNS Server 2	Enter the DNS Server 2 when static IP is used for IPv4.
Preferred DNS Server	Enters the Preferred DNS Server for IPv4.
IPv6 Address	
IPv6 Address Type	Allows users to configure the appropriate network settings on the phone to obtain IPv6 address. Users could select “Auto-configured” or “Statically configured” for the IPv6 address type.
Static IPv6 Address	Enter the static IPv6 address when Full Static is used in “Statically configured” IPv6 address type.
IPv6 Prefix Length	Enter the IPv6 prefix length when Full Static is used in “Statically configured” IPv6 address type.
IPv6 Prefix(64 bits)	Enter the IPv6 Prefix (64 bits) when Prefix Static is used in “Statically configured” IPv6 address type.
DNS Server 1	Enter the DNS Server 1 for IPv6.
DNS Server 2	Enter the DNS Server 2 for IPv6.
Preferred DNS server	Enter the Preferred DNS Server for IPv6.
802.1X	

802.1X mode	Allows the user to enable/disable 802.1X mode on the phone. The default value is disabled. To enable 802.1X mode, this field should be set to EAP-MD5, users may also choose EAP-TLS, or EAP-PEAPv0/MSCHAPv2. Note: EAP-PEAP encryption supports Microsoft servers.
802.1X Identity	Enter the Identity information for the 802.1x mode. Note: Letters, digits and special characters including @ and – are accepted.
MD5 Password	Enter the MD5 Password for the 802.1X mode. Note: Letters, digits and special characters including @ and – are accepted.
802.1X CA Certificate	Uploads / deletes the 802.1X CA certificate to the phone; or delete existed 802.1X CA certificate from the phone.
Network → Advanced Settings	
HTTP Proxy	Specifies the HTTP proxy URL for the phone to send packets to. The proxy server will act as an intermediary to route the packets to the destination.
HTTPS Proxy	Specifies the HTTPS proxy URL for the phone to send packets to. The proxy server will act as an intermediary to route the packets to the destination.
Bypass Proxy for	Configures the destination IP address where no proxy server is needed. The phone will not use a proxy server when sending packets to the specified destination IP address.
Layer 3 QoS for SIP	Defines the Layer 3 QoS parameter for SIP. This value is used for IP Precedence, Diff-Serv or MPLS. The default value is 26.
Layer 3 QoS for RTP	Defines the Layer 3 QoS parameter for RTP. This value is used for IP Precedence, Diff-Serv or MPLS. The default value is 46.
Release DHCP On Reboot	Configures whether the phone will release the DHCP lease on reboot. Disabled by Default.
Enable DHCP VLAN	Enables auto configure for VLAN settings through DHCP. Disabled by default.
Enable Manual VLAN Configuration	Enables/disables manual VLAN configuration. When this option is set to Disabled, the phone will bypass VLAN configuration and only use the DHCP VLAN to configure VLAN tag and priority. Default is “Enabled”.
Layer 2 QoS 802.1Q/VLAN Tag	Assigns the VLAN Tag of the Layer 2 QoS packets. The valid range is 0 – 4094. The default value is 0.
Layer 2 QoS 802.1p Priority Value	Assigns the priority value of the Layer2 QoS packets. The valid range is 0 – 7. The default value is 0.
PC Port Mode	Configure the PC port mode. When set to “Mirrored”, the traffic in the LAN port will go through PC port as well and packets can be captured by connecting a PC to the PC port. The default setting is “Enabled”.

PC Port VLAN Tag	Assigns the VLAN Tag of the PC port. The valid range is 0 – 4094. The default value is 0.
PC Port Priority Value	Assigns the priority value of the PC port. The valid range is 0 – 7. The default value is 0.
Enable CDP	Enables/Disables CDP “Cisco Discovery Protocol”. The default setting is “Enabled”.
Enable LLDP	Controls the LLDP (Link Layer Discovery Protocol) service. The default setting is “Enabled”.
LLDP TX Interval	Defines LLDP TX Interval (in seconds). Valid range is 1 to 3600. The default setting is “60”.
Maximum Transmission Unit (MTU)	Defines the MTU in bytes. The valid range is 576 – 1500. The default value is 1500 bytes.
Remote Control	
Action URI Support	Enables/disables action URI feature on the phone. The default setting is “Enabled”.
Remote control Pop up window support	Indicates whether the phone is enabled to pop up allow remote control. The default setting is “Enabled”.
Action URI allowed IP list	List of allowed IP address from which the phone receives action URI. The Allowed IP addresses are separated by a comma such as “192.168.1.1,192.168.1.2”. Set this field to “any” to allow any IP address to send Action URL to the phone. The default value is empty string which means no IP address is allowed for remotely control the phone.
CSTA Control	Indicates whether CSTA Control feature is enabled. Change of this configuration will need the system to reboot to take effect. The default setting is “Disabled”.
CTI Settings (GRP2614, GRP2615, GRP2616, GRP2624, GRP2634, GRP2636, GRP2650 & GRP2670 only)	
Affinity Support	Allows communication with GS Affinity CTI application to manage telephone calls from computer. If enabled, a reboot is required to establish the communication. Default is “Disabled”. GS Affinity CTI Application is available HERE and its User Guide HERE .
Preferred Account	Selects the account on which CTI support is enabled.
Static DNS Cache (Note: There will be an initial attempt to retrieve latest result from the configured DNS server. If the initial DNS query returns no results for the hostname or the DNS server cannot be reached, then the values in the static cache are used)	
NAPTR	NAPTR (Naming Authority Pointer) records are used to specify rules for rewriting one type of domain name to another, typically used for handling Uniform Resource Identifiers (URIs) within the domain, when you configure NAPTR in the static DNS cache, you are specifying custom rules for how specific URIs or domain names should be resolved, the options to configure are : <ul style="list-style-type: none"> ● NAPTR DNS Cache Name: The domain name to which this resource record refers.

	<ul style="list-style-type: none"> ● NAPTR DNS Cache Time Interval (s): The time interval that the resource record may be cached before the source of the information should again be consulted, Default value is 300 seconds. ● NAPTR DNS Cache Order: A 16-bit unsigned integer specifying the order in which the NAPTR records must be processed to ensure the correct ordering of rules. ● NAPTR DNS Cache Preference: A 16-bit unsigned integer that specifies the order in which NAPTR records with equal "order" values should be processed, with low numbers being processed before high numbers. ● NAPTR DNS Cache Replacement: The next name to query for SRV records. ● NAPTR DNS Cache Service: Specifies the service(s) available down this SRV record path.
SRV	<p>SRV records are DNS records used to identify servers that provide specific services, such as email, SIP (Session Initiation Protocol) servers, or other services, Configuring SRV in the static DNS cache allows you to specify which servers should be used for particular services, helping ensure that your IP phone connects to the correct servers for specific functions, the available options to configure are:</p> <ol style="list-style-type: none"> 1. SRV DNS Cache Name: The domain name string with SRV prefix. 2. SRV DNS Cache Time Interval (s): Specifies the time interval that the resource record may be cached before the source of the information should again be consulted. The default value is 300 seconds. 3. SRV DNS Cache Priority: Set the priority of this target host. 4. SRV DNS Cache Weight: Set server selection mechanism. 5. SRV DNS Cache Target: The domain name of the target host. 6. SRV DNS Cache Port: Set the port on the target host of this service.
A	<p>A records are used to map a domain name to an IPv4 address. They are the most common type of DNS record and are used to resolve domain names to IP addresses, Configuring A records in the static DNS cache allows you to manually specify the IP addresses associated with specific domain names, ensuring that your IP phone always connects to the intended destination, the options to configure are:</p> <ul style="list-style-type: none"> ● A DNS Cache Name: Set Hostname. ● A DNS Cache Time Interval: A DNS Cache Time Interval, Default is 300 seconds. ● A DNS Cache IP Address: A DNS Cache IP Address.
<p>Bluetooth Settings (GRP2614, GRP2615, GRP2616, GRP2624, GRP2634, GRP2636, GRP2650 & GRP2670 only)</p> <p><i>Note: These settings can be hidden from the WebUI and LCD by setting the P-value P22037 to 1.</i></p>	
Bluetooth Power	<p>Configures Bluetooth to power "On", "Off" or "Off & Hide Menu From LCD".</p> <p>If set "Off & Hide Menu From LCD", Bluetooth will be disabled, and users will not find Bluetooth settings on phone LCD Menu, while if set to "No", Bluetooth will be disabled, and Bluetooth Settings menu will be available, and user can enable it. The default setting is "On".</p>
Handsfree Mode	<p>Enable / disable Bluetooth handsfree feature. Default setting is "Off".</p>
Bluetooth Name	<p>Specifies the Bluetooth device name.</p>
<p>OpenVPN® Settings</p>	
OpenVPN® Enable	<p>Enables/Disables OpenVPN® feature. Default is "No".</p>
OpenVPN® Mode	<p>Selects OpenVPN® mode to use:</p> <ul style="list-style-type: none"> ● Simple mode: Using simple mode, the administrator needs to configure the OpenVPN settings below. ● Expert mode: After switching to "expert mode", the administrator can manually upload a single OpenVPN client(.ovpn) file
Upload OpenVPN® config zip file	<p>Upload OpenVPN® .zip file containing .ovpn file when OpenVPN® Mode is set to "Expert Mode"</p> <p>Note: This field appears only when "OpenVPN® Mode" is set to "Expert Mode".</p>

OpenVPN® Server Address	Specify the IP address or FQDN for the OpenVPN® Server.
OpenVPN® Port	Specify the listening port of the OpenVPN® server. The valid range is 1 – 65535. The default value is “1194”.
OpenVPN® Server Secondary Address	Allows the user to configure a secondary OpenVPN® server as a backup in case the primary server is down. If “Randomly Select Server” is enabled, the server will randomly be chosen instead of starting with the primary server address.
OpenVPN® Secondary Port	Configure OpenVPN® Secondary Port.
Randomly Select Server	If enabled, a server will be randomly selected for OpenVPN® requests. If disabled, requests will be made in the order of the server configuration. This setting is disabled by default.
OpenVPN® Transport	Specify the Transport Type of OpenVPN® whether UDP or TCP. The default value is “UDP”
OpenVPN® CA	Click on “Upload” to upload the Certification Authority of OpenVPN®. For a new upload, users could click on “Delete” to erase the last certificate, and then upload a new one.
OpenVPN® Certificate	Click on “Upload” to upload OpenVPN® certificate. For a new upload, users could click on “Delete” to erase the last certificate, and then upload a new one.
OpenVPN® Client Key	Click on “Upload” to upload OpenVPN® Key. For a new upload, users could click on “Delete” to erase the last certificate, and then upload a new one.
OpenVPN® Client Key Password	Configures the password for the client.key file.
OpenVPN® TLS Key	Click on “Upload” to upload OpenVPN® TLS Key.
OpenVPN® TLS Key Type	Specifies the OpenVPN® TLS Key type. The available options are: <ul style="list-style-type: none"> ● None ● TLS-Auth ● TLS-Crypt ● TLS-Crypt V2
OpenVPN® Cipher Method	Specifies the Cipher method used by the OpenVPN® server. The available options are: <ul style="list-style-type: none"> ● Blowfish ● AES-128 ● AES-256 ● Triple-DES The default setting is “Blowfish”.
OpenVPN® Username	Configures the optional username for authentication if the OpenVPN server supports it.

OpenVPN® Password	Configures the optional password for authentication if the OpenVPN server supports it.
OpenVPN® Comp-lzo	Configures enable/disable the LZO compression. When the LZO Compression is enabled on the OpenVPN server, you must turn on it at the same time. Otherwise, the network will be abnormal. Default value is YES.
Additional Options	Additional options to be appended to the OpenVPN® config file, separated by semicolons. For example, comp-lzo no;auth SHA25 Note: Please use this option with caution. Make sure that the options are recognizable by OpenVPN® and do not unnecessarily override the other configurations above.
SNMP Settings	
Enable SNMP	Enables/Disables the SNMP feature. Default settings is “No”.
Version	SNMP version. Select Version 1, Version 2 or Version 3. Default is “Version 3”.
Port	SNMP port. The valid range is 161, 1025-65535. The default value is “161”.
Community	SNMP Community.
SNMP Trap Version	Choose the Trap version of the SNMP trap receiver. <ul style="list-style-type: none"> • Trap Version 1 • Trap Version 2 • Trap Version 3 The default is “Trap Version 2”.
SNMP Trap IP	IP address of trap destination.
SNMP Trap port	Port of the SNMP trap receiver. The valid range is 162, 1025-65535. The default value is “162”.
SNMP Trap Interval	The interval between each trap sent to the trap receiver. The valid range is 1 – 1440. The default value is “5”
SNMP Trap Community	Community string associated to the trap. It must match the community string of the trap receiver.
SNMP Username	Username for SNMPv3
Security Level	<ul style="list-style-type: none"> • noAuthUser: Users with security level noAuthnoPriv and context name as noAuth. • authUser: Users with security level authNoPriv and context name as auth. • privUser: Users with security level authPriv and context name as priv.
Authentication Protocol	Select the Authentication Protocol: <ul style="list-style-type: none"> • None • MD5 • SHA The default setting is “None”.

Privacy ProtocolNone	Select the Privacy Protocol: <ul style="list-style-type: none"> • None • DES • AES
Authentication Key	Enter the Authentication Key.
Privacy Key	Enter the Privacy Key.
SNMP Trap Username	Username for SNMPv3 Trap.
Trap Security Level	noAuthUser: Users with security level noAuthnoPriv and context name as noAuth. authUser: Users with security level authNoPriv and context name as auth. privUser: Users with security level authPriv and context name as priv.
Trap Authentication Protocol	Select the Authentication Protocol: "None" or "MD5" or "SHA". The default setting is "None".
Trap Privacy Protocol	Select the Privacy Protocol: "None" or "AES/AES128" or "DES". The default setting is "None".
Trap Authentication Key	Enter the Trap Authentication Key.
Trap Privacy Key	Enter the Trap Privacy Key.
Wi-Fi Settings (Available on GRP2612W & GRP2614 & GRP2615 & GRP2616 & GRP2624 & GRP2634 & GRP2636 & GRP2650 & GRP2670 only) <i>Note: These settings can be hidden from the WebUI and LCD by setting the P-value P22038 to 1.</i>	
Wi-Fi Function	Enables / Disables the WiFi on the phone. Three options are available: <ul style="list-style-type: none"> • Disable • Enable • Disable & Hide Menu From LCD
Wi-Fi Band	<ul style="list-style-type: none"> • 5G & 2.4G • 5G • 2.4G
Country	Select the country where the phone will be operating.
ESSID	<ol style="list-style-type: none"> 1. Scan: Scan for available SSIDs to connect to. 2. Add Network: Configure manually the SSID name, the password, and select the security mode. Note: <ul style="list-style-type: none"> • Users can configure settings for each SSID individually using pvalue/alias. The item names in the configuration template have been updated to follow the format network.wifi.ssid.{i}..., where {i} corresponds to the SSID index and "0" corresponds to SSID 1. For example, to configure SSID 7, you would use the following entry in the template:

	<p><item name="network.wifi.ssid.6.essid">My_WiFi</item>. Please refer to the configuration templates in the "Wi-Fi Settings" section for the list of pvalues.</p> <ul style="list-style-type: none"> When upgrading to version 1.0.13.x, existing Wi-Fi settings are automatically migrated. However, downgrading to earlier firmware versions any changes made in version 1.0.13.x using pvalue/alias will not be carried over. For example, if you changed SSID name from A to B and configure the EAP Certificate for SSID 10 on fw 1.0.13.x via pvalue/alias, once you downgrade, the SSID name will be reverted to A and the EAP Certificate will be lost.
Security Mode	<p>The encryption type used to secure the Wi-Fi connection. The available options are:</p> <ol style="list-style-type: none"> None: if there is no security mode set on the SSID. WEP: Outdated and insecure Wi-Fi encryption protocol using RC4, easily compromised. WPA/WPA2: Improved Wi-Fi security using PSK, with WPA2 utilizing AES encryption.
Hidden Wi-Fi	<p>If enabled, the network does not broadcast its name (ESSID), requiring manual entry to connect.</p>
Password	<p>The pre-shared key (Wi-Fi password) or EAP authentication password, depending on the security mode.</p>
EAP Method	<p>Extensible Authentication Protocol for enterprise Wi-Fi. The options are:</p> <ul style="list-style-type: none"> PWD (EAP-PWD): Password-based authentication. TLS (EAP-TLS): Certificate-based authentication (most secure). PEAP (Protected EAP): Encrypted username/password authentication.
Identity	<p>Used as the primary username or identifier for authentication.</p>
Password	<p>The Wi-Fi password (for WPA/WPA2-PSK) or EAP authentication password.</p>
CA Certificate	<p>Allows to upload the Certificate Authority file that validates the server's certificate.</p>
Client Certificate	<p>Allows to upload the device's digital certificate for authentication.</p>
Client Certificate Password	<p>Password to unlock the client certificate.</p>
Phase 2 Authentication	<p>Inner authentication method (None or MSCHAPv2).</p>
Anonymous Identity	<p>Identity sent during the initial phase of authentication to protect privacy.</p>
Advanced	<p>Configures IPv4 and IPv6 modes.</p>
VoWLAN Target Delay	<p>Configures the amount of jitter buffer target delay over Wi-Fi.</p> <ul style="list-style-type: none"> Low is 100ms Medium is 200ms High is 400ms <p>The Default value is set to "Low".</p>
Network Settings → Management Interface	
Enable Secondary	<p>Enables/Disables the configuration of a Virtual Network Interface layered on top of the physical interface to separate management traffic from VoIP traffic. Default is No.</p>

Network Interface	
WEB/SSH via	Allow WEB/SSH access using “Secondary Network Interface” or “All Network Interface” which is the default setting.
SNMP via	Choose the interface used for SNMP. Default is "Primary Network Interface".
TR-069 via	Choose the interface used for TR-069. Default is "Primary Network Interface".
Syslog via	Choose the interface used for Syslog. Default is "Primary Network Interface".
Secondary Network Interface IPv4 Address	
802.1Q/VLAN Tag	Assigns the VLAN Tag of the Layer 2 QoS packets. Valid range is 0 to 4094. Default is 0.
802.1p Priority Value	Assigns the priority value of the Layer 2 QoS packets. Valid range is 0 to 7. Default is 0.
IPv4 Address Type	The IPv4 address obtained on the phone using which method: <ul style="list-style-type: none"> • Dynamically assigned via DHCP. • Statically configured as.
IPv4 Address	Enter the static IP address used.
Subnet Mask	Enter the Subnet Mask when static IP is used.
Gateway	Enter the Default Gateway when static IP is used.
TR-069	
Enable TR-069	Enables TR-069
ACS URL	URL for TR-069 Auto Configuration Servers (ACS). Default setting is: https://euacs.gdms.cloud
TR-069 Username	ACS username for TR-069.
TR-069 Password	ACS password for TR-069.
Periodic Inform Enable	Enables periodic inform. If set to “Yes”, device will send inform packets to the ACS. The default setting is “No”.
Periodic Inform Interval	Sets up the periodic inform interval to send the inform packets to the ACS. Default is 86400.
Connection Request	The username for the ACS to connect to the phone.

Username	
Connection Request Password	The password for the ACS to connect to the phone.
Connection Request Port	The port for the ACS to connect to the phone.
CPE SSL Certificate	The Cert File for the phone to connect to the ACS via SSL.
CPE SSL Private Key	The Cert Key for the phone to connect to the ACS via SSL.
Start TR-069 at Random Time	When enabled, TR-069 will send out first INFORM message to server on randomized timing between 1 to 3600 seconds after phone boots up.

Network Page Definitions

Programmable Keys Page Definitions

Programmable keys → Multi-Purpose Keys (GRP2614 & GRP2616 & GRP2634 & GRP2636 only)	
Keys Settings	
Mode	<p>Speed Dial:</p> <ul style="list-style-type: none"> Select the Account to dial from. And enter the Speed Dial number in the Value field to be dialed or enter the IP address to set the Direct IP call as Speed Dial. <p>Busy Lamp Field (BLF):</p> <ul style="list-style-type: none"> Select the Account to monitor the BLF status. Enter the extension number in the Value field to be monitored. <p>Presence Watcher:</p> <ul style="list-style-type: none"> This option has to be supported by a presence server and it is tied to the phone SIP status based on the following LED indications : <ol style="list-style-type: none"> Green : Available / Away / Custom Status. Red : Chat / DND. Off : Unavailable. <p><i>Note</i> : It is recommended to use VPKs for presence watcher as it provides more visibility on the SIP status of the monitored extension (<i>with the exception of GRP2614 and GRP2616 which support Graphic LCD Display for MPKs</i>).</p> <p>Eventlist BLF:</p> <ul style="list-style-type: none"> This option is similar to the BLF option but in this case the PBX collects the information from the phones and sends it out in one single notify message. PBX server has to support this feature. <p>Speed Dial via active account:</p> <ul style="list-style-type: none"> Similar to Speed Dial but it will dial based on the current active account. For example, if the phone is offhook and account 2 is active, it will call the configured Speed Dial number using account 2 <p>Dial DTMF:</p> <ul style="list-style-type: none"> Enter a series of DTMF digits in the Value field to be dialed during the call. "Enable MPK Sending DTMF" has to be set to "Yes" first. <p>Voicemail:</p>

- Select Account and enter Voicemail access number in the Value field.

Call Return:

- The last answered calls can be dialed out by using Call Return. The Value field should be left blank. Also, this option is not binding to the account and the call will be returned based on the account with the last answered call.

Transfer:

- Select Account and enter the number in the Value field to be transferred (blind transfer) during the call.

Call Park:

- Select Account and enter the call park extension in the Value field to park/pick up the call.

Intercom

- Select Account and enter the extension to which you will send the intercom

LDAP Search:

- This option is to narrow the LDAP search scope. Enter the LDAP search base in the Description field. It could be the same or different from the Base in LDAP configuration under Advanced Settings. The Base in LDAP configuration will be used if the Description field is left blank. Enter the LDAP Name/Number filter in the Value field.

For example:

If users set MPK 1 as “LDAP Search” for “Account 1”, and set filters:

Description -> ou=video,ou=SZ,dc=grandstream,dc=com

Value -> sn=Li

Since the Base for LDAP server configuration is: “dc=grandstream,dc=com”, “ou=video,ou=SZ” is added to narrow the LDAP search scope. “sn=Li” is the example to filter the last name.

Conference:

- Allow user to set their Multi-Purpose Key to “Conference” mode to trigger a conference.
- By setting the extension number in the value box, the users will be able to activate a conference by simply pressing the assigned MPK button.

Multicast Paging:

- Allows the user to configure the address to send a multicast page to.

Record:

- Select this option to manually start recording during calls.

Call Log:

- Select Account and enter account number in the Value field to allow configuration of call log for other extension.

Monitored Call Park:

- Select account from Account field and enter the call park extension in the Value field to park/pick up the call, and also monitor the parked call via Line Key’s light.

Menu:

- Select this feature in order to display the Menu from the MPK buttons, no field dis required for configuration.

Information:

- Select this feature in order to display the Information popup to show the firmware version, MAC address, IP address and IP Settings from the MPK buttons, no field dis required for configuration.

Message:

- Select this feature in order to display the Message menu from the MPK buttons, no field dis required for configuration.

Forward:

- Set the MPK Button to perform call forwarding to the destination number configured on the “Value Field”. During ringing press the button to perform the call forward.

DND:

- Press the configured key to enabled/Disable DND.

Redial:

- On this mode, the configured key can be used to redial numbers.

Presence Eventlist:

- This option is similar to the Presence Watcher option but in this case the PBX collects the information from the phones and sends it out in one single notify message.

Note: The PBX server has to support this feature.

Provision:

- Select this feature in order to make the phone trigger an instant provisioning

Opendoor:

- Select this feature in order to make the phone trigger an open-door action in conjunction with a GDS37xx

Multicast Listen Address:

- This feature sets up a multicast listening address for the IP Phone.

Multicast Paging Address:

- This Feature sets up a Multicast paging address for paging purposes.

Note: An MPK configuration tutorial video link can be found on the MPK configuration page.

HTTP Command:

- This Feature sets up a call through an HTTP command

Silent call

- The feature allow you to initiate calls from a hardware V2 phone (HW V2), to an extension without any visual indication on the LCD screen, providing discreet calling where the call's status remains hidden.

Account	Select the account to be associated with the configured MPK.
Value	Enter the value to be associated with the configured MPK. (Extension Number, Multicast address...)
Label	Enter the name to be associated with the MPK.
Preview	Shows a preview of the configured MPK label.
Print	Click to print the configured MPK label shown in the preview.

Programmable Keys → Virtual Multi-Purpose Keys

Mode	<p>Allows the user to configure VPKs with modes such as Shared line, BLF and Speed Dial. Modes:</p> <ul style="list-style-type: none"> ● None ● Line ● Shared ● Speed Dial ● BLF ● Presence Watcher ● Eventlist BLF ● Speed Dial via Active Account ● Dial DTMF ● Voice Mail ● Call Return ● Transfer ● Call Park ● Intercom ● LDAP Search ● Conference ● Multicast Paging
-------------	---

	<ul style="list-style-type: none"> ● Record ● Call Log ● Monitored Call Park ● Menu ● Information ● Messages ● Forward ● DND ● Redial ● Multicast Listen Address ● Presence Eventlist ● Provision ● Multicast Paging Address ● HTTP Command ● Silent Call
Account	Select the account to be associated with the configured MPK.
Value	Enter the value to be associated with the configured MPK. (Extension Number, Multicast address...)
Label	Enter the label of the configured MPK.
Locked	Choose whether to lock a specific Virtual multi-purpose Key or not. All the keys are not locked by Default.
Programmable keys → USB MPK Key	
Mode	<p>Allows the user to configure an MPK Mode that triggers when the connected USB device is used, the connected USB device must be one of the USB-wired headsets supported by Grandstream GRP261x IP phone models. please refer to the following guide for more information about headset compatibility: GRP261x/262x/263x/26x0 Series - Headset Compatibility.</p> <p>The Modes that can be defined are:</p> <ul style="list-style-type: none"> ● None: no action will be performed. ● Speed Dial: A speed dial will be triggered. ● Silent Call: A silent call will be triggered, the silent call is a call that will be triggered without displaying the call screen. <p>Note: The USB key mode is supported on hardware version 2 phones only (HW V2).</p>
Account	Select the account to be associated with the configured USB MPK Key.
Value	Enter the value to be associated with the configured MPK. (Extension Number for Example)
Label	Enter the label of the configured USB MPK.
Enable Local In-call DTMF Tone in Speaker Mode	Configures whether to play local DTMF tone during call when using speaker. Enabled by Default.
Programmable Keys → Idle Screen Softkeys	
Custom Idle Screen Softkey Layout	Enables/disables softkey layout.Default is disabled
Custom Softkey	Press on the Add Custom Softkey radio button to add/configure up to 3 custom softkeys. Supported key modes are:

	<ul style="list-style-type: none"> ● Speed Dial ● Speed Dial Via active account ● Dial DTMF ● Voicemail ● Call Return ● Intercom ● LDAP Search ● Menu ● INFO ● Messages ● DND ● Contacts ● Multicast Paging Address ● Silent Call <p>You can also specify the Account, label, and Value (User ID)</p>
Custom Softkey Layout	The softkeys listed under the "Enabled" tab are displayed on the phone's idle screen. Select the softkey from the "Available" list to enable it. Up to 6 softkeys can be selected.
Programmable Keys → Call screen softkeys	
Custom Call Screen Softkey Layout	Enables/disables custom softkey layout Default is disabled
Enforce Softkey Layout Position	Whether to enforce the custom softkey layout position When set to 'YES', GUI will still preserve the space if the configured softkey is unable to show Disabled by Default
Custom Softkey	Press on Add Custom Softkey radio button to add/configure up to custom softkeys Supported key modes are speed dial, speed dial via active account and voicemail.
Custom Softkey Layout	<p>Dialing state:</p> <ul style="list-style-type: none"> ● Custom softkey layout when device is under DIALING state. ● Available softkeys: EndCall, Backspace, Dial, Share Line, Local Contacts, Remote Contacts 1, Remote Contacts 2, Remote Contacts 3, Remote Contacts, Call History, Voice Intercom <p>Ringling State:</p> <ul style="list-style-type: none"> ● Custom softkey layout when device is under RINGING state. ● Available softkeys: Answer, Reject, Forward, ReConf, Silence, GDS (Open door). <p>Calling State:</p> <ul style="list-style-type: none"> ● Custom softkey layout when device is under CALLING state. ● Available softkeys: End Call, ReConf, Conference Info, ConfCall, GDS (always enabled). <p>Call Connected State:</p> <ul style="list-style-type: none"> ● Custom softkey layout when the device is under CALL CONNECTED state. ● Available softkeys: End Call, ReConf, Conference Info, ConfCall, New Call, Swap, Transfer, CallPark, Dial DTMF, Record, Hold, Mute, GDS (Opendoor). <p>On Hold State:</p> <ul style="list-style-type: none"> ● Custom softkey layout when device is under ON HOLD state. ● Available softkeys: ReConf, Resume, Transfer, ConfCall, End Call, New Call. <p>Call Failed State:</p> <ul style="list-style-type: none"> ● Custom softkey layout when device is under CALL FAILED state. ● Available softkeys: End Call, ReConf, Conference Info, New Call. <p>Transfer State:</p>

	<ul style="list-style-type: none"> ● Custom Softkey layout when device is under TRANSFER state. ● Available softkeys: Cancel, Blind Transfer, Attended Transfer, Backspace. <p>Conference State:</p> <ul style="list-style-type: none"> ● Custom softkey layout when device is under CONFERENCE state. ● Available softkeys: Cancel, Dial, Backspace. <p>Conference Connected State:</p> <ul style="list-style-type: none"> ● Custom softkey layout when device is under CONFERENCE CONNECTED state. ● Available softkeys: End Call, Kick, New Call, Conference Info, ConfCall, Hold, Add, Split, Mute. <p>Onhook Dialing State:</p> <ul style="list-style-type: none"> ● Custom softkey layout when the device is under the ONHOOK DIALING state ● Available softkeys: End Call, Back Space, Dial.
Programmable Keys → Advanced settings	
Auto Provision List Starting Point	<p>Configures the type of keys that will be used first on the Auto Provision Eventlist BLF feature. the user can choose from the two options below:</p> <p>VPK (Virtual Programmable Key): Uses virtual programmable keys on the device.</p> <p>Exty APP: Utilizes Expansion Modules or Application-specific keys.</p>
More Softkey Display Mode	<p>Configures how to display more softkey options.</p> <ul style="list-style-type: none"> ● Menu: Users can select this option if they prefer to access additional softkey options through a menu. When this setting is enabled, activating the softkey might open a menu displaying a list of available actions or options for the user to choose from. ● Toggle: Users can choose this option if they prefer a more direct approach. With this setting enabled, softkey options might be presented as buttons or toggles on the interface, allowing users to turn specific functions on or off without navigating through a menu. <p>Default value is Menu</p>
Allow Programmable Key Configuration via LCD	<p>Enables/disables Programmable Key configuration via LCD by pressing and holding MPKs/VPKs.</p> <p>Enabled by Default.</p>
Show Target Softkey	<p>Configures whether to show Target softkey on LCD screen.</p> <p>Enabled by Default.</p>
Use Long Label	<p>If enabled, the VPK label will extend as desired.</p> <p>Enabled by Default.</p>
Enable Push-To-Talk	<p>Configures whether to enable Push-To-Talk. When enabled, long pressing on an Intercom VPK would switch to the Push-To-Talk functionality that initiates a call and ends the call when the key is released.</p> <p>The feature is disabled by default.</p>
Transfer Mode via Programmable Keys	<p>Configures the transfer mode to use when pressing the "Transfer" MPK.</p> <p>Choose from Blind Transfer, Attended Transfer, or New Call, All for selection.</p>
Enable Transfer via Non-Transfer Programmable Keys	<p>MPK with type BLF, Speed dial, etc., will perform as transfer MPK under active call</p>

Enable Transfer via Different Accounts	If enabled, Transfer via Programmable Keys will allow transferee and transferor from different accounts to send transfer request, but such request may fail if server cannot handle it.
Show Keys Label	<p>This option defines how the VPKs will show up on the call screen. The options are:</p> <ul style="list-style-type: none"> ● Show: Display the VPK labels using default width (reduced size). ● Hide: Only display the VPK's icon. ● Toggle: Allow users to switch between Show/Hide mode by long pressing the VPK. ● Extend: ShowLabel/HideLabel softkey will be available on call connected screen to show/hide full text on VPK. <p>The default setting is "Show".</p>
Font size on extension Board	<p>Allows the user to configure the font size of text displayed on the extension board(s), you can set it to Normal, Small or Large.</p> <p>It is set to Normal by Default.</p> <p>Note: GRP2615/GRP2624/GRP2650/GRP2670 are the only GRP26xx models that support adding an extension Board to them.</p>

Programmable Keys Page Definitions

System Settings Page Definitions

Settings → Time and Language	
Date and Time	
NTP Server	Defines the URL or IP address of the NTP server. The phone may obtain the date and time from the server. The default setting is "pool.ntp.org".
Secondary NTP Server	Defines the URL or IP address of the NTP server. The phone may obtain the date and time from the server. Allow user to configure 2 NTP server domain names. GRP will loop through all the IP addresses resolved from them.
NTP Update Interval	Time interval for updating time from the NTP server. Valid time value is in between 5 to 1440 minutes. The default setting is "1440" minutes.
Allow DHCP Option 42 Override NTP Server	Defines whether DHCP Option 42 should override NTP server or not. When enabled, DHCP Option 42 will override the NTP server if it is set up on the LAN. The default setting is "No".
Time Zone	Configures the date/time used on the phone according to the specified time zone. The default setting is "Auto".
Allow DHCP Option 2 to Override Time Zone Setting	Allows device to get provisioned for Time Zone from DHCP Option 2 in the local server. The default setting is enabled.
Self-Defined Time Zone	<p>This parameter allows the users to define their own time zone, when "Time Zone" parameter is set to "Self-Defined Time Zone".</p> <p>The syntax is: std offset dst [offset], start [/time], end [/time]</p> <p>Default is set to: MTZ+6MDT+5,M4.1.0,M11.1.0</p> <p>MTZ+6MDT+5</p> <p>This indicates a time zone with 6 hours offset with 1 hour ahead (when daylight saving) which is U.S central time. If it is positive (+) if the local time zone is west of the Prime Meridian (A.K.A: International or Greenwich Meridian) and negative (-) if it is east.</p> <p>M4.1.0,M11.1.0</p> <p>The 1st number indicates Month: 1,2,3..., 12 (for Jan, Feb, ..., Dec)</p> <p>The 2nd number indicates the nth iteration of the weekday: (1st Sunday, 3rd Tuesday...)</p>

	<p>The 3rd number indicates weekday: 0,1,2,...,6(for Sun, Mon, Tues, ... ,Sat)</p> <p>Therefore, this example is the DST which starts from the First Sunday of April to the 1st Sunday of November.</p>
Date Display Format	<p>Configures the date display format on the LCD. The following formats are supported.</p> <ul style="list-style-type: none"> • yyyy-mm-dd: 2019-03-02 • mm-dd-yyyy: 03-02-2019 • dd-mm-yyyy: 02-03-2019 • dddd, MMMM dd: Saturday, March 02 • MMMM dd, dddd: March 02, Saturday <p>The default setting is yyyy-mm-dd.</p>
Time Display Format	<p>Configures the time display in 12-hour or 24-hour format on the LCD. The default setting is in 12-hour format.</p>
Show Date on Status Bar	<p>When enabled, date will be shown next to time on LCD status bar.</p> <p>Disabled by Default.</p>
Language	
Display Language	<p>Selects display language on the phone.</p>
Default Input Selection	<p>Configures the default input selection:</p> <p>Multi-Tap: multi-tap to switch character</p> <p>Shiftable: select input from available characters.</p> <p>Set to Multi-trap By Default.</p>
Auto language download	<p>Configures the device to download language files automatically from server.</p>
System Settings → Input method	
Input Method for Contacts	<p>Sets the input method for contacts, the input method can be as follows :</p> <ul style="list-style-type: none"> • 123 • ABC • abc • Ab2 • Q9 <p>The default input method is: 123</p>
Input Method for LDAP	<p>Sets the input method for LDAP, the input method can be as follows :</p> <ul style="list-style-type: none"> • 123 • ABC • abc • Ab2 • Q9 <p>The default input method is: 123</p>
System Settings → Security Settings	
Web/SSH Access	
SSH Access	

Enable SSH Access	If enabled, the phone will allow any SSH access to the phone. Enabled by Default.
SSH Port	Configures the port for SSH access. The default is 22.
SSH Public Key	If Uploaded, the phone will use public key authentication as an alternative option to password authentication.
Keypad Mode	
Configuration via Keypad Menu	Configures access control for keypad Menu settings. <ul style="list-style-type: none"> • Unrestricted: all options on the LCD menu can be accessed; • Basic settings only: only options for basic settings can be displayed on the LCD menu; • Constraint mode: accessing options other than basic settings will require permission; Locked mode: Menu is disabled. <ol style="list-style-type: none"> 4. Warning: If the admin password is lost while constraint mode is enabled, your device may become permanently unusable. Remember to be careful when using constraint mode to avoid irreversible damage. 5. 6.
Factory Reset Security Level	Configure the password inquiry for factory reset. In default, the device ask for password when "Configuration via Keypad Menu" is not unrestricted mode.
Web Access	
HTTP Web Port	Configures the HTTP port under the HTTP web access mode. The valid range is 80 – 65535. The default value is “80”.
HTTPS Web Port	Configures the HTTPS port under the HTTPS web access mode. The valid range is 443 – 65535. The default setting is “443”.
Web Access Mode	Sets the protocol for web interface. <ul style="list-style-type: none"> • HTTPS • HTTP • Disabled • Both HTTP and HTTPS The default setting is “HTTP”.
Web Access Control	Web access control by using Whitelist or Blacklist on incoming IP addresses.
Web Access Control List	Only allow the IP address list as a whitelist or restrict the IP address list as a blacklist to access the Web.
Web Session Timeout	Configures timer to logout web session during idle. The valid range is 2-60 min. The default value is 10 min
Validate Server Certificates	After enabling this feature, phone will validate the server’s certificate. If the server that our phone tries to register on is not on our list, it will not allow server to access the phone.
Web/Restrict mode Lockout Duration	Specifies the time in minutes that the web or LCD login interface will be locked out to user after five login failures. This lockout time is used for web login, and LCD restrict mode admin login. Range is 0-60 minutes. The default setting is “5”.

Web access Attempt Limit	Configure attempt limit before logout. Default is 5. Range is 1-10.
User Info Management	
Test Password Strength	Checks password strength to ensure better security, when it is enabled, the following criteria need to be met in the defined password: <ul style="list-style-type: none"> • Numerics (0-9) • Capital letters (A-Z) • Lower case (a-z) • Special characters ('.'/'@'*-'=, &?!%()~_#')
Enable User Web Access	Administrator can disable or enable user web access using this parameter. This option is disabled by default.
User Password	
New Password	Set new password for web GUI access as User. This field is case sensitive.
Confirm Password	Enter the new User password again to confirm.
Admin Password	
Current Password	The current admin password is required for setting a new admin password.
New Password	Set new password for web GUI access as Admin. This field supports 1 to 512 characters that are case-sensitive.
Confirm Password	Enter the new Admin password again to confirm.
Client Certificate	
Minimum TLS Version	Configures the minimum TLS version supported by the phone. The minimum TLS version must be less than or equal to the maximum TLS version. It can be set to TLS 1.1, TLS 1.0, or TLS 1.2. Set by default to TLS 1.1
Maximum TLS Version	Configures the maximum TLS version supported by the phone. The maximum TLS version must be greater than or equal to the minimum TLS version. It can be set to TLS 1.1, TLS 1.0, or TLS 1.2. Set to unlimited by default.
Enable/Disable Weak Cipher Suites	This feature defines the function for weak cipher suites. If set to "Enable Weak TLS Cipher Suites", allow users to encrypt data by weak TLS cipher suites. If set to "Disable Symmetric Encryption RC4/DES/3DES", allow users to disable weak cipher DES/3DES and RC4.
SIP TLS Certificate	SSL Certificate used for SIP Transport in TLS/TCP.
SIP TLS Private Key	SSL Private key used for SIP Transport in TLS/TCP.

SIP TLS Private Key Password	SSL Private key password used for SIP Transport in TLS/TCP.
Custom Certificate	The uploaded custom certificate will be used for SSL/TLS communication instead of the phone default certificate.
Trusted CA Certificate	
Trusted CA Certificates (1 – 6)	Allows to upload and delete the CA Certificate file to phone. Note: Users can either upload the file directly from web or they can choose to provision it from their cfg.xml file.
Load CA Certificates	Phone will verify the server certificate based on the built-in, custom or both trusted certificates list. The default setting is “Default Certificates”.
Keypad Lock	
Enable Keypad Locking	If set to “Yes”, the keypad can be locked by pressing and holding the STAR * key for about 4 seconds. And will also allow automatic locking.
Keypad Lock Type	If set to "Functional Keys", only "Functional Keys" will be locked but you are still allowed to make emergency calls. If set to "All Keys", all keys will be locked and no emergency calls can be made.
Password to Lock/Unlock	Password to Lock/Unlock
Keypad Lock Timer	Configures the timeout (in seconds) of idle screen for locking keypad. Valid range is 0 to 3600.
Emergency	Defines emergency call numbers. If multiple emergency call numbers are entered, they should be separated by ‘,’.
System Settings → Preferences	
Display Control	
LCD	
Backlight Brightness: Active	Configures the LCD brightness when the phone is active. The valid range is 10 to 100 where 100 is the brightest. Default value is 100.
Backlight Brightness: Idle	Configures the LCD brightness when the phone is idle. Valid range is 0 to 100 where 0 is off and 100 is the brightest. Default Value is 60.
Active Backlight Timeout	Configures the timeout interval of the LCD backlight. The valid range is 0 to 90.
Enable Missed Call Backlight	If set to “Yes”, the LCD backlight will be turned on when there is a missed call on the phone.
Blank Screen Timeout	Configures how long it waits to turn off LCD automatically during non-office hour under Standard Mode. The valid range is 0 to 90 minutes. 0 means disable Blank Screen feature.

VPK Paging Auto Return Timeout	Configures how long to wait before automatically switching to the initial VPK page (main screen). The valid range is 0 and 5 to 90 (in seconds). If set to 0, which is the default value, this option will be disabled. For any value between 5 and 90 seconds, the phone will automatically return to the first VPK page on timeout.
LED	
Line LED Color Scheme	Configures line key LED color scheme to Default or Light up mode. <ol style="list-style-type: none"> 1. <i>Default: off(idle)/green(in use)</i> 2. <i>Light up: green(idle)/red(in use)</i>
Wallpaper	
Wallpaper Source	Configures the location where wallpapers are stored. It can be set to Default, Download, USB, Uploaded, or Color Background. It is set to Default.
Wallpaper Server Path	Configures the directory or file path of wallpaper.
Upload Wallpaper	Sets the option to upload a wallpaper, Must be in JPG or PNG format. 500 KB or smaller. The recommended wallpaper dimensions are: <ul style="list-style-type: none"> • GRP2612/GRP2613/GRP2614: width: 320, height: 240, bit depth: 24. • GRP2624/GRP2634: width: 320, height: 240, bit depth: 24. • GRP2615/GRP2616/GRP2636: width: 480, height: 272, bit depth: 24. • GRP2650: width: 1280, height: 720, bit depth: 24. • GRP2670: width: 1024, height: 600, bit depth: 24.
Color Background	Enter a color to use in HEX format. e.g. #000000
Screensaver	
Screensaver	Configures to turn on/off the screensaver feature. It is set to ON by default if no VPK is active.
Use Programmable Keys in Screensaver	Continue to display programmable key LEDs and process keypresses in screensaver mode.
Screensaver Source	Configures location where the screensaver is loaded from. If from USB, please name the folder "screensavers" and put screensaver pictures there.
Show Date and Time	Configures whether to display date and time on screensaver.
Screensaver Timeout	Configures the minutes of idle time before the screensaver activates. Valid range is 3 to 60. Value by Default is 3.
Screensaver Server Path	Configures server path that contains screensaver definition XML.
Screensaver XML Download Interval	Configures the screensaver XML download interval (in minutes). If set to 0, automatic download will be disabled. Valid range is 5 to 720. Set to 0 By Default.

Busy Lamp Field (BLF)	
BLF LED Pattern	<p>Configures the color and pattern of the LED based on status updates.the options can be :</p> <ol style="list-style-type: none"> 1. Default. 2. Analog 3. Directional 4. Reserved (Red) 5. Reserved (Green) 6. Inverse
Disable VM/MSG Power Light Flash	<p>If Enabled, the VM/MSG light cannot flash even when there is an unread voicemail or message. Disabled by Default.</p>
BLF LED Pattern Explanation Form	<p>Contains a detailed explanation of the different LED Patterns available. and their light-flashing reaction.</p>
Audio Control	
Headset	
Headset Key Mode	<p>When the headset is connected to the phone, users could use the HEADSET button in “Default Mode” or “Toggle Headset/Speaker”.</p> <p>Default Mode:</p> <ul style="list-style-type: none"> • When the phone is in idle, press HEADSET button to off hook the phone and make calls by using headset. Headset icon will display on the screen in dialing/talking status. • When there is an incoming call, press HEADSET button to pick up the call-using headset. • When there is an active call using headset, press HEADSET button to hang up the call. • When Speaker/Handset is being used in dialing/talking status, press HEADSET button to switch to headset. Press it again to hang up the call. Or, press speaker/Handset to switch back to the previous mode. <p>Toggle Headset/Speaker:</p> <ul style="list-style-type: none"> • When the phone is in idle, press HEADSET button to switch to Headset mode. The headset icon will display on the left side of the screen • In this mode, if pressing Speaker button or Line key to off hook the phone, headset will be used. • When there is an active call, press HEADSET button to toggle between Headset and Speaker. <p>Disable Headset Key:</p> <ul style="list-style-type: none"> • In this mode, the headset key will be disabled, no action will be performed when pressing the headset key. <p>Default value is set to "Default Mode".</p>
Headset Type	<p>Selects a normal RJ9 headset, Plantronics EHS headset, Jabra EHS, or Sennheiser EHS for the headset type.</p>
Always Ring Speaker	<p>Configured to enable/disable the speaker to ring when the headset is used on "Toggle Headset/Speaker" mode.</p>
Group Listen with Speaker	<p>In a call, the phone will display a soft key to enable speaker listening when the audio mode handset or headset.</p>
EHS Headset Ringtone	<p>Select EHS headset ringtone.</p>
Headset TX Gain (dB)	<p>Configures the transmission gain of the headset. The default value is 0dB.</p>

Headset RX Gain (dB)	Configures the receiving gain of the headset. The default value is 0dB.
Enable Headset Noise Shield 2.0	When enabled, the remote party will not hear the environmental noise during a call using the headset. Choose according to the TX loudness of the earphone. When the TX loudness of the headset is loud, please select the "Loud Headset", and when the TX loudness of the headset is soft, please select the "Thin Headset". "Moderate Headset" is selected by default.
Handset	
Handset TX Gain (dB)	Configures the transmission gain of the headset. The default value is 0 dB.
Enable Handset Noise Shield 2.0	When the Handset Noise Shield feature is enabled, the remote party will hear less environmental noise during a call. If set to "High Shielding", most of the environmental noise can be shielded. If set to "Soft Shielding", some environmental comfort noise will remain for the remote party.
Upload Audio Parameter Mode	Developer function to upload audio parameters for different audio modes.
Upload Audio Parameter Volume	Developer function to upload audio parameters for each audio volumes.
Enable HAC	Provides users the option to enable hearing aid compatibility to optimize audio tuning on v2 phones, in comparison to v1 phones.
System Settings → Energy Saving	
Office Hours	Configures Energy Saving Control mode for Office Hours. If set to "Standard" mode, all energy-related features will function according to the individual configurations. If set to "Maximum" mode, the device will ignore all individual configurations and use the setting that will maximize energy saving. No customization is possible under this mode. If set to "Customized" mode, the device will ignore all individual configurations and use the setting that will maximize energy saving (similar to Maximum Energy Mode) but allows the user to override one or more sub-features.
Non-Office Hours	Configures Energy Saving Control mode for Non-Office Hours. If set to "Standard" mode, all energy-related features will function according to the individual configurations. If set to "Maximum" mode, the device will ignore all individual configurations and use the setting that will maximize energy saving. No customization is possible under this mode. If set to "Customized" mode, users can configure energy-saving options

System Settings Page Definitions

Maintenance Page Definitions

Maintenance → Upgrade and Provisioning
Firmware
Upgrade via Manually Upload

Upload Firmware File to Update	Upload and start upgrade firmware.
Upgrade via Network	
Firmware Upgrade via	Allows users to choose the firmware upgrade method via TFTP, HTTP or HTTPS.
Firmware Server Path	Defines the server path for the firmware server. Note: Protocol header can be added in the Firmware Server path (Eg:https://) without the need to configure it on the "Config Upgrade via" parameter, once configured, it will override the selection on the "FirmwareUpgrade via"
Firmware Server Username	The username for the firmware server.
Firmware Server Password	The password for the firmware server.
Firmware File Prefix	If configured, only the firmware with the matching encrypted prefix will be downloaded and flashed into the phone.
Firmware file Postfix	If configured, only the firmware with the matching encrypted postfix will be downloaded and flashed into the phone.
Config File	
Configure Manually	
Download Device Configuration	Click to download phone's configuration file in .txt format. Notes: <ul style="list-style-type: none"> • The configuration file does not include passwords or CA/Custom certificates. • GRP261x/GRP262x/GR263x/GRP2670/GRP2650 series allow the configuration of aliases to be non-case sensitive, to provide a more flexible and easy configuration process to the users.
Download Device Configuration (XML)	Click to download phone's configuration file in .xml format. Note: Configuration file does not include passwords or CA/Custom certificate
Download User configuration	This allows users to download part of the configuration that does not include any personal settings like Username and Passwords. Also, it will include all the changes manually made by user from web UI, or config file uploaded from "Upload Device Configuration", but not include the changes from the server provision via TFTP/FTP/FTPS/HTTP/HTTPS.
Upload Device Configuration	Uploads configuration file to phone.
Export backup Package	Export backup package which contains device configuration along with personal data.
Restore from Backup package	Click to upload backup package and restore.
Configure via Network	

Config Upgrade Via	Allows users to choose the config upgrade method: TFTP, FTP, FTPS, HTTP or HTTPS. The default setting is "HTTPS".
Config Server Path	Defines the server path for provisioning. Note: Protocol header can be added in the Config Server path (Eg:https://) without the need to configure it on the "Config Upgrade via" parameter, once configured, it will override the selection on the "Config Upgrade via"
Config Server Username	The username for the HTTP/HTTPS server.
Config Server Password	The password for the HTTP/HTTPS server.
Always Authenticate Before Challenge	Only applies to HTTP/HTTPS. If enabled, the phone will send credentials before being challenged by the server.
Config File Prefix	Enables your ITSP to lock configuration updates. If configured, only the configuration file with the matching encrypted prefix will be downloaded and flashed into the phone.
Config File Postfix	Enables your ITSP to lock configuration updates. If configured, only the configuration file with the matching encrypted postfix will be downloaded and flashed into the phone.
Authenticate Conf File	Authenticates configuration file before acceptance.
XML Config File Password	The password for encrypting XML configuration file using OpenSSL. This is required for the phone to decrypt the encrypted XML configuration file.
Provision	
Auto Upgrade	
Automatic Upgrade	Enables automatic upgrade and provisioning. The default setting is "No".
Automatic Upgrade Check Interval (m)	Specifies the time period to check for firmware upgrade (in minutes). The default value is 10080
Hour of the Day(0-23)	Defines the hour of the day to check the HTTP/TFTP/FTP server for firmware Upgrade or configuration files changes. The default value is 1.
Day of the Week(0-6)	Defines the day of the week to check HTTP/TFTP/FTP server for firmware. Upgrade or configuration files changes. The default value is 1.
Randomized Automatic Upgrade	Randomized Automatic Upgrade within the range of hours of the day or postpone the upgrade every X minute(s) by random 1 to X minute(s). The default setting is "No"
Firmware Upgrade and Provisioning	Specifies how firmware upgrading and provisioning request to be sent: Always Check for New Firmware, Check New Firmware only when F/W pre/suffix Changes, Always Skip the Firmware Check. The default setting is "Always Check for New Firmware".

Firmware Upgrade Confirmation	If set to “Yes”, the phone will ask the user to upgrade. If there is no response, the phone will proceed with the upgrade. If set to “No”, the phone will automatically upgrade without user input. Default is Yes.
DHCP Option	
Allow DHCP Option 43 and Option 66 Override Server	DHCP option 66 originally was only designed for TFTP server. Later, it was extended to support an HTTP URL. GRP phones support both TFTP and HTTP server via option 66. Users can also use DHCP option 43 vendor specific option to do this. DHCP option 43 approach has priorities. The phone is allowed to fall back to the original server path configured in case the server from option 66 fails. The default setting is “Yes”.
Allow DHCP Option 120 to override SIP Server	Enables DHCP Option 120 from local server to override the SIP Server on the phone. The default setting is “No”.
Enable DHCP Option 150	Configures whether to enable DHCP Option 150. this option is used to specify the address of the TFTP (Trivial File Transfer Protocol) server that the phone should use to download its configuration files and firmware updates. Enabled by Default.
Enable DHCP Option 160	Configures whether to enable DHCP Option 160. This option is used to specify the path to the phone's configuration file on the provisioning server. Enabled by Default.
Enable DHCP Option 161	Configures whether to enable DHCP Option 161. DHCP Option 161 is used to specify the address of a boot server or provisioning server that the phone should use to download its configuration files and firmware updates. Enabled by Default.
Config Provision	
Download and Process ALL Available Config Files	By default, device will provision the first available config in the order of cfgMAC, cfgMAC.xml, cfgMODEL.xml, cfg.xml and devMAC.cfg (corresponding to device specific, model specific, and global configs). If set to Yes, device will download and apply (overwrite) all available configs in the same order.
User Protection	When user protection is on, pvalues that user sets will not be changed by provision or provider.
3CX Auto Provision	Phone will multicast SUBSCRIBE for provision if this feature is enabled.
Manual Provision	
Provision	Start provision process for both firmware and config files.
Advanced settings	
Validate Hostname in Certificate	Configures to validate the hostname in the SSL certificate.
Enable SIP Notify Authentication	Device will challenge NOTIFY with 401 when set to Yes
Factory reset	Press Start to begin Factory Reset of the phone.

Maintenance → System Diagnosis	
Syslog	
Syslog Protocol	<p>If set to SSL/TLS, the syslog messages will be sent through secured TLS protocol to syslog server. Default setting is “UDP”.</p> <p>Note:</p> <ul style="list-style-type: none"> • The CA certificate is required to connect with the TLS server. • In case you want syslog settings and internal logs to be saved across a factory reset, you can define the pvalue 82307(maintain.syslog.persist.factoryreset) in the configuration file downloaded to be set to the value 1 which means it will save the configuration, the default value is 0, which means the syslog configuration won't be saved after a factory reset.
Syslog Server	<p>The URL or IP address of the syslog server for the phone to send syslog to.</p> <p>Note: By adding port number to the Syslog server field (i.e., 172.18.1.1:1000), the phone will send syslog to the corresponding port of that IP.</p>
Syslog Level	<p>Selects the level of logging for syslog. The default setting is “None”. There are 4 levels: DEBUG, INFO, WARNING and ERROR. Syslog messages are sent based on the following events:</p> <ul style="list-style-type: none"> • Product model/version on boot up (INFO level). • NAT related info (INFO level). • sent or received SIP message (DEBUG level). • SIP message summary (INFO level). • inbound and outbound calls (INFO level). • registration status change (INFO level). • negotiated codec (INFO level). • Ethernet link up (INFO level). • SLIC chip exception (WARNING and ERROR levels). • Memory exception (ERROR level).
Syslog Header Format	<p>Configures the preferred header format for Syslog. The options are:</p> <ul style="list-style-type: none"> • Legacy (Default setting) • RFC3164 Compliant <p>The RFC3164 compliant header begins with "PRI" which represents both the Facility (0 - 23) and severity level (0 - 7) of the event. The message includes the timestamp, hostname, process id and the log message.</p> <p>For more information regarding the representation of the numerical values for the facility and severity, please refer to RFC3164.</p>
Syslog Keyword Filter	<p>Syslog will be filtered based on keywords provided. If you enter multiple keywords, it should be separated by ‘,’. Please note that no spaces are allowed.</p>
Send SIP Log	<p>Configures whether the SIP log will be included in the syslog messages. The default setting is “No”.</p> <p>Note: By setting Send SIP Log to Yes, the phone will still send SIP log from syslog even when Syslog Level set to NONE.</p>
Packet Capture	
With RTP Packets	<p>Defines whether the packet capture file contains RTP or not. The default setting is “No”.</p>
Ping	
Ping	<p>Enter Ping target's IP address or URL and click on start.</p>

Traceroute	
Traceroute	Input target's IP address or URL and click on start
Maintenance → Outbound Notification	
Action URL	
Phone Status	
Setup Completed	Configures the Action URL to send when phone finishes setup process.
Registered	Configures the Action URL to send when phone successfully registers a SIP account.
Unregistered	Configures the Action URL to send when phone unregisters a SIP account.
Call Operation	
Off-hook	Configures the Action URL to send when phone is in off-hook state.
On-hook	Configures the Action URL to send when phone is in on-hook state.
Incoming Calls	Configures the Action URL to send when phone receives an incoming call.
Outgoing Calls	Configures the Action URL to send when phone places a call.
Missed Call	Configures the Action URL to send when phone has a missed call.
Established Call	Configures the Action URL to send when phone establishes a call.
Terminated Call	Configures the Action URL to send when phone terminates a call.
Blind Transfer	Configures the Action URL to send when phone performs Blind Transfer.
Attended Transfer	Configures the Action URL to send when phone performs Attended Transfer.
Hold Call	Configures the Action URL to send when phone places a call on hold.
Unhold Call	Configures the Action URL to send when phone resumes the call on hold.
Call Settings	
Enable DND	Configures the Action URL to send when phone enables DND.
Disable DND	Configures the Action URL to send when phone disables DND.
Enable Call Forward	Configures the Action URL to send when phone enables Call Forward.
Disable Call Forward	Configures the Action URL to send when phone disables call forward.

Destination	
Add Destination	<p>Sets a destination By configuring :</p> <ul style="list-style-type: none"> ● Destination Name ● Protocol : XMPP , SMTP ● Enable SSL : Disabled by Default. ● Server Address ● Port ● Domain ● Username ● Password ● New List Item ● From ● To ● Extra attributes Name and Value
Delete All Destinations	Deletes all the Registered Destinations
Notification	
Add Notification	<p>Sets a destination By configuring :</p> <ul style="list-style-type: none"> ● Event: Configures the event, which will trigger an outbound notification. ● Destination : Configures the name of the destination where the outbound notification will be sent to. ● Subject : Configures the subject of Email notification. This option is only applicable to SMTP protocol and it is not editable for other protocols. ● Message : Configures the message body or the outbound notification. ● Extra Attribute Name : Configure extra attribute's name reserved for specific attributes for a given notification in the future. ● Extra Attribute Value : Configures extra attribute's value reserved for specific attributes for a given notification in the future.
Delete All Notifications	Deletes all saved notifications
Maintenance → Voice Monitoring	
Session Report	
VQ RTCP-XR Session Report	When enabled, phone will send a session quality report to the central report collector at the end of each call.
Interval Report	
VQ RTCP-XR Interval Report	When enabled, phone will send an interval quality report to the central report collector periodically throughout a call.
VQ RTCP-XR Interval Report Period	Configure the interval (in seconds) of phone sending an interval quality report to the central report collector periodically throughout a call.
Alert Report	
Warning Threshold for Moslq	Configure the threshold value of listening MOS score (MOS-LQ) multiplied by 10. The threshold value of MOS-LQ causes the phone to send a warning alert quality report to the central report collector.

Critical Threshold for Moslq	Configure the threshold value of listening MOS score (MOS-LQ) multiplied by 10. The threshold value of MOS-LQ causes the phone to send a critical alert quality report to the central report collector.
Warning Threshold for Delay	Configure the threshold value of one way delay (in milliseconds) that causes the phone to send a warning alert quality report to the central report collector.
Critical Threshold for Delay	Configure the threshold value of one way delay (in milliseconds) that causes the phone to send a critical alert quality report to the central report collector.
Display Report	
Display Report on Web UI	When enabled, the phone will display the quality report on the Web GUI. Enabled by Default.
Display Report on LCD	When enabled, the phone will display the quality report on LCD. Disabled by Default.
Custom Display Layout on LCD	Sets available Items to be displayed on LCD report.
Maintenance → Scheduled Tasks	
Add	Configures a new shceduled task based on: <ul style="list-style-type: none"> ● Scheduled Tasks Type: Select the type of scheduled task: Scheduled Reboot, Scheduled lock, or Scheduled Forward, Set to Scheduled Reboot by Default. ● Repetition period: Configures the recurring day of the scheduled task: Every day, Every Week, Every Month, No Repeat, set to no-repeat by Default. ● Effective Time: Configures the effective time or time period of the scheduled task. Set to 00:00 by Default.
Delete	Deletes the Scheduled Tasks.

Maintenance Page Definitions

Application Page Definitions

Application → Web Service	
Use Auto Location Service	To enable or disable auto location services on the phone. (Reboot Required)
Application → XML Application	
Server Path	Configures the server path to download the idle screen XML file. This field can be an IP address or URL, with up to 256 characters. Users can define dynamic tokens in the server path that will be replaced with real-time values when fetching an XML application. Tokens should be defined within {} (e.g., http://192.168.1.1/xmlapp.xml?caller={caller_number}). Supported tokens include: <ul style="list-style-type: none"> ● call_account_number (current call account number, empty if no active call) ● call_sip_id (current call account SIP ID, empty if no active call) ● call_caller_number (current caller number, empty if no active call) ● call_caller_sip_id (current caller SIP ID, empty if no active call) ● model_name (device model name)

	<ul style="list-style-type: none"> ● mac_address (device MAC address) ● firmware_version (device firmware version)
Username	Configures the username of the XML application, this is used for XML authentication
Password	Configures the password of the XML application used for XML authentication
Softkey Label	Specifies the softkey name displayed on the idle screen for the users to enter the XML application.
Default Background Color	Configures the background color in HEX format. Default is transparent. e.g. #000000
Block Call Screen	Configures to block auto-switching to Call Screen when XML application is running. Disabled by Default
Enable XML Application Auto Launch	<p>Configures different launch points that can be used to automatically fetch XML applications from a unique server or URL. The XML application will be launched based on the following scenarios:</p> <ul style="list-style-type: none"> ● On Incoming Call: the phone will launch XML application when there is incoming call. ● On Boot Up: it will launch the XML application automatically after boot up ● When No Account Configured: it will only auto-launch the XML application when no account configured <p>Note: tokens can be used similarly to the default XML server path.</p>
Application → Contacts	
Contacts	
Add Contact	<p>Press Add to create a new contact. With the following attributes :</p> <ol style="list-style-type: none"> 1. First Name 2. First Name 3. Favorite. Disabled by Default 4. Company 5. Job 6. Job Title 7. Work 8. Home 9. Mobile 10. Conference 11. Accounts. Chooses to which account the contact will be added 12. Groups 13. Ringtone 14. Picture <p>Notes:</p> <ul style="list-style-type: none"> ● Entering a SIP URI/hostname (e.g., sip:204@example.com) for the number field enables serverless direct calls without SIP registration. This requires local DNS to resolve hostnames to IPs. ● The conference field allows to configure a conference number that can be used to join meetings directly from the contact information.
Delete All Contacts	Press to delete all contacts.
Group Management	
Add Group	Specifies Group's name to add new group. More than 30 Groups supported.
Delete All Groups	Deletes All groups on the list
Phonebook Management	

Enable Phonebook XML Download	Enables Phonebook XML download via HTTP, HTTPS, FTP or TFTP. The default setting is “Disabled”.
HTTP/HTTPS Username	The username for the HTTP/HTTPS server.
HTTP/HTTPS Password	The password for the HTTP/HTTPS server.
Phonebook XML Server Path	Configures the server path to download the phonebook XML. This field could be IP address or URL, with up to 256 characters.
Phonebook Download Interval	Configures the phonebook download interval (in minutes). If set to 0, automatic download will be disabled. The default value is 0. Valid range is 5 to 720 minutes.
Remove Manually-edited Entries on Download	If set to “Yes”, when XML phonebook is downloaded, the entries added manually will be automatically removed. The default setting is “Yes”.
Import Group Method	<ul style="list-style-type: none"> • When set to “Replace”, existing groups will be completely replaced by imported one. • When set to “Append”, the imported groups will be attended with the current one. The default setting is “Replace”.
Sort Phonebook by	Sort phonebook based on the selection of first name or last name. The default setting is “Last Name”.
Download XML Phonebook	Click on “Download” to download the XML phonebook file to local PC. Note: XML phonebook includes different phone number types that are categorized using the <Phone type="x"> attribute. The type parameter supports the following values: Work, Home, Mobile, Conference .
Upload XML Phonebook	Click on “Upload” to upload local XML phonebook file to the phone.
Phonebook Key Function	Configures the behavior of the Phonebook key.
Default Search Mode	Configures the default phonebook search mode. Can be set to either Quick Match or Exact Match. Set to quick Match by Default.
Replace Duplicate Items	Replaces duplicate items by name or number
Application → LDAP	
LDAP Protocol	Configures the LDAP protocol to LDAP or LDAPS. The default setting is “LDAP”. LDAPS is a feature to support LDAP over TLS.
Server Address	Configures the IP address or DNS name of the LDAP server.
Port	Configures the LDAP server port. The default port number is “389”.
Base DN	Configures the LDAP search base. This is the location in the directory where the search is requested to begin. Example: dc=grandstream, dc=com

	ou=Boston, dc=grandstream, dc=com
Username	Configures the bind “Username” for querying LDAP servers. Some LDAP servers allow anonymous binds in which case the setting can be left blank.
Password	Configures the bind “Password” for querying LDAP servers. The field can be left blank if the LDAP server allows anonymous binds.
LDAP Number Filter	Configures the filter used for number lookups. Examples: ((telephoneNumber=%)(Mobile=%)) returns all records which has the “telephoneNumber” or “Mobile” field starting with the entered prefix; (&(telephoneNumber=%) (cn=*)) returns all the records with the “telephoneNumber” field starting with the entered prefix and “cn” field set.
LDAP Name Filter	Configures the filter used for name lookups. Examples: ((cn=%)(sn=%)) returns all records which has the “cn” or “sn” field starting with the entered prefix; (!(sn=%)) returns all the records which do not have the “sn” field starting with the entered prefix; (&(cn=%) (telephoneNumber=*)) returns all the records with the “cn” field starting with the entered prefix and “telephoneNumber” field set.
LDAP Mail Filter	Configures the filter used for email lookups. Examples: ((mail=%)(mailBox=%)) returns all records which has the “mail” or “mailbox” field containing the entered filter value; (!(mail=%)) returns all the records which do not have the “mail” field containing the entered filter value; (&(mail=%) (cn=*)) returns all the records with the “mail” field containing the entered filter value and “cn” field set
LDAP Mail Attributes	Specifies the “mail” attributes of each record which are returned in the LDAP search result. This field allows users to configure multiple space separated email attributes.
LDAP Version	Selects the protocol version for the phone to send the bind requests. The default setting is “Version 3”.
LDAP Name Attributes	Specifies the “name” attributes of each record which are returned in the LDAP search result. This field allows the users to configure multiple space separated name attributes. Example: gn cn sn description
LDAP Number Attributes	Specifies the “number” attributes of each record which are returned in the LDAP search result. This field allows the users to configure multiple space separated number attributes. Example: telephoneNumber telephoneNumber Mobile
LDAP Display Name	Configures the entry information to be shown on phone’s LCD. Up to 3 fields can be displayed. Example: %cn %sn %telephoneNumber
Max Hits	Specifies the maximum number of results to be returned by the LDAP server. If set to 0, server will return all search results. The default setting is 50.
Search Timeout	Specifies the interval (in seconds) for the server to process the request and client waits for server to return. The default setting is 30 seconds.

Sort Results	Specifies whether the searching result is sorted or not. Default setting is “No”.
LDAP Lookup	Configures to enable LDAP number searching when dialing / receiving calls.
Lookup Display Name	Configures the display name when LDAP looks up the name for incoming call or outgoing call. This field must be a subset of the LDAP Name Attributes. Example: gn cn sn description
Exact Match Search	Search for exact match result. Default setting is “No”.
LDAP Dialing Default Account	Configures the default account used when dialing LDAP contact.
LDAP DNS Mode	Determines how DNS is used to locate LDAP servers. Options include: <ul style="list-style-type: none"> • A Record: Directly resolve a static hostname/IP for an LDAP server. • SRV: Use DNS service records to dynamically locate LDAP servers based on a predefined format. SRV records include hostnames, port numbers, and priority/weight values.
Application → Remote Phonebook	
The user can configure up to 3 XML Remote Phonebooks.	
Display Name	Configures the entry information to be shown on phone’s LCD.
URL	Configures the XML Phonebook URL.
Username	The user name for the phonebook.
Password	The password for the phonebook.
Remote Phonebook Update Interval	Configures the Remote Phonebook download Interval (in minutes). If set to 0, automatic download will be disabled. Valid range is 5 to 720.
Application → Call History	
Delete	Users can select an entry, then click “Delete” to remove it from the list.
Delete All	Click on Delete All to remove all Call History stored in the phone. Note: Users could use the drop-down list to show only selected call history type (All, Answered, Dialed, Missed, and Transferred) and use navigation keys to browse pages when many entries exist.

Application Page Definitions

External Service Page Definitions

External Service → GDS	
GDS	Connect to a GDS37XX and send OpenDoor request. <ul style="list-style-type: none"> • Service Type: Select GDS as service type.

	<ul style="list-style-type: none"> ● Account: The account to be used on the phone to interact with the GDS37XX. ● System Identification: A name or a number to identify the GDS37XX. ● System Number: The SIP extension or the IP address of the GDS37XX depending on the deployed scenario, Peering or Registration. ● Access Password: The password set on the GDS37XX to unlock the door. ● System Ringtone: Select the system ringtone from the dropdown list to be played when there is an incoming call from the configured system number of the GDS37xx. <p>Notes:</p> <ul style="list-style-type: none"> ● When using Peering scenario, on “System Number” field of the GRP26xx specify the IP address of the peered GDS37XX. ● When using Registration scenario and both GRP26xx and GDS37XX are registered on the same SIP server, specify the SIP extension of the GDS37XX on “System Number” field on GXP16XX. <p>The “Access Password” on GRP26xx should be matching “Remote PIN to Open the door” on GDS37XX.</p>
External Service → Call Center	
Call Center Codes	Set the disposition code and the unavailable code for quick selection on the phone side.
External Service → Broadsoft XSI	
Authentication Login	
Server	Broadsoft XSI server address with protocol.
Port	Port of the Broadsoft XSI server.
XSI Action Path	Configure the deployment path for Broadsoft XSI Actions. If it is empty, the path “com.broadsoft.xsi-actions” will be used.
XSI Authentication Type	Defines the authentication type to use login credentials or SIP credentials. If set to “Login Credentials”, please fill in User ID and Password in the following options; If set to “SIP Credentials”, please fill in user ID, Authentication ID, and Authentication Password.
BroadSoft User ID	Configures User ID for BroadSoft Xsi server.
Login Password	Configures password for BroadSoft Xsi server
Service Settings	
Sort Phonebook by	Sort phonebook based on the selection of first name or last name.
BroadSoft Directory Update Interval (m)	Configures the BroadSoft phonebook download interval (in minutes). If set to 0, automatic download will be disabled. Valid range is 5 to 4320.
Broadsoft Contacts Download Limit	The maximum contacts that can be downloaded for each BroadSoft XSI server directory. The valid range is from 0 to 2000. If set to 0, the server’s default contact limit will be used. If the total contact records returned by the server is larger than this limit then it will not be downloaded, and the device will be limited to remote search.
BroadSoft Contacts Search limit	The maximum remote search records that can be downloaded for the BroadSoft XSI server directory. The valid range is from 0 to 2000. If set to 0, there is no limit. If the search result

	total records exceed this value, it will not be downloaded, and you will need to narrow the search scope.
Network Directories	
Type	<p>Enable/Disable Broadsoft Network directories. The directory types are:</p> <ul style="list-style-type: none"> ● Group Directory: Enable/Disable and rename the BroadWorks Xsi Group Directory features on the phone. If keep the Name box blank, the phone will use the default name “Group” for it. ● Enterprise Directory: Enable/Disable and rename the BroadWorks Xsi Enterprise Directory features on the phone. If keep the Name box blank, the phone will use the default name “Enterprise” for it. ● Group Common: Enable/Disable and rename the BroadWorks Xsi Group Common Directory features on the phone. If keep the Name box blank, the phone will use the default name “Group Common” for it. ● Enterprise Common: Enable/Disable and rename the BroadWorks Xsi Enterprise Common Directory features on the phone. If keep the Name box blank, the phone will use default name “Enterprise Common” for it. ● Personal Directory: Enable/Disable and rename the BroadWorks Xsi Personal Directory features on the phone. If keep the Name box blank, the phone will use the default name “Personal” for it. ● Missed Call Log: Enable/Disable and rename the BroadWorks Xsi Missed Call Log features on the phone. If keep the Name box blank, the phone will use the default name “Missed” for it. ● Placed Call Log: Enable/Disable and rename the BroadWorks Xsi Placed Call Log features on the phone. If keep the Name box blank, the phone will use the default name “Outgoing” for it ● Received Call Log: Enable/Disable and rename the BroadWorks Xsi Placed Call Log features on the phone. If keep the Name box blank, the phone will use the default name “Incoming” for it.
Name	Defines the directory name.
External Service → BroadSoft IM&P	
Login Credentials	
Server	Configures BroadSoft IM&P server address. Usually it's not necessary to configure and it can already be found in the BroadSoft IM&P username.
Port	Configures port for the BroadSoft IM&P server. Default Port is 5222.
Username	Configures BroadSoft IM&P username. This is not the BroadSoft account username.
Password	Configures BroadSoft IM&P username. This is not the BroadSoft account username.
IM&P Settings	
BroadSoft IM&P	Configures to enable BroadSoft Instant Message and Presence Feature.
Associated BroadSoft Account	Configures the BroadSoft account to dial out with. IM&P contacts can be selected to dial out with if they have an extension number entry.
Auto Login	Configures whether or not to log in BroadSoft IM&P account at bootup.
Display Non-XMPP Contacts	Configures whether or not to display non-XMPP contacts associated with the BroadSoft IM&P user. Non-XMPP contacts will not display presence or status message.

External Service → E911 Service	
Enable E911	Enable Enhanced 911 call. Default is disabled
HELD Protocol	Configure HELD transfer protocol. HTTP or HTTPS
Configure HELD transfer protocol	The valid synchronization interval is between 30 to 1440 minutes. The synchronization is off when the interval is 0.
Location Server	Configure the primary Location Information Server (LIS) address
Location Server Username	Configure the user name of the primary Location Information Server (LIS)
Location Server Password	Configure the password of the primary Location Information Server (LIS)
Secondary Location Server	Configure the secondary Location Information Server (LIS) address
Secondary Location Server Username	Configure the user name of the secondary Location Information Server (LIS)
Secondary Location Server Password	Configure the password of the secondary Location Information Server (LIS)
HELD Location Types	Configure "locationType" element in the location request. "geodetic", "civic" and "location URI"
HELD Use LLDP Information	If "Yes", the information from LLDP-support switch is used to generate ChassisID and PortID; otherwise, the mac address of gateway and phone is used as default.
HELD NAI	If "Yes", Network Access Identifier (NAI) is included as a device identity in the location request sent to the Location Information Server (LIS)
E911 Emergency Numbers	A user can configure multiple emergency numbers separated with the delimiter symbol ";".
Geolocation-Routing Header	If "Yes", E.911 INVITE message includes the "Geolocation-Routing" header with the value "Yes"
Priority Header	If "Yes", E.911 INVITE message includes the "Priority" header with the value "emergency"

External Service Page Definitions

BLF LED PATTERNS

Pattern: Default	
Call's State	Light Indication
Offline	Off
Idle	Solid Green
Trying	Solid Red
Talking	Solid Red

Proceeding	Flashing Red
Incoming call	Flashing Red

Pattern: Directional	
Call's State	Light Indication
Offline	Off
Idle	Solid Green
Trying	Flashing Green
Talking	Solid Red
Proceeding (initator)	Flashing Green
Proceeding (Receiver)	Flashing Red
Incoming call	Flashing Red

Pattern: Analog	
Call's State	Light Indication
Offline	Off
Idle	Solid Green
Trying	Solid Red
Talking	Solid Red
Proceeding	Solid Red
Incoming call	Flashing Red

Pattern: Inverse	
Call's State	Light Indication
Offline	Off
Idle	Solid Red

Trying	Solid Green
Talking	Solid Green
Proceeding	Flashing Green
Incoming call	Flashing Green

Mode: Reserved (Red)	
Call's State	Light Indication
Offline	Off (Extension Board Icon: Off)
Idle	Off (Extension Board Icon: Idle)
Trying	Solid Red
Talking	Solid Red
Proceeding	Solid Red
Incoming call	Flashing Red

Mode: Reserved (Green)	
Call's State	Light Indication
Offline	Off (Extension Board Icon: Off)
Idle	Off (Extension Board Icon: Idle)
Trying	Solid Green
Talking	Solid Green
Proceeding	Solid Green
Incoming call	Flashing Green

PRESENCE LED PATTERNS

SIP Status	Light Indication
Available	Solid Green
Away	Solid Green
Unavailable	Off
Do Not Disturb	Solid Red
Chat	Solid Red
Custom Presence	Solid Green

PRESENCE LED Definitions

Note

Besides the SIP status light indications supported by the UCM SIP Server, the GRP261x, GRP2624, GRP2634, GRP2636, GRP2650, GRP2670 support customizable light indication based on the SIP Statuses defined by the specific SIP server deployed. Example : The following SIP Status light indications reflect the received SIP NOTIFY message based on the mentioned xml values :

- 1) "rpid:endpoint-registered" : Solid Green
- 2) "rpid:on-the-phone-ringing" : Blinking Green
- 3) "rpid:on-the-phone" : Solid Red
- 4) "rpid:on-the-phone-held" : Blinking Red

NAT SETTINGS

If the devices are kept within a private network behind a firewall, we recommend using STUN Server. The following settings are useful in the STUN Server scenario:

- o **STUN Server**

Under **Settings→General Settings**, enter a STUN Server IP (or FQDN) that you may have, or look up a free public STUN Server on the internet and enter it in this field. If using Public IP, keep this field blank.

- o **Use Random Ports**

It is under **Settings→General Settings**. This setting depends on your network settings. When set to "Yes", it will force random generation of both the local SIP and RTP ports. This is usually necessary when multiple GRPs are behind the same NAT. If using a Public IP address, set this parameter to "No".

- o **NAT Traversal**

It is under **Accounts X→Network Settings**. The default setting is "No". Enable the device to use NAT traversal when it is behind a firewall on a private network. Select Keep-Alive, Auto, STUN (with STUN server path configured too), or other options according to the network setting.

BLUETOOTH

Information:

Bluetooth is available on GRP2614/GRP2615, GRP2616, GRP2624, GRP2634, GRP2670 & GRP2650 only

Bluetooth is a proprietary, open wireless technology standard for exchanging data over short distances from fixed and mobile devices, creating personal area networks with high levels of security. GRP2614/GRP2615, GRP2616, GRP2624, GRP2634, GRP2670 & GRP2650 support Bluetooth. On the phone, users could connect to cell phones (supporting Bluetooth) via hands-free mode or use a Bluetooth headset for making calls.

To connect to a Bluetooth device, turn on the phone's Bluetooth radio first. The first time when using a new Bluetooth device with the GRP2614/GRP2615, GRP2616, GRP2624, GRP2634, GRP2670 & GRP2650 "pair" the device with the phone so that both devices know how to connect securely to each other. After that, users could simply connect to a paired device. Turn off Bluetooth if it's not used.

Bluetooth-related settings are under the phone's LCD **Menu**→**System**→**Bluetooth**.

For more details on Bluetooth features, please refer to:

[Using Bluetooth on GRP phones – Documentation Center \(grandstream.com\)](http://grandstream.com)

PACKET CAPTURE

GRP261x/GRP2624/GRP263x/GRP2670/GRP2650 is embedded with a packet capture function. The related options are under **Maintenance**→**Packet Capture**.

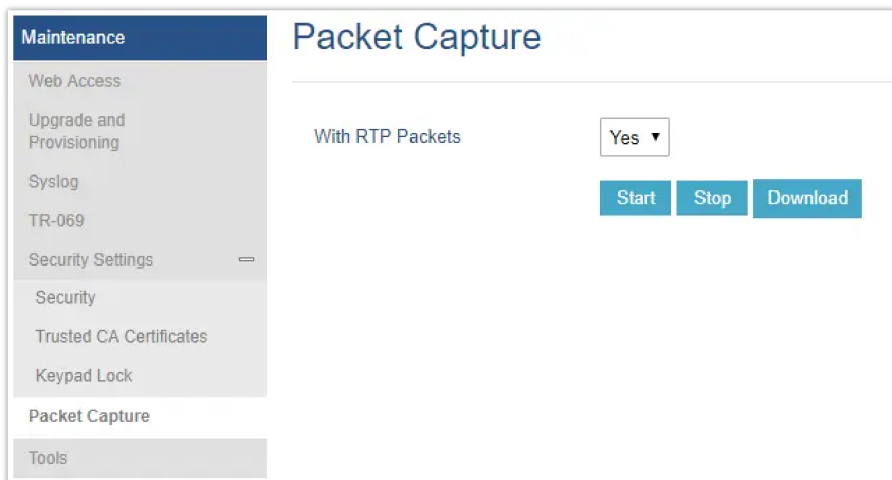

Packet Capture in Idle

Users can also define whether RTP packets will be captured or not from **With RTP Packets** option.

When the capture configuration is set, press the Start button to start packet capture. The Status will become RUNNING while capturing, as shown in Figure 6: Packet Capture when running. Press the **Stop** button to end the capture.

Press the Download button to download the capture file to your local PC. The capture file is in .pcap format.

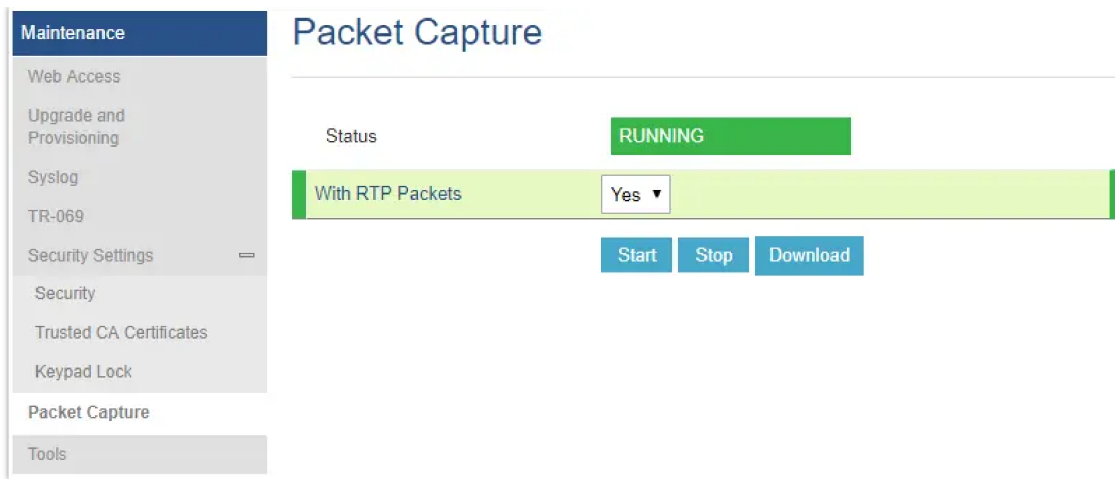

Packet Capture when running

CLICK-TO-DIAL

From GRP261x/GRP2624/GRP2634 Web GUI, users could dial out with the Click-to-Dial feature  on the top of the Web GUI.

Before using the Click-To-Dial feature, make sure the option "Click-To-Dial Feature" under web GUI→**Settings**→**Call Features** is turned on. If no account is registered, the icon will be in grey ; If the click to dial is disabled, but the account is registered, the icon will be in green, and clicking on the icon will do nothing.

When clicking on the  icon on the top menu of the Web GUI, a new dialing window will show for you to enter the number. Once Dial is clicked, the phone will go off-hook and dial out the number from the selected account. Please see [Figure 7: Click-to-Dial Feature]

Additionally, users could directly send the command for the phone to dial out by specifying the following URL in the PC's web browser, or in the field as required in other call modules.

http://ip_address/cgi-bin/api-make_call?phonenumber=1234&account=0&login=admin&password=admin

In the above link, replace the **fields** with

- **ip_address:**

Phone's IP Address.

- **phonenumber=1234:**

The number for the phone to dial out

- **account=0:**

The account index for the phone to make calls. The index is 0 for account 1, 1 for account 2, 2 for account 3, etc.

- **password=admin/123:**

The admin login password or user login password of the phone's Web GUI.

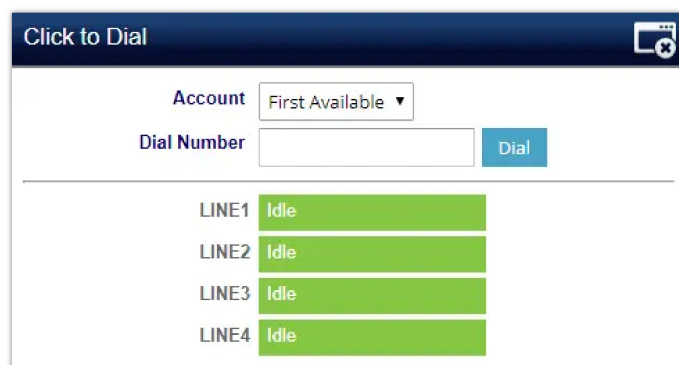

Click-to-Dial Feature

OUTBOUND NOTIFICATION SUPPORT

Outbound notification options can be found under device web UI→**Settings**→**Outbound Notifications**. In the web UI, there are three sections under Outbound Notifications: "Action URL", "Destination" and "Notification".

- **Action URL**

To use the Outbound Notification→Action URL, users need to know the supported events and the dynamic variables for the supported events. The dynamic variables for the supported events will be replaced by the actual values on the phone in order to notify the event to the SIP server.

Supported Events	
Setup Completed	Terminated Call
Registered	Open DND
Unregistered	Close DND
Off Hook	Open Forward
On Hook	Close Forward
Incoming Call	Blind Transfer
Outgoing Call	Attended Transfer
Missed Call	Hold Call
Established Call	UnHold Call

Action URL – Supported Events

Settings

- General Settings
- Broadsoft +
- External Service
- Call Features
- Multicast Paging
- Outbound Notification -
- Action URL**
- Destination
- Notification
- Preferences +
- Programmable Keys +
- Web Service
- XML Applications
- Voice Monitoring

Action URL

Setup Completed	<input type="text"/>
Registered	<input type="text"/>
Unregistered	<input type="text"/>
Off Hook	<input type="text"/>
On Hook	<input type="text"/>
Incoming Call	<input type="text"/>
Outgoing Call	<input type="text"/>
Missed Call	<input type="text"/>
Established Call	<input type="text"/>
Terminated Call	<input type="text"/>
Open DND	<input type="text"/>
Close DND	<input type="text"/>
Open Forward	<input type="text"/>
Close Forward	<input type="text"/>
Blind Transfer	<input type="text"/>
Attended Transfer	<input type="text"/>
Hold Call	<input type="text"/>
UnHold Call	<input type="text"/>

Save
Save and Apply
Reset

Action URL Settings Page

Supported Dynamic Variables	
Dynamic Variable	Description
\$phone_ip	The IP address of the phone
\$mac	The MAC address of the phone
\$product	The product name of the phone
\$program_version	The software version of the phone
\$hardware_version	The hardware version of the phone
\$language	The display language of the phone
\$local	The called number on the phone
\$display_local	The display name of the called number on the phone
\$remote	The call number on the remote phone

\$display_remote	The display name of the call number on the remote phone
\$active_user	The account number during a call on the phone

Action URL – Supported Dynamic Variables

After the user finishes setting the Action URL on the phone's web UI, when the specific phone event occurs on the phone, the phone will send the Action URL to the specified SIP server. The dynamic variables in the Action URL will be replaced by the actual values.

Here is an example:

Configure the following Action URL on the phone's web UI → Settings → Outbound Notification → Action URL:

Incoming Call: 172.18.24.103/mac=\$mac&local=\$local

Outgoing Call: 172.18.24.103/remote=\$remote&phone_ip=\$phone_ip

On hold: 172.18.24.103/program_version=\$program_version

During an incoming call, outgoing call, and call hold, capture the trace on the phone and exam the packets. We can see the phone sends an Action URL with actual values to the SIP server to notify phone events. In the following screenshot, from top to bottom, the phone events for each HTTP message are Incoming Call, Outgoing Call, and On Hold in the format of the defined action URL with the parameters replaced with actual values.

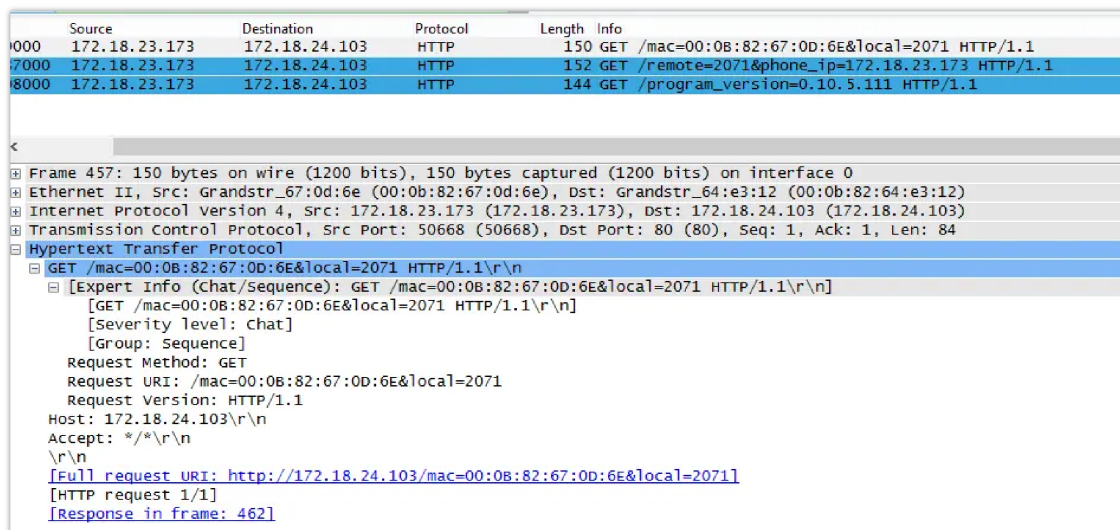

Action URL Packet

The P values listed in the table below are for the options under phone web UI → Settings → Outbound Notification → Action URL.

P Value	Web UI Option	Value Format
P8304	Setup Completed	String
P8305	Registered	
P8306	Unregistered	
P8308	Off Hook	
P8309	On Hook	
P8310	Incoming Call	

P8311	Outgoing Call
P8312	Missed Call
P8313	Established Call
P8314	Terminated Call
P8316	Open DND
P8317	Close DND
P8318	Open Forward
P8319	Close Forward
P8320	Blind Transfer
P8321	Attended Transfer
P8324	Hold Call
P8325	UnHold Call

Action URL Parameters P-values

o **Destination**

The options under the phone's web UI → Settings → Outbound Notification → Destination configure the server information destination of the outbound notification. Click on "Add Destination" and users will see the following window to configure destination server information.

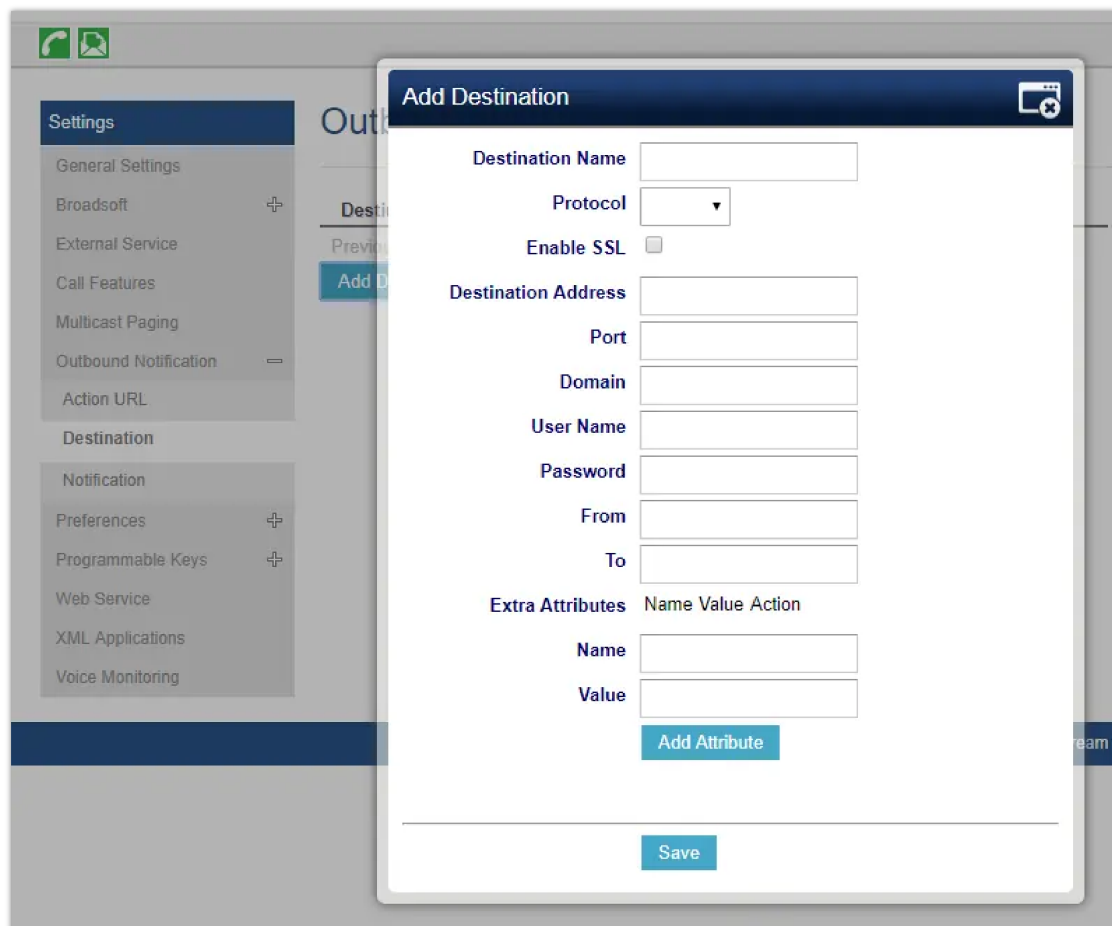

Action URL – Add Destination

The following table describes each option in the above interface.

Destination Server Option	Description
Destination Name	Identify the destination name. It must be unique.
Protocol	Configure the protocol associated with the destination server. Currently XMPP and SMTP are supported.
Enable SSL	Configure whether to use SSL to encrypt for SMTP protocol. This option is not editable for XMPP.
Destination Address	Configure destination server address, e.g., talk.google.com.
Port	Configure destination server port, e.g., 5222.
Domain	Configure the destination server domain for XMPP protocol. This option is not editable for SMTP.
User Name	Configure the authorization user name of the destination server.
Password	Configure the authorization user password for the destination server.
From	Configure the sender name for SMTP protocol. This option is not editable for XMPP.
To	Configure the receiver's address.
Extra Attribute Name	Configure extra attribute's name reserved for protocol specific attributes such as "jid" for XMPP protocol. If "jid" is specified, user name and domain will be overridden.
Extra Attribute Value	Configure extra attribute's value reserved for protocol specific attributes such as "abc@gmail.com" for "jid" of XMPP protocol. If it's specified, user name and domain will be overridden.

Action URL – Add Destination Settings

Up to 10 destinations can be configured here. The P-values are listed in the below table.

P Value	Destination	Value Format
----------------	--------------------	---------------------

P9910	Destination 1	<p>String. Each P value consists of all the options configured for this destination</p> <p>Example 1 - Destination 1 with protocol XMPP and 2 extra Attributes configured: P9910=serverName=destination1&protocol=XMPP&serverAddress=talk.google.com&port=5222&user=username1&password=password1&from=&&to=to1&domain=gmail.com&extraAttrName1=extraAttrValue1&extraAttrName2=extraAttrValue2</p> <p>Example 2 - Destination 2 with protocol SMTP and 3 extra Attributes configured: P9911=serverName=destination2&protocol=SMTP&serverAddress=smtps://smtp.gmail.com&port=465&user=username2&password=password2&from=username2&to=to2&domain=&&extraAttrName1=extraAttrValue1&extraAttrName2=extraAttrValue2&extraAttrName3=extraAttrValue3</p> <p>The BOLD strings in above examples are the actual values configured in each field for the destination.</p>
P9911	Destination 2	
P9912	Destination 3	
P9913	Destination 4	
P9914	Destination 5	
P9915	Destination 6	
P9916	Destination 7	
P9917	Destination 8	
P9918	Destination 9	
P9919	Destination 10	

Action URL – Destination P-values

o **Notification**

After configuring the destination server, users can configure notification information under the phone's web UI→Settings→Outbound Notification→Notification. Click on "Add Notification" and users will see the following window to configure the notification.

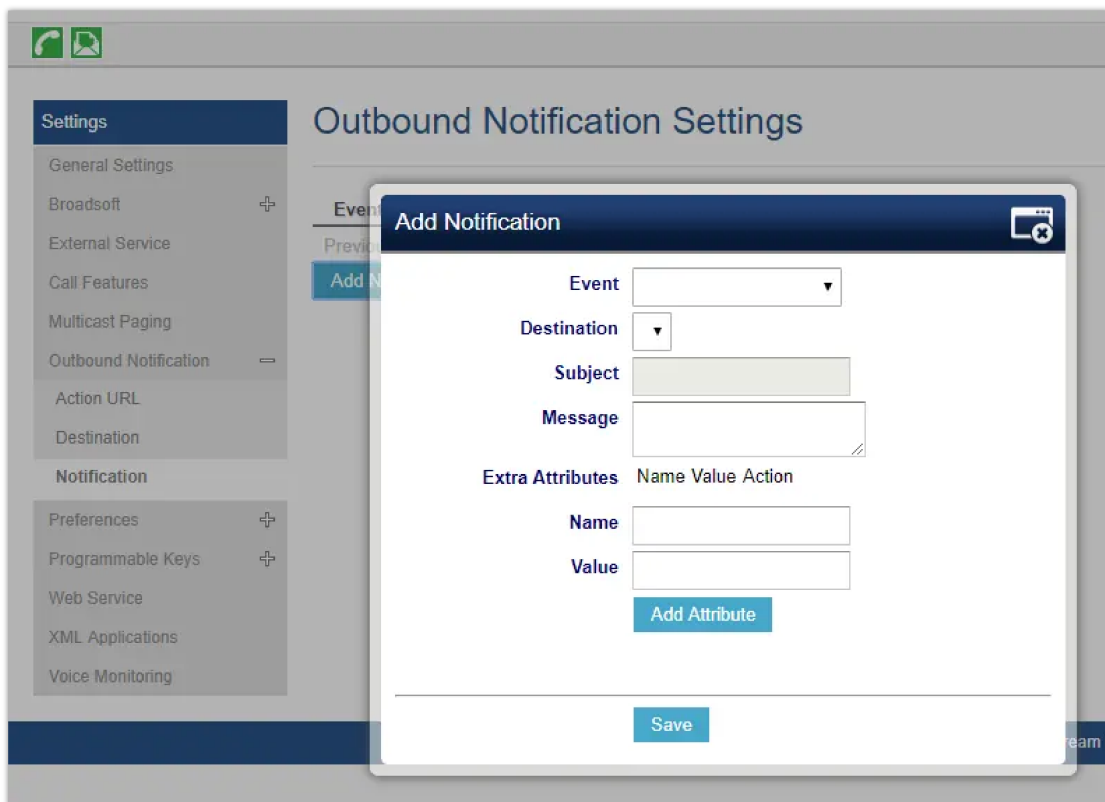

Action URL – Add Notification

Notification Option	Description
Event	Configures the event, which will trigger an outbound notification.

Destination	Configures the name of the destination where the outbound notification will be sent to.
Subject	Configures the subject of Email notification. This option is only applicable to SMTP protocol and it is not editable for other protocols.
Message	Configures the message body or the outbound notification.
Extra Attribute Name	Configure extra attribute's name reserved for specific attributes for a given notification in the future.
Extra Attribute Value	Configures extra attribute's value reserved for specific attributes for a given notification in the future.

Action URL – Notifications Option

The message body of the notification for each event can be customized with dynamic attributes embedded. The following table shows the mapping between the event and dynamic attributes.

Event	Dynamic Attribute Name	Dynamic Attribute Description
Call_Missed	line	line
	account	Account number associated with the call
	remoteNumber	The remote party number
	remoteName	The remote party name
	localNumber	The local party number
	localName	The local party name
	sipServer	The SIP server address of the account
	call-id	The SIP dialog call ID
	time	The time stamp when the missed call event occurs
DND	status	This is for DND status. The value can be “enabled” or “disabled”
Call_Forward	callType	This is for the type of the call. The value can be “incoming” or “outgoing”
	line	Line number associated with the call
	account	Account number associated with the call
	remoteNumber	The remote party number
	remoteName	The remote party name
	localNumber	The local party number
	localName	The local party name

	sipServer	The SIP server address of the account
	call-id	The SIP dialog call ID
	time	The timestamp when the call is forwarded
	fwNumber	Call Forward destination number
	fwReason	Call Forward reason
OAM_Login	OAMUser	OAM user name such as "admin"
	OAMLoginSource	OAM login source. The value can be "SSH" or "WebGUI"
	OAMLoginFromIP	OAM login From IP address. The value is the IP address of the PC who will log in phone's web UI or SSH
	OAMLoginCode	OAM login From IP address. The value is the IP address of the PC who will log in phone's web UI or SSH
	time	OAM login time stamp
OAM_Lockout	OAMUser	OAM user name such as "admin"
	OAMLoginSource	OAM login source. The value can be "SSH" or "WebGUI"
	OAMLoginFromIP	OAM login From IP address. The value is the IP address of the PC who will log in phone's web UI or SSH
	OAMLockoutCode	OAM lockout result code. The value can be "locked" or "unlocked"
	OAMLockoutTime	OAM lockout time stamp
Incoming_Call	callingNumber	Calling party number
	callType	Type of the call. The value can be "incoming" or "outgoing"
	line	Line number associated with the call
	account	Account number associated with the call
	remoteNumber	The remote party number
	remoteName	The remote party name
	localNumber	The local party number
	localName	The local party name
	sipServer	The SIP server address of the account
	call-id	The SIP dialog call ID
	time	The time stamp when the incoming call event occurs

Outgoing_Call	callType	Type of the call. The value can be “incoming” or “outgoing”
	line	Line number associated with the call
	account	Account number associated with the call
	remoteNumber	The remote party number
	remoteName	The remote party name
	localNumber	The local party number
	localName	The local party name
	sipServer	The SIP server address of the account
	time	The time stamp when the outgoing call event occurs
Call_Established	callType	Type of the call. The value can be “incoming” or “outgoing”
	line	Line number associated with the call
	account	Account number associated with the call
	remoteNumber	The remote party number
	remoteName	The remote party name
	localNumber	The local party number
	localName	The local party name
	sipServer	The SIP server address of the account
	call-id	The SIP dialog call ID
	startTime	The time stamp when outgoing call event occurs
Call_Terminated	callType	Type of the call. The value can be “incoming” or “outgoing”
	line	Line number associated with the call
	account	Account number associated with the call
	remoteNumber	The remote party number
	remoteName	The remote party name
	localNumber	The local party number
	localName	The local party name
	sipServer	The SIP server address of the account

	call-id	The SIP dialog call ID
	startTime	The time stamp when the call is established
Call_Forward_Status	duration	The call duration
	account	The account number associated with the call forward status change
	forwardNumberAll	The forward number for Call Forward All
	forwardNumberBusy	The forward number for Call Forward Busy
	forwardNumberNoAns	The forward number for Call Forward No Answer
Call Hold	callType	Type of the call. The value can be “incoming” or “outgoing”
	line	Line number associated with the call
	account	Account number associated with the call
	remoteNumber	The remote party number
	remoteName	The remote party name
	localNumber	The local party number
	localName	The local party name
	sipServer	The SIP server address of the account
	call-id	The SIP dialog call ID
	startTime	The time stamp when the call is on hold
Call_Resume	callType	Type of the call. The value can be “incoming” or “outgoing”
	line	Line number associated with the call
	account	Account number associated with the call
	remoteNumber	The remote party number
	remoteName	The remote party name
	localNumber	The local party number
	localName	The local party name
	sipServer	The SIP server address of the account
	call-id	The SIP dialog call ID
	startTime	The time stamp when the call is resumed

Blind_Transfer	line	Line number associated with the call
	account	Account number associated with the call
	remoteNumber	The remote party number
	remoteName	The remote party name
	localNumber	The local party number
	localName	The local party name
	sipServer	The SIP server address of the account
	call-id	The SIP dialog call ID
	time	The time stamp when the call is transferred
	transferName	Transferred party name
	transferNumber	Transferred party number
Transferred party number	Line	Line number associated with the call
	account	Account number associated with the call
	remoteNumber	The remote party number
	remoteName	The remote party name
	localNumber	The local party number
	localName	The local party name
	sipServer	The SIP server address of the account
	call-id	The SIP dialog call ID
	Time	The time stamp when the call is transferred
	transferName	Transferred party name
	transferNumber	Transferred party number
Register_Status	registerStatus	Account register status. The value can be “registered” or “unregistered”
Bootup_Complete	N/A	N/A
The dynamic attributes in this row are common attributes that can be applied to all events	mac	MAC address of the phone
	phone_ip	IP address of the phone
	program_version	Software version of the phone

	hardware_version	Hardware version of the phone
	product	Product name of the phone
	language	Display language on the phone

Action URL – Events and Dynamic Attributes

All the above dynamic attributes' value is generated by the phone system and can be used as dynamic attributes with a pair of curved braces around them. For example, if the message body is specified as follows:

Your call from {remoteName}:{remoteNumber} to {localName}:{localNumber} was forwarded to {fwdNumber} by reason {fwdReason}.

Then the message received in the outbound notification will look like this:

Your call from Daniel:2070 to Jasmine:2071 was forwarded to 777777 by reason unconditional.

Only attributes in curved braces will be replaced by the run-time value. Other content will remain the same as static text.

For each event, at most 3 notifications can be configured. In total, up to 75 notifications can be configured. The P-value for each notification is listed in the below table.

P Value	Notification	Value Format
P9920	Notification 1	String. Each P value consists of all the options configured for this notification. Example 1 – Notification 1 for event “Call_Missed” to destination 1, with 2 extra Attributes configured:P9920=eventName=Call_Missed&destName=destination1&subject=&msg=You have a missed call from {remoteName}:{remoteNumber} on Line {line}, account {account} at {time}.&extraAttrName1=extraAttrValue1&extraAttrName2=extraValue2 Example 2 – Notification 2 for event “Incoming_Call” to destination 2, with 2 extra Attributes configured: P9921=eventName=Incoming_Call&destName=destination2&subject=Incoming Call Alert&msg=You have an {callType} call from {remoteName}{remoteNumber} on Line {line}, account {account} at {time}.&extraAttrName1=extraAttrValue1&extraAttrName2=extraAttrValue2
P9921	Notification 2	
P9922	Notification 3	
P9923	Notification 4	
P9924	Notification 5	
P9925	Notification 6	
P9926	Notification 7	
P9927	Notification 8	
P9928 P9929 ... P9993 P9994	Notification 9 Notification 10 ... Notification 73 Notification 74	The BOLD strings in above examples are the actual values configured in each field for the notification.
P9995	Notification 75	

Action URL Notification P-values

UPGRADING AND PROVISIONING

Unified Firmware

The GRP2610 / GRP2610P / GRP2611G / GRP2612 / GRP2612P / GRP2612W / GRP2613 / GRP2614 / GRP2615 / GRP2616 / GRP2624 / GRP2634 / GRP2670 / GRP2650 support unified firmware for all GRP261X/GRP2624/GRP263x/GRP2670/GRP2650 models.

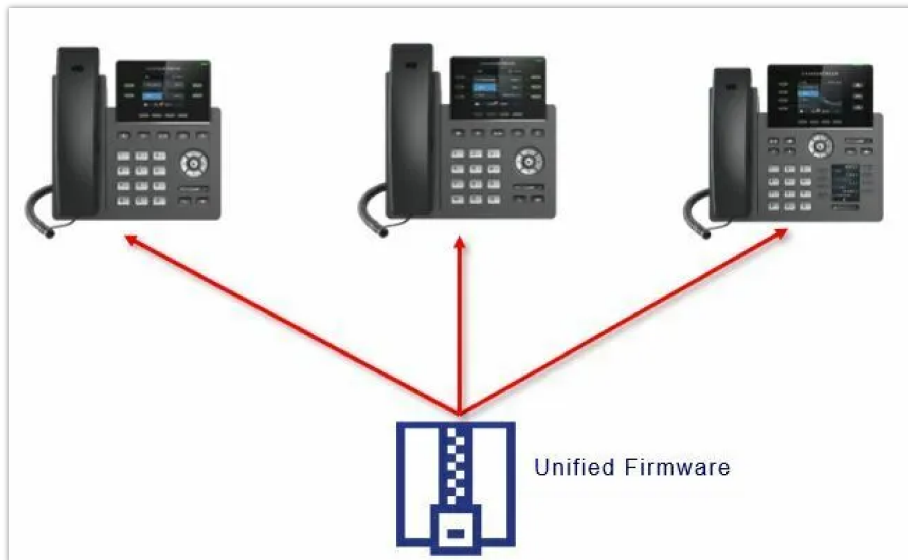

GRP261X/GRP2624/GRP2634/GRP2670/GRP2650 Unified Firmware

Dual-image Firmware

The GRP261X/GRP2624/GRP263x/GRP2670/GRP2650 series support dual-image firmware allowing the storage of two copies of firmware on flash to avoid bricked device on unsuccessful upgrades and downtime.

The user can roll back to previously loaded firmware from the phone's **Menu → System → Alternative Firmware**, and press "Rollback".

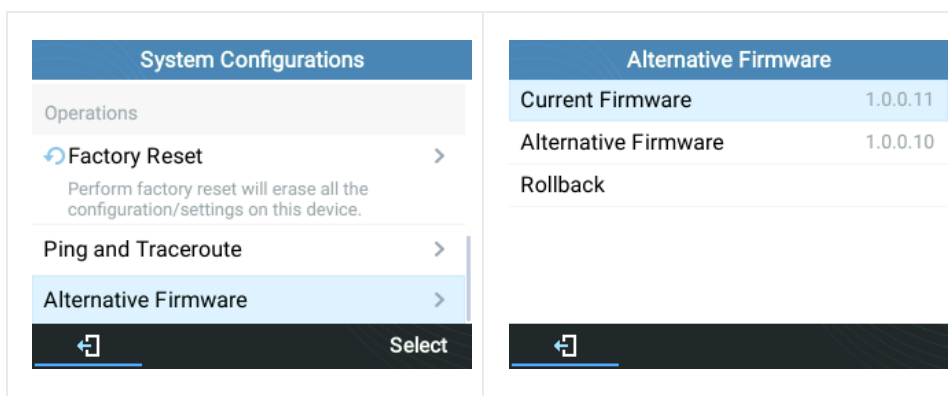

Alternative Firmware – Rollback

Firmware Upgrade

The GRP261X/GRP2624/GRP263x/GRP2670/GRP2650 series can be upgraded via TFTP / FTP / FTPS / HTTP / HTTPS by configuring the URL/IP Address for the TFTP / HTTP / HTTPS / FTP / FTPS server and selecting a download method. Configure a valid URL for TFTP, FTP/FTPS or HTTP/HTTPS, the server name can be FQDN or IP address.

Examples of valid URLs:

firmware.grandstream.com/BETA

fw.mycompany.com

There are two ways to set up a software upgrade server: The LCD Keypad Menu or the Web Configuration Interface.

Upgrade via Keypad Menu

Follow the steps below to configure the upgrade server path via the phone's keypad menu:

1. Press the MENU button and navigate using the Up/Down arrow to select System.
2. In the System options, select Upgrade.
3. Enter the firmware server path and select the upgrade method. The server path could be in IP address format or FQDN format.
4. Select the **Start Provision** option and press the "Select" Softkey.
5. A warning window will be prompted for provision confirmation. Press the "YES" Softkey to start upgrading/provisioning immediately.

When upgrading starts, the screen will show the upgrading progress. When done you will see the phone restarts again. Please do not interrupt or power cycle the phone when the upgrading process is on.

Upgrade via Web GUI

Open a web browser on a PC and enter the IP address of the phone. Then, log in with the administrator username and password. Go to Maintenance→Upgrade and Provisioning page, enter the IP address or the FQDN for the upgrade server in the "Firmware Server Path" field, and choose to upgrade via TFTP or HTTP/HTTPS, or FTP/FTPS. Update the change by clicking the "Save and Apply" button. Then "Reboot" or power cycle the phone to update the new firmware.

When upgrading starts, the screen will show the upgrading progress. When done you will see the phone restart again. Please do not interrupt or power cycle the phone when the upgrading process is on.

Firmware upgrading takes around 60 seconds in a controlled LAN or 5-10 minutes over the Internet. We recommend completing firmware upgrades in a controlled LAN environment whenever possible.

Note

From the top right corner of the Web UI, you can start the Provision process for both firmware and config files by clicking on the Provision icon . 

No Local TFTP/FTP/HTTP Servers

For users that would like to use remote upgrading without a local TFTP/FTP/HTTP server, Grandstream offers a NAT-friendly HTTP server. This enables users to download the latest software upgrades for their phones via this server. Please refer to the webpage:

<https://www.grandstream.com/support/firmware>

Alternatively, users can download a free TFTP, FTP, or HTTP server and conduct a local firmware upgrade. A free window version TFTP server is available for download from:

http://www.solarwinds.com/products/freetools/free_tftp_server.aspx

<http://tftpd32.jounin.net/>.

Instructions for local firmware upgrade via TFTP:

1. Unzip the firmware files and put all of them in the root directory of the TFTP server.
2. Connect the PC running the TFTP server and the phone to the same LAN segment.
3. Launch the TFTP server and go to the File menu→Configure→Security to change the TFTP server's default setting from "Receive Only" to "Transmit Only" for the firmware upgrade.
4. Start the TFTP server and configure TFTP server in the phone's web configuration interface.

5. Configure the Firmware Server Path to the IP address of the PC.
6. Update the changes and reboot the phone.

End users can also choose to download a free HTTP server from <http://httpd.apache.org/> or use Microsoft IIS web server.

Phone Provisioning

Configuration File Download

Grandstream SIP devices offer flexible configuration options through both the web interface and configuration files. The system supports different provisioning methods, including the ability to process multiple custom configuration files.

Devices can be configured via:

- Web interface
- Configuration files (binary or XML format) using:
 - TFTP
 - FTP/FTPS
 - HTTP/HTTPS
 - HTTPS (secure)

The "Config Server Path" is the TFTP, FTP/FTPS, or HTTP/HTTPS server path for the configuration file. It needs to be set to a valid URL, either an FQDN or IP address format. The "Config Server Path" can be the same or different from the "Firmware Server Path".

Configuration Parameters (P-values and Aliases)

Each web interface field corresponds to a configuration parameter using the formats:

- **P** followed by 2-5 digits (e.g., **P2** for Admin Password)
- Intuitive names that match web UI field names for easier management (e.g., `users.admin.password` = Admin Password)
- For complete parameter mapping, refer to the configuration template which can be downloaded from [Grandstream tools](#).

Note:

P-values need to be placed between lines that begin with a '#' to be able to be provisioned. Lines that start with a '#' have their data ignored so they can be used as comments.

Example configurations:

The following configurations are examples for enabling SSH access on the phone.

- **XML Format (using alias):**

```
<?xml version="1.0" encoding="UTF-8"?>
<gs_provision version="1">
  <config version="2">
    <item name="security.ssh">Yes</item>
  </config>
</gs_provision>
```

- **Binary Format (using P-values):**

```
#  
P276=1  
#
```

Configuration File Hierarchy

When booting or rebooting, GRP261X/GRP2624/GRP263x/GRP2670/GRP2650 phones follow this sequence to locate configuration files:

When booting or rebooting, GRP26XX series phones follow this sequence to locate configuration files:

1. **Primary MAC-specific XML:** `cfgxxxxxxxxxxxx.xml` (where `xxxxxxxxxxxx` is the device's 12-digit MAC address)
2. **MAC-specific binary fallback:** `cfgxxxxxxxxxxxx` (same MAC address without file extension)
3. **Model-specific configuration:** `cfg<model>.xml` (where `<model>` is the phone model, e.g., `cfggrp2613.xml`)
4. **Global configuration file:** `cfg.xml` (applies to all devices if present)
5. **Legacy binary configuration:** `dev[MacAddress].cfg` (using the device MAC address format)
6. **External configuration reference (New):** `external.cfg` (contains paths to multiple configuration files, please refer to [this section](#) for more information)



```
Info  
1 GET /cfgc074ad4bd09f.xml HTTP/1.1  
2 GET /cfgc074ad4bd09f HTTP/1.1  
3 GET /cfggrp2634.xml HTTP/1.1  
4 GET /cfg.xml HTTP/1.1  
5 GET /devc074ad4bd09f.cfg HTTP/1.1  
6 GET /external.cfg HTTP/1.1
```

Provisioning File Sequence

Note: (attempt to download the config file again)

When doing provision on the phone, if your first config file contains p-values listed below, phone will try to download the potential second `cfg.xml` file and apply the second file without rebooting. Maximum 3 extra attempts.

Those P-values are:

- *212 -- Config upgrade via
- *234 -- Config prefix
- *235 -- Config postfix
- *237 -- Config upgrade Server
- *240 - Authenticate Config File
- *1359 - XML Config File Password
- *8463 - Validate Server Certificate
- *8467 - Download and process ALL Available Config Files
- *20713 - Always authenticate before challenge
- *22011 - Bypass Proxy For
- *22030 - Enable SSL host verification for provision

Note: (P-Values that trigger auto-provision)

If the p-values listed below are changed while managing configuration on web UI or LCD, the provision process will be triggered:

- *192 -- Firmware upgrade server
- *232 -- Firmware prefix
- *233 -- Firmware postfix
- *6767 -- Firmware Upgrade Via
- *6768 -- Firmware HTTP/HTTPS Username
- *6769 -- Firmware HTTP/HTTPS Password
- *237 -- Config upgrade Server
- *212 -- Config upgrade via
- *234 -- Config prefix
- *235 -- Config postfix
- *1360 -- Config HTTP/HTTPS username
- *1361 -- Config HTTP/HTTPS password.

Note: (Certificates and keys provisioning)

Users can configure the phone to get all the needed certificates during boot up. Instead of putting the certificate/key content in the text directly from the Web interface or uploading them manually, they can choose to provision them from the configuration file by putting the URL in the P-value field of each certificate and/or key. (e.g. http://ProvisionServer_address/SIP-TLS-Certificate.pem) The phone will then process the URL, search for the appropriate certificate/Key file, download it and then apply it to the phone.

```
HTTP GET /SIP-TLS-Private-Key.key HTTP/1.1
HTTP HTTP/1.1 200 OK (application/octet-stream)
HTTP GET /SIP-TLS-Certificate.pem HTTP/1.1
HTTP HTTP/1.1 200 OK (application/octet-stream)
HTTP GET /Trusted-certificate-1.crt HTTP/1.1
HTTP HTTP/1.1 200 OK (application/octet-stream)
HTTP GET /Trusted-certificate-2.crt HTTP/1.1
HTTP HTTP/1.1 200 OK (application/octet-stream)
HTTP GET /Trusted-certificate-3.crt HTTP/1.1
HTTP HTTP/1.1 200 OK (application/octet-stream)
HTTP GET /Trusted-certificate-4.crt HTTP/1.1
HTTP HTTP/1.1 200 OK (application/octet-stream)
HTTP GET /Trusted-certificate-5.crt HTTP/1.1
HTTP HTTP/1.1 200 OK (application/octet-stream)
HTTP GET /Trusted-certificate-6.crt HTTP/1.1
HTTP HTTP/1.1 200 OK (application/octet-stream)
HTTP GET /OpenVPN-CA.crt HTTP/1.1
HTTP HTTP/1.1 200 OK (application/octet-stream)
HTTP GET /OpenVPN-Certificate.pem HTTP/1.1
HTTP HTTP/1.1 200 OK (application/octet-stream)
HTTP GET /OpenVPN-Key.key HTTP/1.1
HTTP HTTP/1.1 200 OK (application/octet-stream)
```

Certificates Files Download

Note: (Force reboot after provisioning).

To force a reboot after provisioning, users could include the reboot p-value (22421) set to 1 and the downloaded config file includes any change.

For more details on XML provisioning, please refer to:

[SIP Device Provisioning Guide](#)

Multiple Custom Config Files

The GRP261x series now supports the ability to load multiple custom configuration files during the provisioning process. This feature provides greater flexibility in managing device configurations, especially in environments where different settings need to be sourced from multiple locations.

Notes:

- The phone can process an external file (**external.cfg**) that contains a list of additional configuration files to be downloaded and applied.
- The external file can include paths to configuration files hosted on different servers (e.g., **TFTP, HTTP, HTTPS**).
- Paths in the external file can use variables like **\$MAC** (device MAC address) and **\$PN** (product model) for dynamic file naming.
- The external file can list multiple configuration files separated by commas (,) or newline characters (**\n** or **\r\n**).
- Settings in later configuration files override those in earlier files, allowing for layered customization.

The configuration steps are described below:

1. Ensure the phone's firmware version is 1.0.13.21 or higher.
2. Prepare an **external.cfg** file with the paths to additional configuration files. For example:

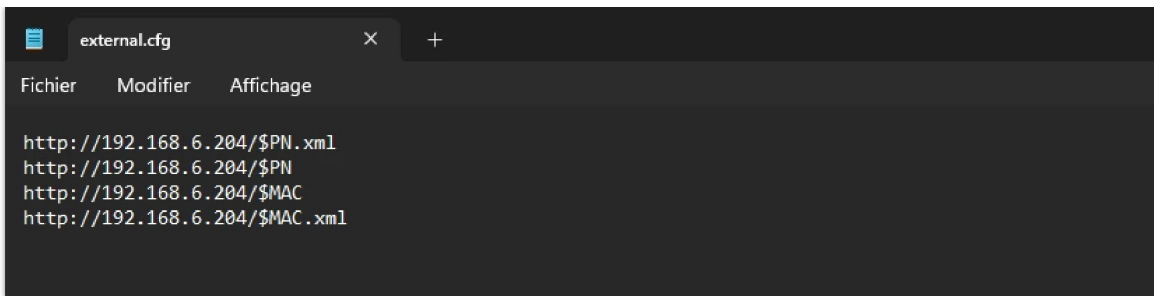

External.cfg file

3. Place **external.cfg** on the provisioning server (e.g., TFTP, HTTP) and ensure it is accessible to the phone.

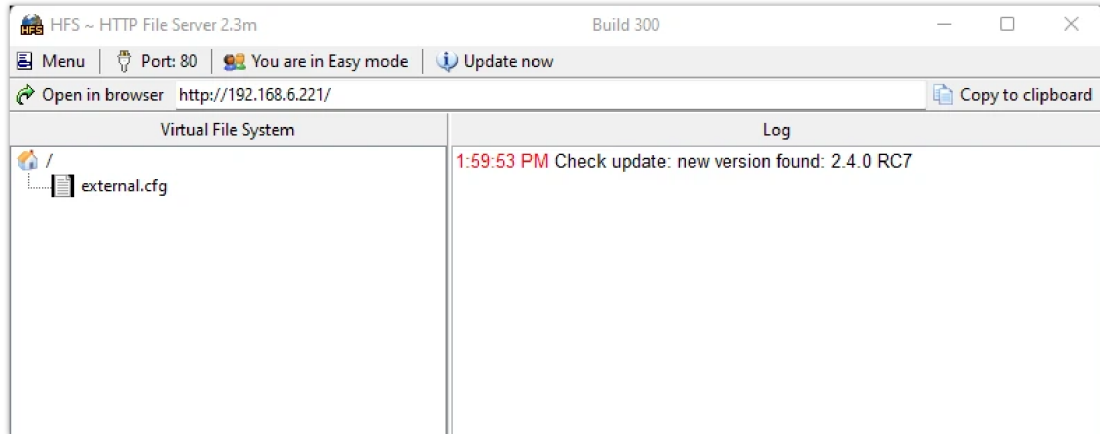

HTTP Server with external.cfg File

4. Set the “**Config Server Path**” in the phone’s web GUI or provisioning template to point to the **external.cfg** file.

5. Select the appropriate “**Config Upgrade Via method**” (e.g., TFTP, HTTP) based on where the external file is hosted.

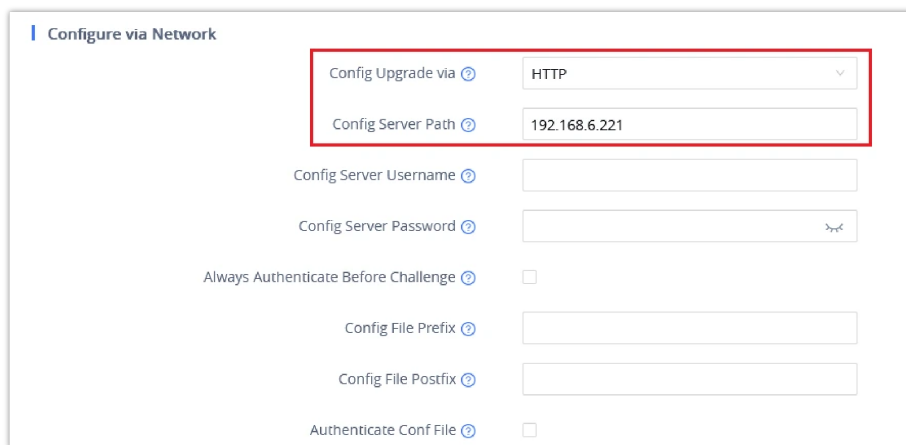

GRP261x Upgrade and Provisioning Settings

6. The phone will download and process the **external.cfg** file, then sequentially apply the configurations listed in it.

```

HTTP      GET /external.cfg HTTP/1.1
HTTP      HTTP/1.1 200 OK
HTTP      GET /GRP2634.xml HTTP/1.1
HTTP      HTTP/1.1 200 OK
HTTP      GET /GRP2634 HTTP/1.1
HTTP      HTTP/1.1 200 OK
HTTP      GET /c074ad4bd09f HTTP/1.1
HTTP      HTTP/1.1 200 OK

```

Configuration Files Download

No Touch Provisioning

After the phone sends, the config file request to the Broadsoft provisioning server via HTTP/HTTPS, if the provisioning server responds "401 Unauthorized" asking for authentication, the phone's LCD will prompt a window for the user to enter username and password. Once the correct username and password are entered, the phone will send the config file requests again with authentication. Then the phone will receive the config file to download and get provisioned automatically.

Besides manually entering the username and password in the LCD prompt, users can save the login credentials for the provisioning process as well. The username and password configuration is under the phone's web UI→Maintenance→Upgrade and provisioning page: "HTTP/HTTPS Username" and "HTTP/HTTPS Password". If the saved username and password saved are correct, the login window will be skipped. Otherwise, the login window will be popped up to prompt users to enter the correct username and password again.

Shortcut of Upgrade and Provision via Keypad Menu

When the GRP phone is in an idle state, the user could press the HOLD key and RIGHT navigation key together to trigger provision functions. Similarly, the phone will pop up a reboot banner while idle, if the user presses the HOLD key and LEFT navigation key together. After the provision or reboot banner pops up on the LCD screen, the user could press YES/NO Softkey to confirm/cancel the action.

GRP261X/GRP2624/GRP263x/GRP2670/GRP2650 TOOLS

From the web GUI under Maintenance → Tools, 4 tools are provided:

Provision: This makes the phone trigger instant provisioning.

Factory reset: Sets back the phone to the factory default settings.

Warning

Restoring the Factory Default Settings will delete all configuration information on the phone. Please backup or print all the settings before you restore to the factory default settings. Grandstream is not responsible for restoring lost parameters and cannot connect your device to your VoIP service provider.

Ping: Makes the phone ping an URL to check if it has access to it.

Traceroute: Checks the route packets taken to the specified URL.

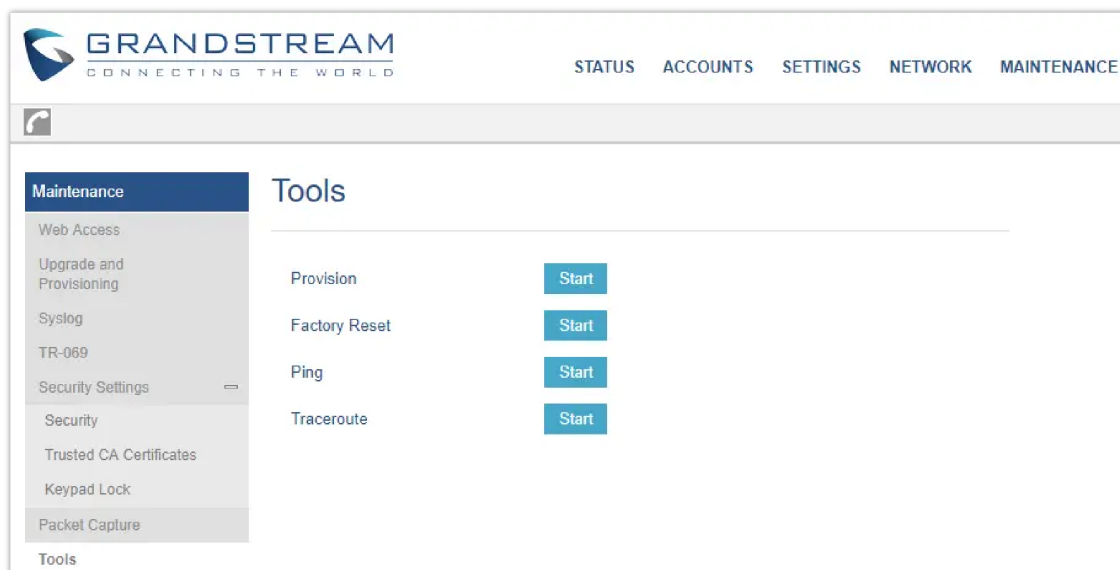

GRP261X/GRP2624/GRP2634 Tools

RESTORE FACTORY DEFAULT SETTINGS

Warning

Restoring the Factory Default Settings will delete all configuration information on the phone. Please backup or print all the settings before you restore to the factory default settings. Grandstream is not responsible for restoring lost parameters and cannot connect your device to your VoIP service provider.

Restore Factory Settings Using the LCD Menu

Please follow the instructions below to reset the phone:

1. Press the MENU button to bring up the keypad configuration menu.
2. Select "System" and enter.
3. Select "Operations – Factory Reset".
4. A warning window will pop out to make sure a reset is requested and confirmed.

Press the "Yes" Softkey to confirm and the phone will reboot, or "No" Softkey to cancel the Reset.

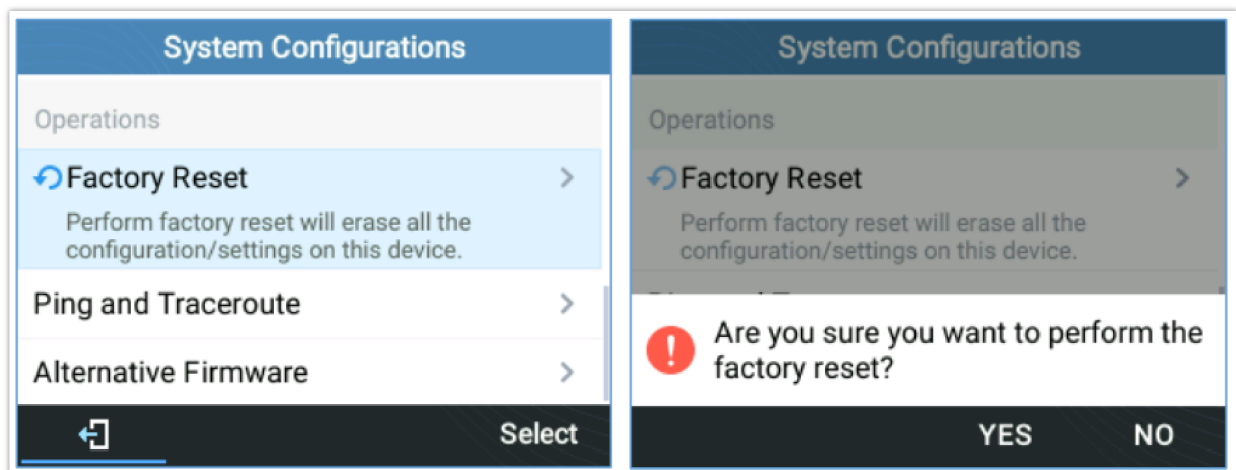

Factory Reset using LCD Menu

Restore Factory Settings Using the Keypad

Please follow the instructions below to reset the phone using the keypad:

1. While the device is booting, press and hold the **1 + 9** keys on the keypad.
2. The LCD will display a recovery menu with two options:
 - o **Factory Reset:** Restore all settings to defaults.
 - o **Rollback Firmware:** Revert to the last installed alternative firmware.
3. Use the **up/down arrow keys** to highlight your choice, then press the **Submit softkey** button to confirm.

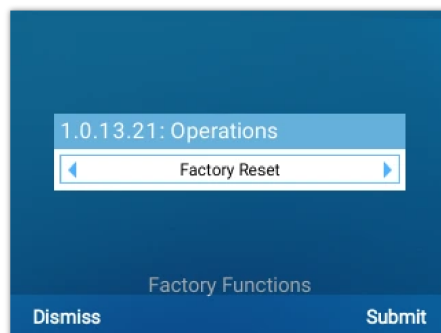

Factory Reset

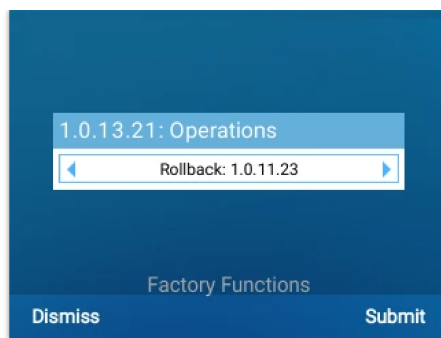

Rollback to Alternative Firmware

CHANGE LOG

This section documents significant changes from previous versions of user manuals for GRP261x/GRP2624/GRP263x/GRP2670/GRP2650. Only major new features or major document updates are listed here. Minor updates for corrections or editing are not documented here.

Firmware version 1.0.13.21

- Added support for downloading multiple custom config files in succession. [[Multiple Custom Config Files](#)]
- Added support for customizing early media response. [[Use P-Early-Media Header](#)][[Ringback Tone at No Early Media](#)]
- Added support for filtering characters out of outbound numbers. [[Filter Characters](#)]
- Added support for LDAP type Conference. [[LDAP](#)]
- Added support for phone type "Conference" in XML phonebook. [[Download XML Phonebook](#)]
- Added support for multiple XMLApp launch points where each launch point can be configured to use a different XMLApp server path. [[Enable XML Application Auto Launch](#)]
- Added support for token definitions under XMLApp server path configurations. [[XML Application](#)]
- Added support for the "ShowLabel" softkey so you can see the complete VPK label during calls. [[Show Keys Label](#)]
- Added support for printing MPK label cards from the Web UI. [[Print](#)]
- Added support for rolling back to alternative firmware when booting up by holding the 1+9 keys. [[Rollback Firmware](#)]
- Added support for a configurable station name label. [[Customized Station Label](#)]
- Added support for PTT (Push-to-talk). [[Enable Push-To-Talk](#)]
- Added support for OpenVPN® Client Key Password. [[OpenVPN® Client Key Password](#)]
- Added support for OpenVPN® failover. [[OpenVPN® Server Secondary Address](#)][[OpenVPN® Secondary Port](#)][[Randomly Select Server](#)]
- Added support for scheduled tasks. [[Scheduled Tasks](#)]
- Added support for certificate uploading for WPA-EAP TLS method. [[CA Certificate](#)][[Client Certificate](#)]
- Added support for using contact names even if the number only partially matches. [[Enable Partial Contact Number Lookup](#)][[Minimum partial match length](#)][[Maximum partial match length](#)]
- Added predictive dialing support for LDAP directory. [[Predictive Dialing Source](#)]
- Added support for hiding specific or all pop-ups. [[Hide Pop-up Options](#)]
- Added support for SIP URI. [[Add Contact](#)]
- Added support for multicast call timeout. [[Multicast Call Timeout\(s\)](#)]
- Added support for DNS SRV mode for LDAP server lookup. [[LDAP DNS Mode](#)]
- Added support for hiding remote user ID by digit plan. [[Hidden Number Features](#)][[Hidden Number Plan List](#)][[Hidden Number Plan Test](#)]
- Added support for disabling the headset key. [[Headset Key Mode](#)]
- Added the "GDS Opendoor" softkey to the call screen softkeys list in Custom Softkey Layout. [[Custom Softkey Layout](#)]
- Added support for the Transfer to VM feature code. [[Transfer to VM feature code](#)]
- Added support for Enhanced Call Park. [[Enable Call Park Softkey](#)]

- Wallpaper tool-tip now displays the recommended dimensions for the model in use. [[Upload Wallpaper](#)]
- Added support for hiding Bluetooth and WiFi settings from LCD and WebU. [[Wi-Fi Settings](#)][[Bluetooth Settings](#)]
- Added support for controlling DTMF Tone Gain. [[DTMF Tone Gain](#)]
- Added support for configuring different settings for each Wi-Fi SSID via pvalue/alias. [[ESSID](#)]
- Increased maximum number of SIP accounts of GRP2614/GRP2624/GRP2634 to 12 accounts and GRP2615/GRP2616/GRP2636/GRP2650/GRP2670 to 16 accounts. [[Account Status](#)] [[Technical Specifications](#)]
- Added support for provisioned ringtone soft reset. [[Total Number of Custom Ringtone Update](#)]
- Added a "Login from LCD" button when accessing the Web GUI. [[Accessing the Web UI via LCD](#)]
- Added support for remote access to Web UI via GDMS for firmwares 1.0.13.20+. [[Remote Access to Web UI through GDMS](#)]

Firmware version 1.0.11.23

- Added support for RFC3164 compliant Syslog header format. [[Syslog Header Format](#)]
- Added support for a management interface. [[Management Interface](#)]
- Adjusted Static DNS behavior to attempt to retrieve latest result from DNS server before using static value. [[Static DNS Cache](#)]

Firmware version 1.0.11.18

- Increased the maximum number of SIP accounts for GRP2614 and GRP2615 to 6 accounts. [[Account Status](#)] [[Technical Specifications](#)]

Firmware version 1.0.11.15

- Added ability to configure a timeout to return to the first page of VPKs. [[VPK Paging Auto Return Timeout](#)]
- Increased maximum number of SIP accounts for the GRP2612, GRP2613 to 4 SIP accounts and GRP2624, GRP2634 to 6 SIP accounts (with the exception of legacy hardware discontinued after 2020). [[Account Status](#)] [[Technical Specifications](#)]
- Disabled User Web Access by default. [[Enable User Web Access](#)]

Firmware version 1.0.9.141

- Added the ability to configure the Alert-Info Remote Ringtone Download Timeout. [[REMOTE RINGTONE DOWNLOAD TIMEOUT](#)]
- Added visual indicators to reflect changes in presence status. [[PRESENCE LED](#)]

Firmware version 1.0.9.136

- Added support for authentication on XMP apps. [[XML authentication](#)]
- Added ability to disable playing the local in-call DTMF tone when using speakers. [[DTMF TONE WHEN USING SPEAKERS](#)]

Firmware version 1.0.9.132

- Added ability to display Serial Number on the Web UI. [[Serial Number](#)]
- Added a new VPK/MPK mode called "Silent Call". [[Silent Call](#)]
- Added a new VPK/MPK called "HTTP Command" . [[HTTP Command](#)]
- Added support for USB MPK keys on Hardware version 2 phones (HW V2). [[USB MPK](#)]
- Added ability to configure connected GBX20's font size. [[Font Size on Extension Board](#)]
- Added ability to configure VQ reports to be sent to the same address used for SIP REGISTER. [[Collector Address Selection](#)]
- Added ability to automatically record calls locally. [[Local Call Recording Feature](#)]
- Improved local call recording filename to be more useful. [[Download Local Call Recordings](#)]
- Added ability to configure static NAPTR/SRV/A records. [[Static DNS Records](#)]
- Supported provisioning alias config parameters to be non-case sensitive. [[Download Device Configuration](#)]
- Added ability to have syslog settings and internal logs be saved after a factory reset. [[Syslog Protocol](#)]

- Changed DNS SRV Fail-over Mode option 3 alias name so that it matches the GRP260x version. [[Failback follows failback expiration timer](#)]

Firmware version 1.0.9.103

- No Major Changes.

Firmware version 1.0.9.99

- Added support for including the upgrade method in the firmware/config server path. [[Config Server Path](#)] [[Firmware Server Path](#)]
- Added support for playing remote ringtones via Alert-Info. [[Match Incoming Caller ID](#)]
- Added support for FTP for downloading phonebook XML. [[Enable Phonebook XML Download](#)]
- Added support for a trusted domain name list. [[TRUSTED DOMAIN NAME LIST](#)]
- Added a prompt that displays when recording file storage is getting close to full. [[Local Call Recording Feature](#)]
- Added ability to disable the call recording indicator on LCD when a recording is started by the other party [[ENABLE CALL RECORDING LCD INDICATOR](#)]
- Added support for increasing RTP jitter buffer target delay. [[JITTER BUFFER TARGET DELAY](#)]

Firmware version 1.0.9.83

- Changed DHCP options 150/160/161 to all be enabled by default [[DHCP 150/160/161](#)]
- Added support for EAP-PEAP with Microsoft servers. [[802.1x Mode](#)]
- The "Release DHCP On Reboot" setting was changed to "No" by default. [[Release DHCP On Reboot](#)]
- Added the ability to connect to the pre-configured default SSID "wp_master" on Wi-Fi-supported models [[Auto-Connection](#)]
- Added provision button on the top right corner of Web UI. [[UPGRADING AND PROVISIONING](#)]
- Added ability to configure default input method for Contacts and LDAP. [[DEFAULT INPUT METHOD](#)]

Firmware version 1.0.9.74

- Added the Energy Saving Feature. [[Energy Saving](#)]
- Added Energy Saving Status Information. [[Status Page Definitions](#)]
- Added a separate Programmable keys configuration section. [[Programmable Keys Page Definitions](#)]
- Added a separate System settings configuration section. [[System Settings page Definitions](#)]
- Added a separate Application settings configuration section. [[Application Page Definitions](#)]
- Added a separate external service settings configuration section. [[External Services Page Definition](#)]
- Added ability to define input fields in XML applications. [[Application Page Definitions](#)]
- Added ability to reboot and provision to XML applications. [[Application Page Definitions](#)]
- Added ability for voicemail VPK to dial into target's mailbox. [[Monitored Voicemail Access Number](#)]
- Added ability to configure X-switch-info SIP header. [[X-Switch-Info](#)]
- The system Information page will now display the VPN IP address. [[Status Page Definition](#)]
- Added a WebUI option to enable/disable SIP intercom. [[Enable Paging Call Mode](#)]
- Added option to set a timeout for Public Mode. [[Login Timeout](#)]
- Added ability to configure whether the phone will release DHCP lease on reboot. [[Release DHCP On Reboot](#)]
- Added HAC support for v2 phones [[HAC](#)]

Firmware version 1.0.9.22

- Added support for GRP2650.
- Modernized the look of the Web UI.

Firmware Version 1.0.7.33

- Added ability to send P-Asserted-Identify header on SIP INVITE instead of P-Preferred-Identity. [[Account Page Definitions](#)]

Firmware Version 1.0.7.25

- Added the ability to also enable the speakerphone during a call when using either the handset or headset [[Settings Page Defintions](#)]
- Added support for distinctive ringtone based on alert-info string syntax match [[Account Page Definitions](#)]
- Added the ability to use special characters on the 802.1X MD5 password [[Network Page Definitions](#)]
- Added ability to configure multicast IGMP query interval [[Settings Page Definitions](#)]
- Added support for uploading .pem trusted CA certificate files [[Maintenance Page Defintions](#)]
- Added the user-agent field in action URL [[Outbound Notification Support](#)]

Firmware Version 1.0.7.23

- No major changes

Firmware Version 1.0.7.22

- Added ability to configure custom Call Park/Retrieve Feature Codes. [[Account Settings Page](#)]
- Added support for manually importing a single OpenVPN® configuration file. [[Network Page](#)]

Firmware Version 1.0.7.19

- Added E911 compliance and HELD protocol support [[Settings Page Definitions](#)]

Firmware Version 1.0.5.93

- Added support for GRP2670.
- Added ability to auto-answer pre-defined numbers [AUTO ANSWER NUMBERS]
- Added ability to log in/logout from all UCM queues in one click [[UCM CALL CENTER FAST LOGIN/LOGOUT](#)]
- Added support of the Contact Source Priority Feature [[CONTACT SOURCE PRIORITY](#)]
- "Blacklist/Whitelist" has been renamed to "Blocklist/Allowlist"

Firmware Version 1.0.5.67

- Added support to turn on the LED of VPK/MPK while the screensaver is being displayed on the screen. [[Use Programmable Keys in Screensaver](#)]
- Added support to replace duplicate items when downloading an XML phonebook [[Replace Duplicate Items](#)]
- Added support for up to 3 Remote Phonebooks [[Remote Phonebook](#)]
- Added support to use RFC3261 instead of RFC6665 for subscription refresh audio [[Use Route Set in NOTIFY](#)]
- Added support for RTCP port negotiation mode [[RTCP Port Selection](#)]
- Added support for Noise Shield for handset [[Handset Noise shield 2.0](#)]
- Added option BroadSoft Contacts Download Limit [[BS CONTACTS DOWNLOAD LIMIT](#)]
- Added option BroadSoft Contacts Search Limit [[BS CONTACTS SEARCH LIMIT](#)]
- Added option to Show/Hide VPK label on call screen [[Show Keys Label](#)]
- Added ability to allow users to use the other remaining SIP accounts in public mode [[Allow Multiple Accounts](#)]
- Added ability to force a reboot after provisioning if you include the reboot p-value (22421) set to 1 and the downloaded config file includes any change. [[Configuration File Download](#)]
- Added configurable option to perform a factory reset when "Configuration via Keypad Menu" isn't in Unrestricted mode [[FACTORY RESET SECURITY LEVEL](#)]
- Added more customization options for idle screen softkeys [[CUSTOMIZE IDLE SCREEN SOFTKEY](#)]

Firmware Version 1.0.5.48

- No major changes.
- This is the initial version for GRP261x/GRP2624/GRP2634.

Firmware Version 1.0.5.45

- No major changes.

Firmware Version 1.0.5.44

- No major changes.

Firmware Version 1.0.5.36

- Added support for a power-saving feature of turning off the LCD display automatically according to a configurable schedule. [[Office Hour](#)]
- Added support for a power-saving feature of turning off the LCD display automatically according to a timer when not during office hours. [[Power Saving Timeout](#)]
- Added support for using variables on the configuration server path. [[Config Server Path](#)][[Firmware Server Path](#)]

Firmware Version 1.0.5.33

- Added support for choosing between RTCP and RTCP-XR. [[Enable RTCP](#)]
- Added support for Blacklist/Whitelist IP addresses for web access. [[Web Access Control](#)]
- Added support for disabling the feature of selecting an account from LCD. [[Select account from LCD](#)]
- Added "Disable Active MPK Page" option for GRP2614/2616, before it only existed for GRP2615. [[Disable Active MPK Page](#)]
- Extended the amount of text that can be displayed on the Extension label. [[Use Long Label](#)]
- Allows use of Primary SIP server URI in REGISTER for both Primary and Secondary SIP servers

Firmware Version 1.0.5.15

- Added support to provision new config file "dev[MAC ADDRESS].cfg". [[Configuration File Download](#)]
- Added option to adjust Call Tone Volume. [[Call Tone Volume](#)]
- Added ability to enable EDRC feature. [[Headset Noise Shield 2.0](#)]
- Line status indicator on LCD will now show account name while VPK label on LCD will show VPK description. [[Virtual Multi-Purpose Keys](#)]
- Added GUV300x USB headset support.

Firmware Version 1.0.3.6

- Added support for exact match lookup method for LDAP search. [[Exact Match Search](#)]

Firmware Version 1.0.1.23

- Improved DNS SRV Failover Design for NetSapiens servers and other server types. [[Register Before DNS SRV Failover](#)]

Firmware Version 1.0.1.17

- Added the ability to add the MAC address to the User-Agent [[MAC in User-Agent](#)]
- Added support for Chile time zone. [[Time Zone](#)]
- Added support for new provision file. [[Configuration File Download](#)]

Firmware Version 1.0.1.7

- Added support for GRP2615.
- Added support for GRP2616.

Firmware Version 1.0.0.31

- Added Presence Event list mode to VPK/MPK modes. [[Presence EventList](#)]
- Added GDS DoorOpen mode to VPK/MPK modes. [[GDS DoorOpen](#)]
- Changed Screensaver Default value to "On if no VPK is active". [[Screensaver](#)]

Firmware Version 1.0.0.16

- This is the initial version for GRP261x.

EXPERIENCING GRP261X/GRP2624/GRP263x/GRP2670/GRP2650

Please visit our website: <https://www.grandstream.com> to receive the most up-to-date updates on firmware releases, additional features, FAQs, documentation, and news on new products.

We encourage you to browse our [product-related documentation](#), [FAQ](#), and [User and Developer Forum](#) for answers to your general questions. If you have purchased our products through a Grandstream Certified Partner or Reseller, please contact them directly for immediate support.

Our technical support staff is trained and ready to answer all your questions. Contact a technical support member or [submit a trouble ticket online](#) to receive in-depth support.

Thank you again for purchasing the Grandstream IP phone, it will be sure to bring convenience and color to both your business and personal life

Caution:

Changes or modifications to this product not expressly approved by Grandstream, or operation of this product in any way other than as detailed by this guide, could void your manufacturer warranty.

Warning:

Please do not use a different power adaptor with devices as it may cause damage to the products and void the manufacturer warranty.

GNU GPL Information

GRP261X/GRP2624/GRP2634/GRP2670/GRP2650 firmware contains third-party software licensed under the GNU General Public License (GPL). Grandstream uses software under the specific terms of the GPL. Please see the GNU General Public License (GPL) for the exact terms and conditions of the license.

Grandstream GNU GPL-related source code can be downloaded from the Grandstream website from:

https://www.grandstream.com/hubfs/Product_Documentation/GRP261X/GRP2624/GRP2634_gnu_gpl.zip

U.S. FCC Part 68 Regulatory Information

This equipment complies with Part 68 of the FCC rules. Located on the equipment is a label that contains, among other information, the ACTA registration number and ringer equivalence number (REN). If requested, this information must be provided to the telephone company.

The REN is used to determine the quantity of devices which may be connected to the telephone line. Excessive REN's on the telephone line may result in the devices not ringing in response to an incoming call. In most, but not all areas, the sum of the REN's should not exceed five (5.0). To be certain of the number of devices that may be connected to the line, as determined by the total REN's contact the telephone company to determine the maximum REN for the calling area.

This equipment cannot be used on the telephone company-provided coin service. Connection to Party Line Service is subject to State Tariffs.

If this equipment causes harm to the telephone network, the telephone company will notify you in advance that temporary

discontinuance of service may be required. If advance notice isn't practical, the telephone company will notify the customer as soon as possible. Also, you will be advised of your right to file a complaint with the FCC if you believe it is necessary. The telephone company may make changes in its facilities, equipment, operations, or procedures that could affect the operation of the equipment. If this happens, the telephone company will provide advance notice in order for you to make the necessary modifications in order to maintain uninterrupted service.

If trouble is experienced with this equipment, please contact (Agent in the US):

Company Name: Grandstream Networks, Inc.

Address: 126 Brookline Ave, 3rd Floor Boston, MA 02215, USA

Tel: 1-617-5669300

If the trouble is causing harm to the telephone network, the telephone company may request you to remove the equipment from the network until the problem is resolved.

This equipment uses the following USOC jacks: RJ45C.

It is recommended that the customer install an AC surge arrester in the AC outlet to which this device is connected. This is to avoid damaging the equipment caused by local lightning strikes and other electrical surges.

Since this device has the HAC function, the earpiece is easy to absorb small, please take care to avoid scratching.

U.S. FCC Part 15 Regulatory Information

This device complies with part 15 of the FCC Rules. Operation is subject to the following two conditions: (1) This device may not cause harmful interference, and (2) this device must accept any interference received, including interference that may cause undesired operation.

Any Changes or modifications not expressly approved by the party responsible for compliance could void the user's authority to operate the equipment.

Note: This equipment has been tested and found to comply with the limits for a Class B digital device, pursuant to part 15 of the FCC Rules. These limits are designed to provide reasonable protection against harmful interference in a residential installation. This equipment generates, uses and can radiate radio frequency energy and, if not installed and used in accordance with the instructions, may cause harmful interference to radio communications. However, there is no guarantee that interference will not occur in a particular installation. If this equipment does cause harmful interference to radio or television reception, which can be determined by turning the equipment off and on, the user is encouraged to try to correct the interference by one or more of the following measures:

- Reorient or relocate the receiving antenna.
- Increase the separation between the equipment and receiver.
- Connect the equipment into an outlet on a circuit different from that to which the receiver is connected.
- Consult the dealer or an experienced radio/TV technician for help.

This equipment complies with FCC radiation exposure limits set forth for an uncontrolled environment. This equipment should be installed and operated with minimum distance 20cm between the radiator & your body. This transmitter must not be co-located or operating in conjunction with any other antenna or transmitter.

Directive 2014/53/EU Regulatory Information

This applies to GRP2612W/GRP2614/GRP2615/GRP2616 only

Operating Frequency Band (RF)	Max Power	
	2402-2480MHz (TX&RX)	BT-EDR
2402-2480MHz (TX&RX)	BT-BLE	7.21dBm
2402-2480MHz (TX&RX)	802.11b	18.15dBm
	802.11g	18.42dBm

	802.11n-20	19.06dBm
2402-2480MHz (TX&RX)	802.11a	19.28dBm
	802.11n-20	18.78dBm
	802.11n-40	19.10dBm
	802.11ac20	18.89dBm
	802.11ac40	18.66dBm
	802.11ac80	15.80dBm
5250-5350MHz (TX&RX)	802.11a	18.63dBm
	802.11n-20	18.60dBm
	802.11n-40	18.93dBm
	802.11ac20	18.59dBm
	802.11ac40	18.38dBm
	802.11ac80	15.85dBm
5470-5725MHz (TX&RX)	802.11a	18.19dBm
	802.11n-20	18.32dBm
	802.11n-40	18.34dBm
	802.11ac20	18.44dBm
	802.11ac40	17.72dBm
	802.11ac80	15.45dBm

Caution: Exposure to Radio Frequency Radiation

This equipment complies with EU radiation exposure limits set forth for an uncontrolled environment. This equipment should be installed and operated with minimum distance of 20 cm between the radiator and your body.

For GRP2613:

U.S. FCC Part 15 Regulatory Information

This device complies with part 15 of the FCC Rules. Operation is subject to the following two conditions: (1) this device may not cause harmful interference, and (2) this device must accept any interference received, including interference that may cause undesired operation. Any Changes or modifications not expressly approved by the party responsible for compliance could void the user's authority to operate the equipment.

Note: This equipment has been tested and found to comply with the limits for a Class B digital device, pursuant to part 15 of the FCC Rules. These limits are designed to provide reasonable protection against harmful interference in a residential installation. This equipment generates, uses and can radiate radio frequency energy and, if not installed and used in accordance with the instructions, may cause harmful interference to radio communications. However, there is no guarantee that interference will not occur in a

particular installation. If this equipment does cause harmful interference to radio or television reception, which can be determined by turning the equipment off and on, the user is encouraged to try to correct the interference by one or more of the following measures:

- Reorient or relocate the receiving antenna.
- Increase the separation between the equipment and receiver.
- Connect the equipment into an outlet on a circuit different from that to which the receiver is connected.
- Consult the dealer or an experienced radio/TV technician for help.

U.S. FCC Part 68 Regulatory Information

This equipment complies with Part 68 of the FCC rules. Located on the equipment is a label that contains, among other information, the ACTA registration number and ringer equivalence number (REN.) If requested, this information must be provided to the telephone company.

The REN is used to determine the quantity of devices which may be connected to the telephone line. Excessive REN's on the telephone line may result in the devices not ringing in response to an incoming call. In most, but not all areas, the sum of the REN's should not exceed five (5.0). To be certain of the number of devices that may be connected to the line, as determined by the total REN's contact the telephone company to determine the maximum REN for the calling area.

This equipment cannot be used on the telephone company-provided coin service. Connection to Party Line Service is subject to State Tariffs.

If this equipment causes harm to the telephone network, the telephone company will notify you in advance that temporary discontinuance of service may be required. If advance notice isn't practical, the telephone company will notify the customer as soon as possible. Also, you will be advised of your right to file a complaint with the FCC if you believe it is necessary.

The telephone company may make changes in its facilities, equipment, operations, or procedures that could affect the operation of the equipment. If this happens, the telephone company will provide advance notice in order for you to make the necessary modifications in order to maintain uninterrupted service.

If the trouble is causing harm to the telephone network, the telephone company may request you to remove the equipment from the network until the problem is resolved.

This equipment uses the following USOC jacks: RJ45C.

It is recommended that the customer install an AC surge arrester in the AC outlet to which this device is connected. This is to avoid damaging the equipment caused by local lightning strikes and other electrical surges.

Terminal equipment

This product meets the applicable Innovation, Science and Economic Development Canada technical specifications.

The Ringer Equivalence Number (REN) indicates the maximum number of devices allowed to be connected to a telephone interface. The termination of an interface may consist of any combination of devices subject only to the requirement that the sum of the RENs of all the devices not exceed five.

Ce produit répond à la innovation, des sciences et de Développement économique Canada spécifications techniques applicables.

Le nombre équivalent de sonneries (REN) indique le nombre maximal de terminaux qui peuvent être raccordés à une interface téléphonique. La terminaison d'une interface peut consister en une combinaison de dispositifs, à la seule condition que la somme des REN de tous les dispositifs ne dépasse pas cinq.

CAN ICES-003 (B) / NMB-003(B)

If trouble is experienced with this equipment, please contact (Agent in the US):

Company Name: Grandstream Networks, Inc.

Address: 126 Brookline Ave., 3rd Floor Boston, MA 02215, USA

Tel: 1-617-5669300

CE Authentication



BE	BG	CZ	DK	DE	EE	IE	EL	LI	
ES	FR	HR	IT	CY	LV	LT	LU	CH	
HU	MT	NL	AT	PL	PT	RO	SI	TR	
SK	FI	SE	NO	IS	UK	UK(NI)			

In the UK and EU member states, operation of 5150-5350 MHz is restricted to indoor use only.

Hereby, Grandstream Networks, Inc. declares that the radio equipment GRP2612W, GRP2614, GRP2615 and GRP2616 are in compliance with Directive 2014/53/EU.

The full text of the EU declaration of conformity is available at the following internet address:

<https://www.grandstream.com/support/resources/>

Copyright

©2024 Grandstream Networks, Inc. <https://www.grandstream.com>

All rights reserved. Information in this document is subject to change without notice. Reproduction or transmittal of the entire or any part, in any form or by any means, electronic or print, for any purpose without the express written permission of Grandstream Networks, Inc. is not permitted.

Grandstream is a registered trademark and the Grandstream logo is the trademark of Grandstream Networks, Inc. in the United States, Europe, and other countries.
