

Grandstream Networks, Inc.

DP755 - Administration Guide



WELCOME

Thank you for purchasing Grandstream DP755 DECT Cordless VoIP Base Station and DP DECT Cordless HD Handsets.

The DP755 is a powerful DECT VoIP Phone Base station that pairs with up to 10 of Grandstream's DP series DECT handsets to offer mobility to business and residential users. It supports a range of up to 400 meters with DP725/DP730/DP735 and up to 350 meters with DP720/DP722 outdoors and 50 meters indoors to give users the freedom to move around their work or home space, delivering efficient flexibility. This DECT VoIP Phone Base Station supports up to 10 handsets and 20 SIP accounts while also offering 3-way voice conferencing, full HD audio, and integrated PoE. A shared SIP account on all handsets will add seamless unified features that give users the ability to answer all calls regardless of location in real-time. The DP755 supports a variety of auto-provisioning methods and TLS/SRTP/HTTPS encryption security. When paired with Grandstream's DP720/DP722/DP725/DP730/DP735, the DP755 offers a powerful cordless DECT solution for any business or residential user.

PRODUCT OVERVIEW

Feature Highlights

The following tables contain the major features of the DP755 / DP730 / DP722:

o DP755

	<ul style="list-style-type: none">• 10 Handsets.• 20 accounts.• 10 Lines per handset.• 8 Concurrent calls.• PoE power support.• Range: Up to 400m with DP730 and up to 350m with DP722/DP720 outdoor / 50m range indoor.
---	---

DP755 Features at a Glance

o DP720

 DP720	<ul style="list-style-type: none">• DECT Cordless HD.• 1.8 inch (128x160) TFT color LCD.• 250 hours standby / 20 hours talk time. (laboratory data)• 21 languages embedded.• Up to 20 accounts.• 2 concurrent calls.• 9 ringtones.
--	--

DP720 Features at a Glance

o DP722

	<ul style="list-style-type: none">• DECT cordless HD.• 1.8 inch (128x160) color TFT LCD.• 250 hours standby / 20 hours talk time. (laboratory data)• 21 languages embedded.• Up to 20 accounts.• 2 concurrent calls.• 9 ringtones.
---	--

DP722 Features at a Glance

o DP725

	<ul style="list-style-type: none">• DECT cordless HD.• 1.8 inch (128x160) color TFT LCD.• 500 hours standby / 50 hours talk time. (laboratory data)• 21 languages embedded.• Up to 20 accounts.• 2 concurrent calls.• 9 ringtones.
---	--

DP725 Features at a Glance

o **DP730**

	<ul style="list-style-type: none"> • DECT cordless HD. • 2.4 inch (240x320) color TFT LCD. • 500 hours standby / 40 hours talk time. (laboratory data) • 21 languages embedded. • Up to 20 accounts. • 2 concurrent calls. • 9 ringtones.
---	--

DP730 Features at a Glance

o **DP735**

	<ul style="list-style-type: none"> • DECT cordless HD. • 2.4 inch (240x320) color TFT LCD. • 650 hours standby / 65 hours talk time (Laboratory data) • 21 languages embedded. • Up to 20 accounts. • 3-way audio conferencing. • Ruggedized design with IP67 Rated-Water-proof and dust-proof. • Antimicrobial casing. • Drop safe from 2.5m.
---	---

DP735 Features at a Glance

DP755 Technical Specifications

The following table resumes all the technical specifications including the protocols/standards supported, voice codecs, telephony features, languages, and upgrade/provisioning settings for the Base station DP755.

Air Interface	<p>Telephony standards: DECT</p> <p>Frequency bands:</p> <ul style="list-style-type: none"> • 1880 – 1900 MHz (Europe), 1920 – 1930 MHz (US) • 1910 – 1920 MHz (Brazil), 1786 – 1792 MHz (Korea) • 1893 – 1906 MHz (Japan), 1880 – 1895 MHz (Taiwan) <p>Number of channels: 10 (Europe), 5 (US, Brazil or Japan), 3 (Korea), 8 (Taiwan)</p> <p>Range: up to 400 meters outdoor and 50 meters indoor</p>
Peripherals	<p>3 LED indicators: Power, Network, DECT.</p> <p>Pairing/Paging button.</p> <p>One 10/100 Mbps auto-sensing Ethernet port with integrated PoE</p>
Protocols/Standards	<p>SIP RFC3261, TCP/IP/UDP, RTP/RTCP, HTTP/HTTPS, ARP/RARP, ICMP, DNS (A record, SRV, NAPTR), DHCP, PPPoE, SSH, TFTP, NTP, STUN, SIMPLE, LLDP-MED, LDAP, TR-069, 802.1x, TLS, SRTP</p>
Voice Codecs	<p>G.711µ/a-law, G.723.1, G.729A/B, G.726-32, iLBC, G.722, OPUS, G.722.2/AMR-WB (special order), in-band and out-of-band DTMF (in audio, RFC2833, SIP INFO), VAD, CNG, PLC, AJB</p>
Telephony Features	<p>Hold, transfer, forward, 3-way conference, push to talk, intercom, downloadable phonebook (XML, LDAP, up to 3000 entries), call waiting, call log (up to 300 records), auto answer, flexible dial plan, server redundancy and fail-over</p>
QoS	<p>Layer 2 QoS (802.1Q, 802.1p) and Layer 3 QoS (ToS, DiffServ, MPLS)</p>
Security	<p>User and administrator level access control, MD5 and MD5-sess based authentication, 256-bit AES encrypted configuration file, TLS, SRTP, HTTPS, 802.1x media access control, DECT authentication & encryption</p>
Multi-language	<p>Chinese Simple, Chinese Tradition, Czech, Danish, Dutch, English, Estonian, Finnish, French, German, Hebrew, Hungarian, Japanese, Korean, Norwegian, Portuguese, Romanian, Spanish, Swedish, Turkish.</p>
Upgrade/ Provisioning	<p>Firmware upgrade via HTTP/HTTPS or FTP/FTPS, mass provisioning using TR-069 or AES encrypted XML configuration file</p>
Multiple SIP Accounts	<p>Up to twenty (20) distinct SIP accounts per system</p> <p>Each handset may map to any SIP account(s)</p> <p>Each SIP account may map to any handsets(s)</p>
Ring Group	<ul style="list-style-type: none"> • Parallel Mode: All phones ring concurrently; after one phone answers, the remaining available phones can make new calls

	<ul style="list-style-type: none"> ● Circular Mode: All phones ring sequentially, beginning with the phone that follows the one that rang last.
Power & Green Energy Efficiency	Universal Power Supply Input AC 100-240V 50/60Hz; Output 5VDC, 1A; Micro-USB connection; PoE: IEEE802.3af Class 1, 0.44W–3.84W
Package Content	Base unit, Universal Power Supply, Ethernet cable, Quick Installation Guide, GPL Statement
Dimensions (H x W x D)	to be defined.
Weight	Base unit: 140g; Universal power supply: 50g; Package: 370g
Temperature and Humidity	Operation: -10° to 50°C (14 to 122°F); Storage: -20° to 60°C (-4 to 140°F); Humidity: 10% to 90% non-condensing
Compliance	FCC: FCC Part 15B; FCC Part 15D; SAR (FCC 47 CFR Part2.1093; IEEE 1528; IEC 62209-2); FCC Part68 HAC; FCC ID CE: EN 55032; EN 55035; EN 61000-3-2; EN 61000-3-3; EN 60950-1;EN 301 489-1/-6; EN 301 406; EN 50332-2; SAR(EN50360;EN50566;EN 50663;EN62209-1; EN62209-2; EN 62479); RED NB Cert RCM: AS/NZS CISPR32; AS/NZS 60950.1;AS/CA S004;AS/ACIF S040. ANATEL, EAC, UL(adapter).

DP755 Technical Specifications

DP720 Technical Specifications

The following table resumes all the technical specifications including the protocols/standards supported, voice codecs, telephony features, languages, and upgrade/provisioning settings for the DP720 handset:

Air Interface	Telephony standards: DECT Frequency bands: 1880 – 1900 MHz (Europe), 1920 – 1930 MHz (US) 1910 – 1920 MHz (Brazil), 1786 – 1792 MHz (Korea) 1893 – 1906 MHz (Japan), 1880 – 1895 MHz (Taiwan) Number of channels: 10 (Europe), 5 (US, Brazil or Japan), 3 (Korea), 8 (Taiwan) Outdoor Range: up to 350 meters (with DP755 and DP752) or up to 300 meters (DP750) Indoor Range: up to 50 meters
Peripherals	1.8 inch (128×160) color TFT LCD 23 keys including 2 softkeys, 5 navigation / menu keys, 4 dedicated function keys for SEND, POWER/END, SPEAKERPHONE, MUTE 3-color MWI LED 3.5mm headset jack Removable belt clip Micro-USB port for alternative charging and non-battery operation
Protocols/Standards	Hearing Aid Compatibility (HAC) compliant
Voice Codecs	G.722 codec for HD audio and G.726 codec for narrow band audio (G.711μ/a-law, G.723.1, G.729A/B, iLBC and OPUS are supported via companion DECT base station), AEC, AGC, Ambient noise reduction on handset mic, advanced noise suppression for incoming audio
Telephony Features	Hold, transfer, forward, 3-way conference, push-to-talk, intercom, downloadable phonebook, call waiting, call log, auto answer, click-to-dial, flexible dial plan
HD Audio	Yes, in both Handset and Speakerphone modes
Security	DECT authentication & encryption
Multi-language	English, Czech, German, Spanish, French, Hebrew, Italian, Dutch, Polish, Portuguese, Russian, Turkish, Arabic, Chinese Simple, Chinese Tradition, Japanese, Korean, Slovakian, Serbian, Greek, Swedish
Upgrade/ Provisioning	Software Upgrade Over-The-Air (SUOTA), handset provisioning Over-The-Air
Multiple Line Access	Each handset may access up to twenty (20) lines
Power & Green Energy Efficiency	Universal Power Supply Input AC 100-240V 50/60Hz; Output 5VDC 1A; Micro-USB connection; Rechargeable 800mAh Ni-MH Low Self-Discharge (LSD) AAA batteries (250 hours of standby time and 20 hours of talk time) (laboratory data)
Package Content	Handset unit, universal power supply, charger cradle, belt clip, 2 batteries, Quick Installation Guide
Dimensions (H x W x D)	Handset: 155 x 50 x 26 mm, charger cradle: 35 x 63.5 x 54 mm
Weight	Handset: 138g, charger cradle: 71g, universal power supply: 50g; Package: 360g

Temperature and Humidity	Operation: -10° to 50°C (14 to 122°F); Charging: 0 to 45°C (32 to 113°F); Storage: -20° to 60°C (-4 to 140°F); Humidity: 10% to 90% non-condensing
Compliance	FCC, CE, RCM, IC

DP720 Technical Specifications

DP722 Technical Specifications

The following table resumes all the technical specifications including the protocols/standards supported, voice codecs, telephony features, languages, and upgrade/provisioning settings for the DP722 handset:

Air Interface	<p>Telephony standards: DECT</p> <p>Frequency bands:</p> <ul style="list-style-type: none"> ● 1880 – 1900 MHz (Europe), 1920 – 1930 MHz (US) ● 1910 – 1920 MHz (Brazil), 1786 – 1792 MHz (Korea) ● 1893 – 1906 MHz (Japan), 1880 – 1895 MHz (Taiwan) <p>Number of channels: 10 (Europe), 5 (US, Brazil or Japan), 3 (Korea), 8 (Taiwan)</p> <p>Outdoor Range: up to 350 meters (with DP755 and DP752) or up to 300 meters (DP750)</p> <p>Indoor Range: up to 50 meters</p>
Peripherals	<p>1.8 inch (128×160) color TFT LCD</p> <p>23 keys including 2 softkeys, 5 navigation / menu keys, 4 dedicated function keys for SEND, POWER/END, SPEAKERPHONE, MUTE</p> <p>3-color MWI LED</p> <p>3.5mm headset jack</p> <p>Removable belt clip</p> <p>Micro-USB port for alternative charging and non-battery operation</p>
Protocols/Standards	Hearing Aid Compatibility (HAC) compliant
Voice Codecs	G.722 codec for HD audio and G.726 codec for narrow band audio (G.711μ/a-law, G.723.1, G.729A/B, iLBC and OPUS are supported via companion DECT base station), AEC, AGC, Ambient noise reduction on handset mic, advanced noise suppression for incoming audio
Telephony Features	Hold, transfer, forward, 3-way conference, push-to-talk, intercom, downloadable phonebook, call waiting, call log, auto answer, click-to-dial, flexible dial plan
HD Audio	Yes, in both Handsets and Speakerphone modes
Security	DECT authentication & encryption
Multi-language	English, Czech, German, Spanish, French, Hebrew, Italian, Dutch, Polish, Portuguese, Russian, Turkish, Arabic, Chinese Simple, Chinese Tradition, Japanese, Korean, Slovakian, Serbian, Greek, Swedish.
Upgrade/ Provisioning	Software Upgrade Over-The-Air (SUOTA), handsets provisioning Over-The-Air
Multiple Line Access	Each handset may access up to twenty (20) lines
Power & Green Energy Efficiency	Universal Power Supply Input AC 100-240V 50/60Hz; Output 5VDC 1A; Micro-USB connection; Rechargeable 800mAh Ni-MH Low Self-Discharge (LSD) AAA batteries (250 hours of standby time and 20 hours of talk time) (laboratory data)
Package Content	Handset unit, universal power supply, charger cradle, belt clip, 2 batteries, Quick Start Guide
Dimensions (H x W x D)	Handset: 158 x 50 x 28.1mm; Charger cradle: 81.15 x 75.89 x 36.36mm
Weight	Handset: 110g; Charger cradle: 44g; Universal power supply: 50g; Package: 328g
Temperature and Humidity	Operation: -10° to 50°C (14 to 122°F); Charging: 0 to 45°C (32 to 113°F); Storage: -20° to 60°C (-4 to 140°F); Humidity: 10% to 90% non-condensing
Compliance	FCC, CE, RCM, IC

DP722 Technical Specifications

DP725 Technical Specifications

The following table resumes all the technical specifications including the protocols/standards supported, voice codecs, telephony features, languages, and upgrade/provisioning settings for the DP725 handset:

Air Interface	<p>Telephony standards: DECT</p> <p>Frequency bands:</p> <p>1880 – 1900 MHz (Europe), 1920 – 1930 MHz (US),</p>
---------------	---

	1910 – 1920 MHz (Brazil), 1786 – 1792 MHz (Korea), 1893 – 1906 MHz (Japan), 1880 – 1895 MHz (Taiwan) Number of Channels: 10 (Europe), 5 (US, Brazil or Japan), 3 (Korea), 8 (Taiwan) Outdoor Range: up to 400 meters (DP752/DP755) or up to 300 meters (DP750) Indoor Range: up to 50 meters
Peripherals	1.8 inch (128x160) color TFT LCD 27 keys including 2 soft keys, 5 navigation/ menu keys, 5 dedicated function keys for SPEAKERPHONE, MUTE, SEND, POWER/END, 3 side keys including 2 volume (up and down) and 1 Push-to-Talk key, 3-color MWI LED 3.5mm headset jack Removable belt clip Type C USB port for alternative charging and non-battery operation
Protocols/Standards	Hearing Aid Compatibility (HAC) compliant
Voice Codecs	G.722 codec for HD audio and G.726 codec for narrow band audio (G.711µ/a-law, G.723.1, G.729A/B, iLBC and OPUS are supported via companion DECT base station), AEC, AGC, Ambient noise reduction on handset mic, advanced noise suppression for incoming audio
Telephony Features	Hold, transfer, forward, 3-way conference, push-to-talk, intercom, downloadable phonebook, call waiting, call log, auto answer, click-to-dial, flexible dial plan
HD Audio	Yes, both on Handset and Speakerphone
Security	DECT authentication & encryption
Multi-language	English, Czech, German, Spanish, French, Hebrew, Italian, Dutch, Polish, Portuguese, Russian, Turkish, Arabic, Chinese Simple, Chinese Tradition, Japanese, Korean, Slovakian, Serbian, Greek, Swedish
Upgrade/ Provisioning	Software Upgrade Over-The-Air (SUOTA), handset provisioning Over-The-Air
Multiple Line Access	Each handset may access up to twenty (20) lines
Power & Green Energy Efficiency	Universal Power Supply Input AC 100-240V 50/60Hz; Output 5VDC 1A; USB-C Connector; Rechargeable 1500mAh Li-ion battery (500 hours of standby time and 50 hours of talk time) (laboratory data)
Package Content	Handset unit, universal power supply, charger cradle, belt clip, 1 battery, Quick Installation Guide
Dimensions (H x W x D)	Handset: 135 x 49 x 15.5mm; Charger cradle: 85 x 85 x 25mm
Weight	Handset: 107g; Charger cradle: 61g; Universal power supply: 55g; Package: 364g
Temperature and Humidity	Operation: -10° to 45°C (14 to 113°F); Charging: 0 to 45°C (32 to 113°F) Storage: -20° to 60°C (-4 to 140°F); Humidity: 10% to 90% non-condensing
Compliance	FCC, CE, RCM, IC

DP725 Technical Specifications

DP730 Technical Specifications

The following table resumes all the technical specifications including the protocols/standards supported, voice codecs, telephony features, languages, and upgrade/provisioning settings for the DP730 handset:

Air Interface	Telephony standards: DECT Frequency bands: <ul style="list-style-type: none"> ● 1880 – 1900 MHz (Europe), 1920 – 1930 MHz (US) ● 1910 – 1920 MHz (Brazil), 1786 – 1792 MHz (Korea) ● 1893 – 1906 MHz (Japan), 1880 – 1895 MHz (Taiwan) Number of channels: 10 (Europe), 5 (US, Brazil or Japan), 3 (Korea), 8 (Taiwan) Outdoor Range: up to 400 meters (DP752/DP755) or up to 300 meters (DP750) Indoor Range: up to 50 meters
Peripherals	2.4 inch (240x320) color TFT LCD 27 keys including 3 soft keys, 5 navigation/ menu keys, 4 dedicated function keys for SEND, POWER/END, SPEAKERPHONE, MUTE, 3 side keys including 2 volume (up and down) and 1 Push-to-Talk key 3-color MWI LED 3.5mm headset jack Proximity and accelerometer sensors Backlit keypad Removable belt clip Micro-USB port for alternative charging and non-battery operation
Protocols/Standards	Hearing Aid Compatibility (HAC) compliant

Voice Codecs	G.722 codec for HD audio and G.726 codec for narrow band audio (G.711μ/a-law, G.723.1, G.729A/B, iLBC and OPUS are supported via companion DECT base station), AEC, AGC, Ambient noise reduction on handset mic, advanced noise suppression for incoming audio
Telephony Features	Hold, transfer, forward, 3-way conference, push-to-talk, intercom, downloadable phonebook, call waiting, call log, auto answer, click-to-dial, flexible dial plan
HD Audio	Yes, in both Handsets and Speakerphone modes
Security	DECT authentication & encryption
Multi-language	English, Czech, German, Spanish, French, Hebrew, Italian, Dutch, Polish, Portuguese, Russian, Turkish, Arabic, Chinese Simple, Chinese Tradition, Japanese, Korean, Slovakian, Serbian, Greek, Swedish.
Upgrade/ Provisioning	Software Upgrade Over-The-Air (SUOTA), handsets provisioning Over-The-Air
Multiple Line Access	Each handset may access up to twenty (20) lines
Power & Green Energy Efficiency	Universal Power Supply Input AC 100-240V 50/60Hz; Output 5VDC 1A; Micro-USB connection; Rechargeable Li-ion battery, 500 hours of standby time and 40 hours of talk time. (laboratory data)
Package Content	Handset unit, universal power supply, charger cradle, belt clip, 1 battery, Quick Installation Guide
Dimensions (H x W x D)	Handset: 168.5 x 52.5 x 21.8mm; Charger cradle: 76 x 73 x 81mm
Weight	Handset: 180g; Charger cradle: 78g; Universal power supply: 50g; Package: 465g
Temperature and Humidity	Operation: -10° to 50°C (14 to 122°F); Charging: 0 to 45°C (32 to 113°F); Storage: -20° to 60°C (-4 to 140°F); Humidity: 10% to 90% non-condensing
Compliance	FCC, CE, RCM, IC

DP730 Technical Specifications

DP735 Technical Specifications

The following table resumes all the technical specifications including the protocols/standards supported, voice codecs, telephony features, languages, and upgrade/provisioning settings for the DP735 handset:

Air Interface	Telephony standards: DECT Frequency bands: 1880 – 1900 MHz (Europe), 1920 – 1930 MHz (US), 1910 – 1920 MHz (Brazil), 1786 – 1792 MHz (Korea), 1893 – 1906 MHz (Japan), 1880 – 1895 MHz (Taiwan) Number of Channels: 10 (Europe), 5 (US, Brazil or Japan), 3 (Korea), 8 (Taiwan) Outdoor Range: up to 400 meters (DP752/DP755) or up to 300 meters (DP750) Indoor Range: up to 50 meters
Peripherals	2.4 inch (240x320) color TFT LCD 27 keys including 3 soft keys, 5 navigation/ menu keys, 4 dedicated function keys for SPEAKERPHONE, MUTE, SEND, POWER/END, 3 side keys including 2 volume (up and down) and 1 Push-to-Talk key 3-color MWI LED 3.5mm headset jack Proximity and accelerometer sensors Removable belt clip Micro-B USB port for alternative charging and non-battery operation Vibration Ring Mode
Protocol/Standards	Hearing Aid Compatibility (HAC) compliant
Voice Codecs	G.722 codec for HD audio and G.726 codec for narrow band audio (G.711μ/a-law, G.723.1, G.729A/B, iLBC and OPUS are supported via companion DECT base station), AEC, AGC, Ambient noise reduction on handset mic, advanced noise suppression for incoming audio
Telephony Features	Hold, transfer, forward, 3-way conference, push-to-talk, intercom, downloadable phonebook, call waiting, call log, auto answer, click-to-dial, flexible dial plan
HD Audio	Yes, both on Handset and Speakerphone
Security	DECT authentication & encryption
Multi-language	English, Czech, German, Spanish, French, Hebrew, Italian, Dutch, Polish, Portuguese, Russian, Turkish, Arabic, Chinese Simple, Chinese Tradition, Japanese, Korean, Slovakian, Serbian, Greek, Swedish
Upgrade/ Provisioning	Software Upgrade Over-The-Air (SUOTA), handset provisioning Over-The-Air

Multi-line Access	Each handset may access up to twenty (20) lines
Power & Green Energy Efficiency	Universal Power Supply Input AC 100-240V 50/60Hz; Output 5VDC 1A; Micro-B USB Connector; Rechargeable 2000mAh Li-ion battery, 650 hours of standby time and 65 hours of talk time (laboratory data)
Package Content	Handset unit, universal power supply, charger cradle, belt clip, 1 battery, Quick Start Guide
Dimensions (H x W x D)	Handset: 166.00 x 57.80 x 26.30mm; Charger cradle: 82.00 x 80.00 x 30.60mm
Weight	Handset: 221.5g; Charger cradle: 56g; Universal power supply: 55g; Package: 535g
Weatherproof	IP67 Rated-Water-proof, dust-proof, cleaning chemical resistant, anti-microbial casing and 2.5m drop safe
Temperature and Humidity	Operation: -10° to 45°C (14 to 113°F); Charging: 0 to 45°C (32 to 113°F) Storage: -20° to 60°C (-4 to 140°F); Humidity: 10% to 90% non-condensing
Compliance	FCC, CE, RCM, IC

DP735 Technical Specifications

GETTING STARTED

This chapter provides basic installation instructions including the list of the packaging contents and also information for obtaining the best performance with the DP720/DP722/DP725/DP730/DP735 DECT Cordless HD Handsets and the DP755 DECT Cordless VoIP Base Station.

Equipment Packaging

o DP755

DP755	<ul style="list-style-type: none"> ● 1 Base unit ● 1 Universal power supply 5V ● 1 Bracket ● 1 Ethernet cable ● 1 Quick Installation Guide
--------------	---

Equipment Packaging – DP755

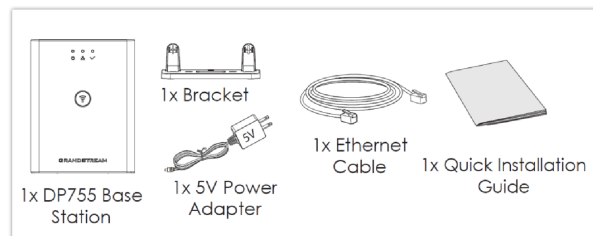

DP755 Package Content

o DP720

DP722	<ul style="list-style-type: none"> ● 1 Handset unit ● 1 Universal power supply 5V ● 1 Charging station ● 1 Handset Belt ● 2 Rechargeable batteries ● 1 Quick Installation Guide
--------------	---

Equipment Packaging – DP720



DP720 Package Content

o DP722

DP722	<ul style="list-style-type: none"> • 1 Handset unit • 1 Universal power supply 5V • 1 Charging station • 1 Handset Belt • 2 Rechargeable batteries • 1 Quick Installation Guide
-------	---

Equipment Packaging – DP722

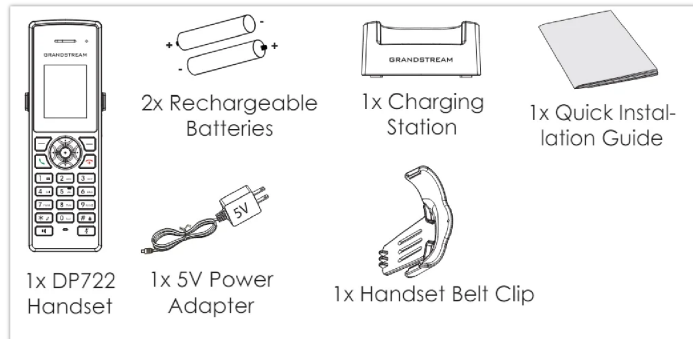

DP722 Package Content

o DP725

DP725	<ul style="list-style-type: none"> • 1 Handset unit • 1 Universal power supply 5V • 1 Charging Station • 1 Handset Belt Clip • 1 Rechargeable li-ion Battery • 1 Quick Installation Guide
-------	---

Equipment Packaging – DP725

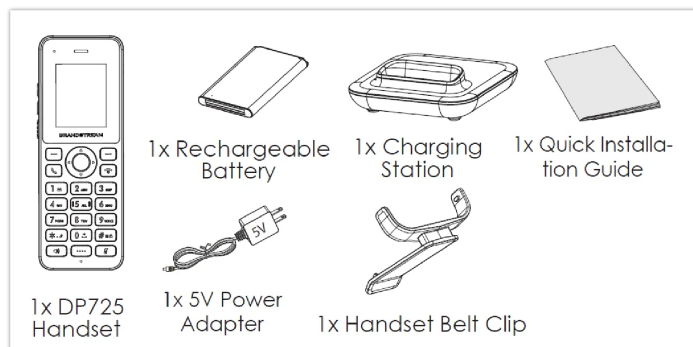

DP725 Package Content

o DP730

DP730	<ul style="list-style-type: none"> • 1 Handset unit • 1 Universal power supply 5V • 1 Charging station • 1 Handset Belt • 1 Rechargeable Li-ion battery • 1 Quick Installation Guide
-------	--

Equipment Packaging – DP730

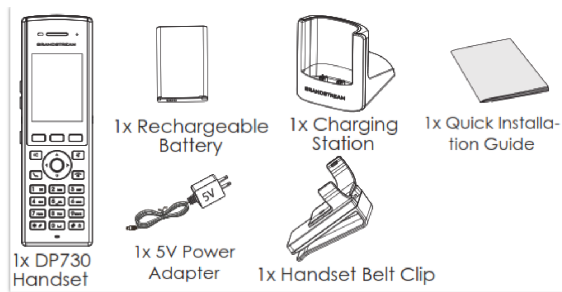

DP730 Package Content

o DP735

DP735	<ul style="list-style-type: none"> • 1 Handset unit • 1 Universal power supply 5V • 1 Charging Station • 1 Handset Belt Clip • 1x Rechargeable Battery • 1 Quick Installation Guide
-------	---

Equipment Packaging – DP735

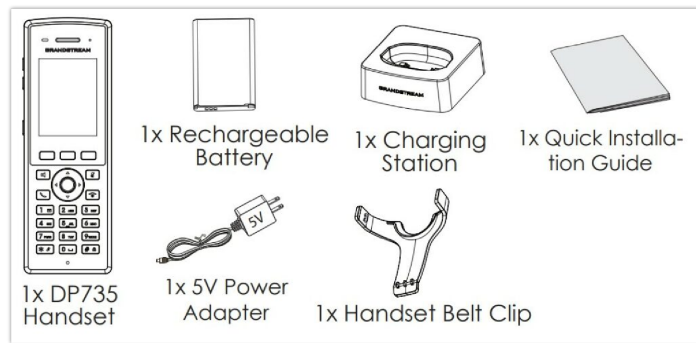

DP735 Package Content

Note

Check the package before installation. If you find anything missing, contact your system administrator.

Connecting DP755

To set up the DP755 DECT Cordless VoIP Base Station, please follow the steps below:

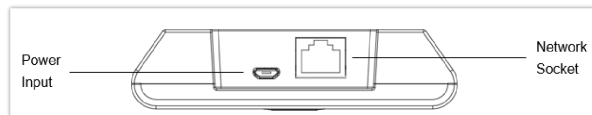

DP755 Back View

You have two options for power and network connection of the base station: AC power or Power over Ethernet (PoE).

Note

For better signal range, we recommend installing DP755 with LED side facing toward the usage area. Ceiling mount is recommended for better coverage.

Connecting via AC power

1. Connect the micro-USB connector to the related port on the base station and connect the other end of the power adapter to an electrical power outlet.
2. Connect the supplied Ethernet cable between the Internet port on the base station and the Internet port in your network or the switch/hub device port.

Connecting via PoE

To connect the base station using PoE, you need to connect the Ethernet cable provided (or 3rd party network cable) between the Network Socket on the base station to the Ethernet port of your PoE switch/hub.

Setting up DP720/DP722/DP725/DP730/DP735 Handsets

Please follow the below steps to insert batteries into the Handsets:

- o Open the battery compartment cover.
 1. For DP730/DP725/DP735: Inset the Li-ion battery with the electrodes in the bottom left corner.

2. For **DP722/DP720**: Insert AAA batteries with the correct polarity (+ / -).

- Close the battery compartment cover.

Note

Please charge the batteries fully before using the Handsets for the first time.

- **DP720**

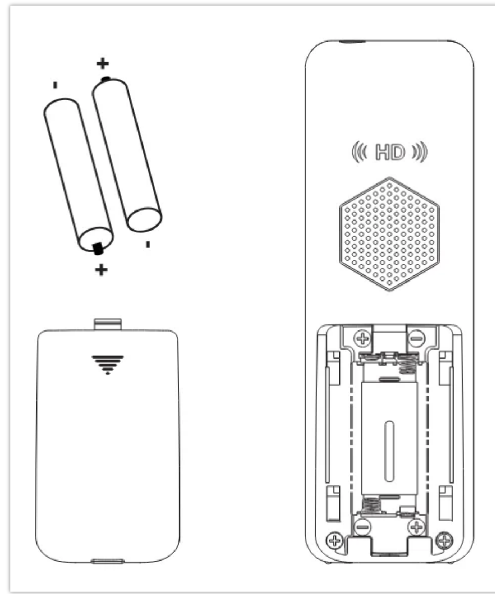

DP720 Battery Installation

- **DP722**

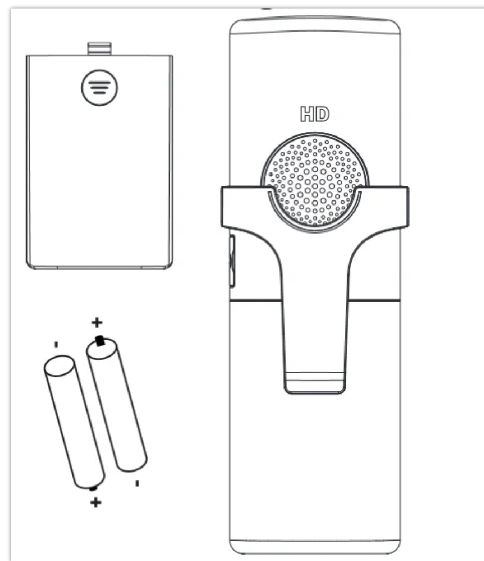

DP722 Battery Installation

- **DP725**

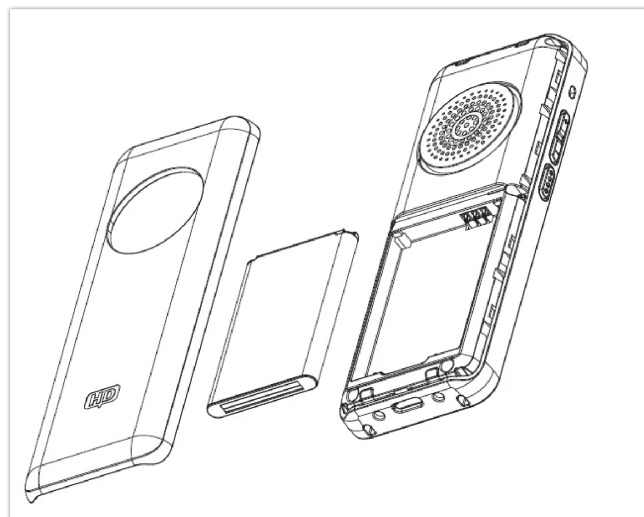

DP725 Battery Installation

○ DP730

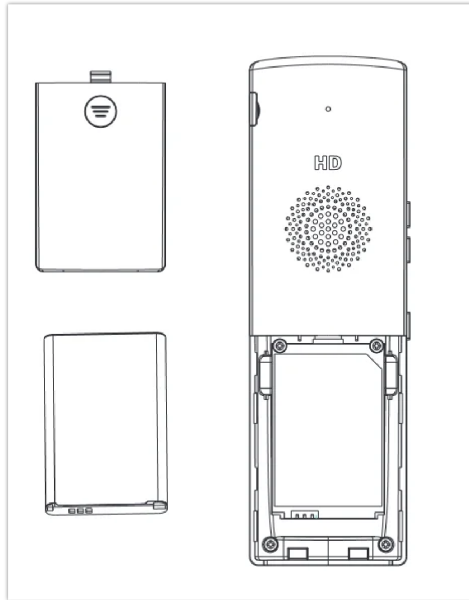

DP730 Battery Installation

○ DP735

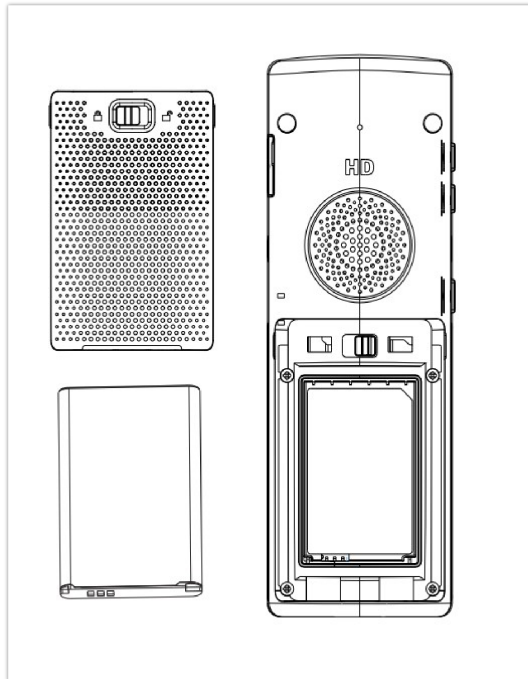

DP735 Battery Installation

Battery Information

DP720 battery specifications	DP722 Batteries Specifications	DP730 battery specifications	DP735 Batteries Specifications	DP725 battery specifications
<ul style="list-style-type: none"> ● Technology: Nickel Metal Hydride (Ni-MH) ● Size: AAA ● Voltage: 1.2V ● Capacity: 800mAh ● Standby time: up to 250 hours (laboratory data) ● Talk time: up to 20 hours of active talk time (laboratory data) 	<ul style="list-style-type: none"> ● Technology: Nickel Metal Hydride (Ni-MH) ● Size: AAA ● Voltage: 1.2V ● Capacity: 800mAh ● Standby time: up to 250 hours (laboratory data) ● Talk time: up to 20 hours of active talk time (laboratory data) 	<ul style="list-style-type: none"> ● Technology: Li-ion ● Nominal Voltage: 3.8V ● Capacity: 1500mAh ● Standby time: up to 500 hours (laboratory data) ● Talk time: up to 40 hours of active talk time (laboratory data) 	<ul style="list-style-type: none"> ● Technology: Li-ion ● Voltage: 3.8V ● Capacity: 2000mAh ● Standby time: up to 650 hours (laboratory data) ● Talk time: up to 65 hours of active talk time (laboratory data) 	<ul style="list-style-type: none"> ● Technology: Li-ion ● Nominal Voltage: 3.8V ● Capacity: 1500mAh ● Standby time: up to 500 hours (laboratory data) ● Talk time: up to 50 hours of active talk time (laboratory data)

DP Handsets Battery Specifications

In order to get the best performance of your DP Handsets, we recommend using the original batteries provided in the package or batteries compliant with the above specifications.

Disclaimer

The above mentioned battery specifications can vary and depend on many factors (age of the battery, number of recharge cycles, real capacity...). The recharge cycles of the battery are limited; thus, it might need to be replaced if the battery performance is low. The number of charge cycles and battery life are affected by usage and configuration.

Important Note

Be careful when inserting the batteries into your handset to avoid any risk of short-circuit, which lead to damage your batteries and/or the handset itself. Do not use damaged batteries which can increase the risk of serious harm.

Setting up the Charge Station

Please refer to the following steps for setting up the charge station and charging the Handsets:

1. Connect the DC plug on the power adapter to the micro-USB or Type-C connector on the charge station.
2. Connect the other end of the power adapter to an electrical power outlet.
3. After setting up the Handsets and the charge station, place the Handsets in the charge station.

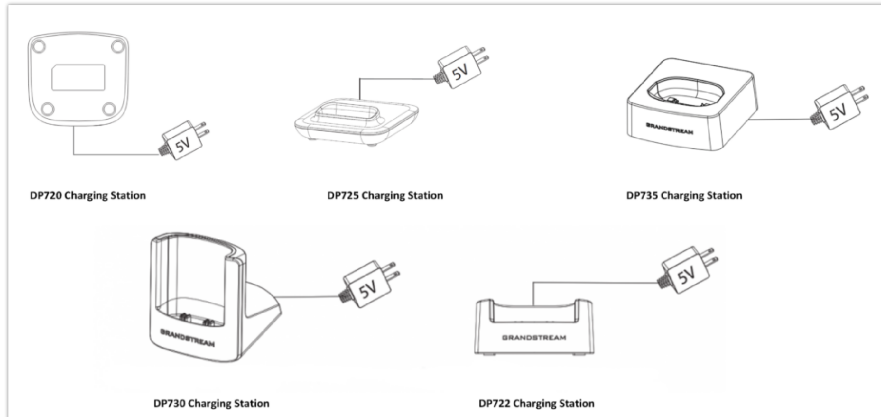







DP Handsets Charging Stations

DP755 LED Patterns

The DP755 has 3 LED lights on it. Please refer to the following table for the meaning of each light.



DP755 LED Patterns

LED Light	Status
	Indicates Power ON/OFF.
	Indicates the status of SIP account registration and network. <ul style="list-style-type: none">• Solid ON: SIP account registered.• Blinking: SIP account not registered or network error.
	Indicates the status of the DECT handset registration: <ul style="list-style-type: none">• Solid ON: Handset registered to the base.• Fast Blinking (0.25s ON/0.25s OFF): Paging handset.• Blinking (0.5s ON/0.5s OFF): Pairing mode.
  	Indicates the status if 3 LEDs are blinking: <ul style="list-style-type: none">• Blinking (0.5s ON/0.5s OFF): Firmware upgrade.• Fast Blinking (0.25s ON/0.25s OFF): Factory reset.

DP Handsets Description

The LCD screen and the Keypad are the main hardware components of the DP handsets.

- **DP720**

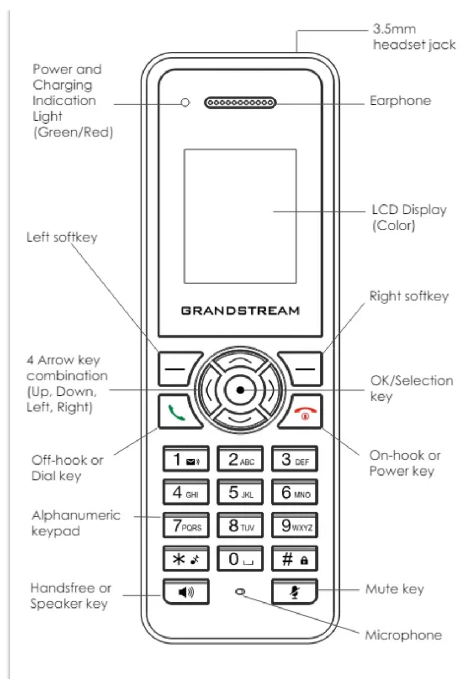

DP720 Handset Keys

	Key	Description
1	Power and Charging Indication Light	Red: Charging. Green: Charge completed. Blinking: Missed call(s) or Voice Mail received.
2, 10	Left and right softkeys	Correspond to functions displayed on the LCD. These functions change depending on the current context.
3	4 Arrow key combination	Correspond to functions displayed on the LCD. These functions change depending on the current context.
4	Off-hook / Dial key	Shows call information, handset status icons, prompt messages, etc.
5	Alphanumeric Keypad	Permits navigation of the cursor through the displayed menu options.
6	Hands-free / Speaker key	Selects the option chosen by the cursor. (Enters the main menu from the home screen.)
7	3.5mm Headset jack	Enters dialing mode, or dials number entered.
8	Earphone	Delivers audio output.
11	OK/Selection key	Selects the option chosen by the cursor. (Enters the main menu from the home screen.)
12	On-hook / Power key	Terminates calls, or turns the handset on / off.
13	Mute key	Activates or deactivates the mute feature.
14	Microphone	Picks up audio earpiece and hands-free calls.

DP720 Handset Keys Description

- o DP722

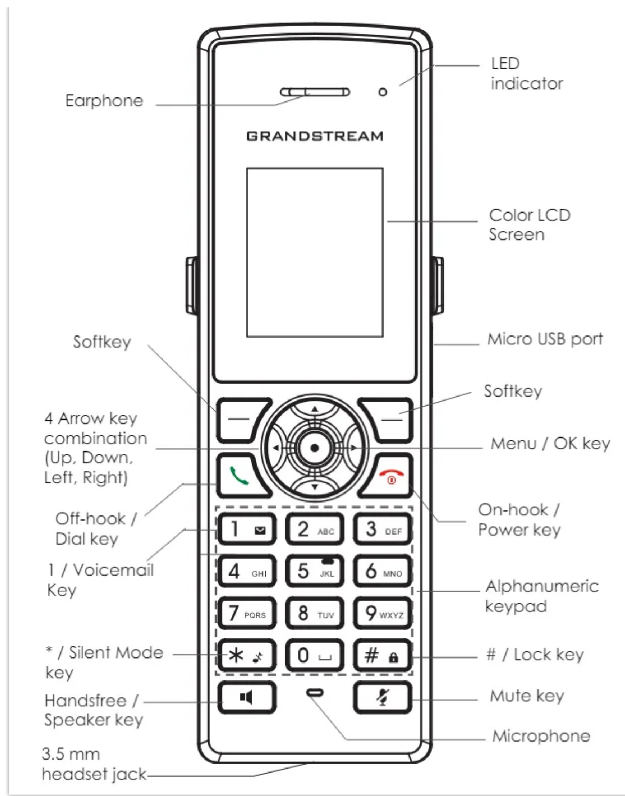

DP722 Keys Description

[wptb id="76974" not found]

DP722 Handset Keys Description

o DP725

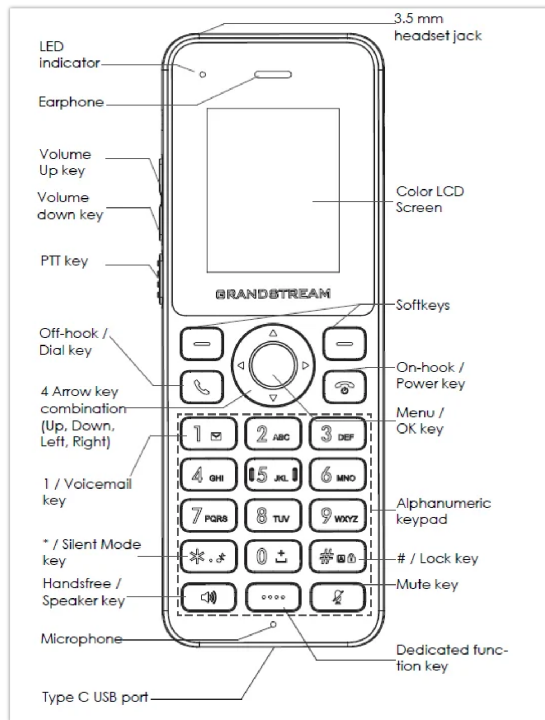

DP725 Handset Keys

	Key	Description
1	LED Indicator	Red: Charging Green: Charge completed Blinking green: Missed call(s) or Voice Mail received Blinking red: Low Battery
2	Earphone	Delivers audio output.
3	Volume Up key	Increases the audio volume during calls or while using other audio features.
4	Volume down key	Decreases the audio volume during calls or while using other audio features.

5	PTT key	Used for instant communication similar to a walkie-talkie, allowing the user to press and hold to talk and release to listen.
6	Off-hook /Dial key	Initiates a call or dials the number entered. It can also bring the handset into dialing mode from the home screen.
7	4 Arrow key combination (Up, Down, Left, Right)	Allows the user to navigate through the menu options and settings on the LCD screen.
8	1 / Voicemail key	Directly accesses the voicemail system, allowing the user to listen to and manage their voice messages.
9	Handsfree / Speaker key	Switches the call to the hands-free speaker mode, enabling the user to speak and listen without holding the handset.
10	Microphone	Captures the user's voice during calls, ensuring clear communication.
11	Type C USB port	Used for charging the handset.
12	Dedicated function key	Executes a specific function that varies depending on the current context or application being used.
13	Mute key	Toggles the mute feature on or off, allowing the user to mute their microphone during a call.
14	# / Lock key	Locks the keypad to prevent accidental key presses. To lock the keypad, press and hold the # key for about 2 seconds. To unlock, press the Unlock softkey and then the # key.
15	Alphanumeric keypad	Provides numbers, letters, and special characters for dialing phone numbers, entering text, or navigating through the menu.
16	Menu /OK key	Opens the main menu from the home screen and confirms selections or actions within the menu.
17	On-hook /Power key	Ends calls or turns the handset on and off. When the handset is off, holding this key will power it on; pressing it during a call will end the call.
18	Softkeys	Perform functions displayed on the LCD screen directly above them. The functions change depending on the current menu or application.
19	Color LCD Screen	Displays all relevant information such as call details, status icons, prompt messages, and menu options. It is the main interface for interacting with the handset.
20	3.5 mm headset jack	Allows the user to connect a wired headset for audio input and output, providing an alternative to the built-in microphone and speaker.

DP725 Handset Key Descriptions

- **DP730**

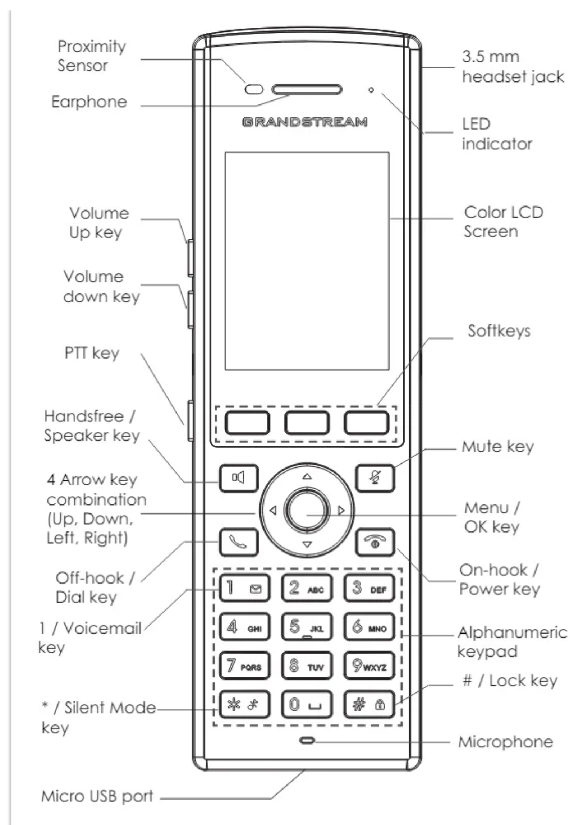

DP730 Handset Keys

[wptb id="76974" not found]

DP730 Keys Description

o DP735

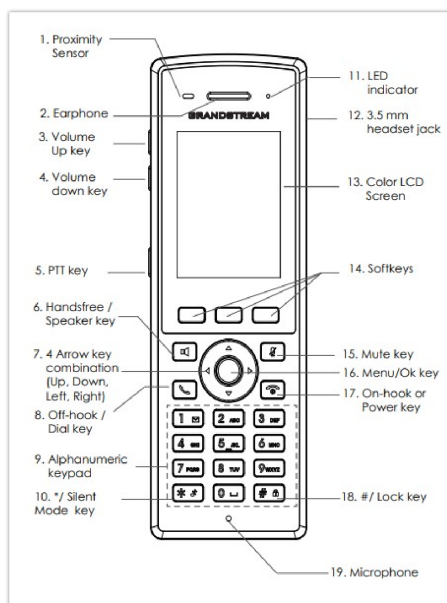

DP735 Handset Keys

	Key	Description
1	Proximity Sensor	The proximity sensor can detect and measure gravitational acceleration, tilt, vibration, altitude changes, and static position.
2	Earphone	Delivers audio output.
3	Volume Up key	Increases the audio volume during calls or while using other audio features.
4	Volume down key	Decreases the audio volume during calls or while using other audio features.
5	PTT key	Used for instant communication similar to a walkie-talkie, allowing the user to press and hold to talk and release to listen.

























6	Handsfree /Speaker key	Switches between handset and hands-free / speaker modes.
7	4 Arrow key combination (Up, Down, Left, Right)	Allows the user to navigate through the menu options and settings on the LCD screen.
8	Off-hook /Dial key	Initiates a call or dials the number entered. It can also bring the handset into dialing mode from the home screen.
9	Alphanumeric keypad	Provides numbers, letters, and special characters for dialing phone numbers, entering text, or navigating through the menu.
10	* / Silent Mode key	Activates or deactivates the silent mode (no ringtone heard during an incoming call) when keep pressing on * in idle screen.
11	LED indicator	Red: Charging Green: Charge completed Blinking green: Missed call(s) or Voice Mail received Blinking red: Low Battery
12	3.5 mm headset jack	Allows the user to connect a wired headset for audio input and output, providing an alternative to the built-in microphone and speaker.
13	Color LCD Screen	2.4-inch (240×320) TFT color LCD
14	Softkeys	Perform functions displayed on the LCD screen directly above them. The functions change depending on the current menu or application.
15	Mute key	Activates or deactivates the mute feature.
16	Menu/Ok key	Selects the option chosen by the cursor or enter the main menu from the home screen.
17	On-hook or Power key	Terminates calls or turns the handset on / off.
18	# / Lock key	Locks keypad against unintentional entries when keep pressing #. Press and hold the # key for approximately 2 seconds to lock the keys. Press Unlock Softkey and then # to unlock the keys.
19	Microphone	Picks up audio earpiece and hands-free calls.

DP735 Handset Key Descriptions

DP Handsets Icons Description

The following table contains description of each icon that might be displayed on the LCD screen of the DP720/DP722/DP725/DP730/DP735 handset.

	Battery status Not equipped with a battery
	Battery status Battery empty
	Battery status Battery low
	Battery status Battery normal
	Battery status Battery full
	Battery status Charging
	Signal status Not subscribed

	Signal status Not in range
	Signal status Signal very low
	Signal status Signal low
	Signal status Signal normal
	Signal status Signal good
	Signal status Signal very good
	Microphone MUTE Status OFF – Not muted ON – Muted
	Speaker status OFF – The speaker is inactivated ON – The speaker is activated
	Headset icon
	Missed Call icon
	Voicemail icon
	Ringtone status OFF – Ringtone off (Silent mode) ON – Ringtone on
	Keypad Lock status OFF – Keypad unlock ON – Keypad locked
	DND Status. OFF – Do Not Disturb disabled ON – Do Not Disturb enabled
	Call waiting
	Information
	Account not registered
	Account Registered
	Error message
	Handset number
	Incoming Call notification
	Outgoing Call notification
	Missed Call notification
	Voicemail notification
	Contacts

	Call History
	Registration
	Voice Mail
	Preferences
	Shortcut
	Call Features
	Status
	Settings

Handsets Icon Descriptions

DP Handsets Menu

The Handsets has an easy-to-use menu structure. Every menu opens a list of options. To open the main menu, press "Menu" (left softkey) when the Handsets is on and in standby mode. Press the Arrow keys to navigate to the menu option you require. Then press "Select" (left softkey) or OK/Selection key to access further options or confirm the setting displayed. To go to the previous menu item, press "Back" (right softkey). You can press the Power key at any time to cancel and return to standby mode. If you do not press any key, the Handsets automatically revert to standby mode after 20 seconds.

Note

Users can navigate through the handset menu by pressing the menu number when displayed.

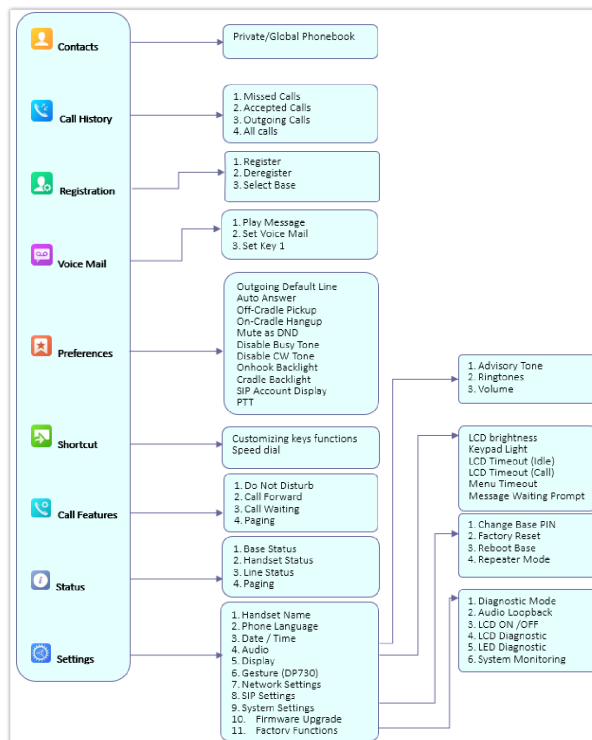

DP Handsets Menu Structure

Contacts	<ul style="list-style-type: none"> • Private: Private contacts include contacts visible in the current Handsets only. • Global: Global phonebook contacts are the contacts shared between the Handsets subscribed to the base station. <p>Notes:</p> <ul style="list-style-type: none"> • Private/Global Phonebooks will be merged on the handset. • When searching contacts for handsets subscribed to a DP750/DP752 base station, only the contacts starting with the searched letter will be displayed.
Call History	<p>Display the call history:</p> <ol style="list-style-type: none"> 1. Missed Calls. 2. Accepted Calls.

	<p>3. Outgoing Calls.</p> <p>4. All Calls.</p> <p>Notes:</p> <ul style="list-style-type: none"> You can add contacts to Shared Contacts directly from call logs. When deploying a BroadSoft XSI directory, users can access and view call logs recorded by the BroadSoft SIP server. The call logs are equipped with sorting functionality, allowing them to be organized by name or date, and can also be deleted as needed. In parallel ringing mode, the missed call indicator is automatically cleared on all handsets once any device in the group checks the call history.
Registration	<ul style="list-style-type: none"> Register: Register your handset to base station. Deregister: Deregister your handset from base station. Select Base: Select base station.
Voice Mail	<ul style="list-style-type: none"> Play Message: Play voice mail messages received. Set Voice Mail: Configure voice mail parameters. Set Key 1: Configure Key 1 as VM speed dial for selected account.
Preferences	<ul style="list-style-type: none"> Outgoing Default Line: Select account to be use by default for outgoing calls. Auto Answer: Enable/Disable Auto Answer. (Default is Disabled). Off-Cradle Pickup: Enable/Disable Off-Cradle Pickup. If enabled, users can answer the calls by picking up the handset off-cradle. (Default is Disabled). On-Cradle Hangup: Enable/Disable On-Cradle Hangup. If enabled, users can end the call by placing the handset on-cradle. (Default is Disabled). Mute as DND: Enable/Disable Mute as DND. If enabled, pressing mute key on idle state will set the phone to DND mode. (Default is Enabled) Disable Busy Tone: Enable/Disable Busy Tone. If set to enabled, busy tone will not be played. (Default is Disabled). Disable CW Tone: Enable/Disable CW Tone. If set to enabled, Call Waiting Tone will not be played. (Default is Disabled). Onhook Backlight: Enable/Disable Onhook Backlight. If enabled, pressing "Hangup" key on idle screen will switch off LCD screen. (Default is Disabled) Cradle Backlight: Enable/Disable/Dim Cradle Backlight. If enabled, LCD will remain backlit when the handset is placed on-cradle/charging. If set to "Dim", LCD brightness will be reduced when the handset is placed on-cradle/charging. (Default is Disabled) SIP Account Display: Select which SIP Account information will be displayed on the screen. Name Only: Display SIP Account Name only. (Default) ID Only: Display SIP User ID only. None: No account information will be displayed. PTT (Push To Talk): Enable/Disable Push To Talk. If set to enabled, pressing and hold PTT hard/soft key, a PTT call will be initiated. Pressing the PTT hard/soft key, it will redirect you to the setting to enable or disable it. (Default is Disabled)
Customizing keys functions	<p>Customizing keys functions:</p> <ul style="list-style-type: none"> L : Configure Left Softkey function in idle. Function can be set as Menu, History, Contacts, Line or PTT. Default is Menu. R : Configure Right Softkey function. Function can be set as History, Contacts, Line or PTT Default is Contacts. ▲ : Configure Arrow UP Key function. Default is Outgoing Calls (Call History). ▼ : Configure Arrow DOWN key function. Default is Accepted Calls (Call History). ◀ : Configure Arrow LEFT key function. Default is Ringer Volume Down. ▶ : Configure Arrow RIGHT key function. Default is Ringer Volume Up. <p>Select key and press OK button to configure function. Following functions are available for arrow keys: 1. Disabled, 2. Missed Calls, 3: Accepted Calls, 4: Outgoing Calls, 5: History, 6: Contacts, 7: Status, 8: Line, 9: Voice Mail, 10: Ringer Volume Up, 11: Ringer Volume Down, 12: Audio Volume Up, 13: Audio Volume Down, 14: Intercom.</p> <ul style="list-style-type: none"> Speed Dial: Assign contact numbers as speed dial. <p>Select a key [2], [3], [4], [5], [6], [7], [8] or [9] and press OK button. Select "Edit" to manually specify the destination number or select "From Contacts" to select a contact as speed dial destination.</p>
Call Features	<ul style="list-style-type: none"> Do Not Disturb: Enable/disable do not disturb mode on the phone. Call Forward: Configure call forward feature. Call Waiting: Configure call waiting feature. Paging: Configures Inter-Handsets paging feature.
Status	<ul style="list-style-type: none"> Base Status: Display Base status (Firmware, IP address, Subnet mask, Gateway, MAC Address, Serial Number) Handset Statut: Display Handsets status (Model RF, Firmware, IPEI) Line Status: Display Line status (Account name, Status)
Settings	<ul style="list-style-type: none"> Handset Name: Change the Handset name. Phone Language: Select the language to be displayed on the phone's LCD. (Default is English.) Date/Time: Configure date and time on the Handsets. Audio & Vibration: Specify ringtones for internal/external calls, the volume, advisory tones (Keypad, Confirmation, Low battery notifications), Handset TX Gain (-6dB, 0dB, +6dB), and Vibration mode (DP735/DP730 only). Display: Configure backlight, LCD timeout (Idle/Call), LCD brightness, Message Waiting Prompt and menu key timeout. Gestures (DP735/DP730 only): Configure Close-to-Ear Backlight and Facedown Hangup. Network Settings: Configure IP addresses and select DHCP/Static IP mode. SIP Settings: Configure/View SIP accounts settings.

- **System Settings:** Change Base PIN code, perform factory reset, reboot base and configure repeater mode.
- **Firmware Upgrade:** Upgrade the firmware version of the Handsets.
- **Factory Functions:** Diagnostic Mode (DP722) / Keypad Diagnostic (DP735/DP730)

All LEDs will light up, and the LCD will display a table listing the names of all keys in red. Press any key to diagnose; the key's name will display in blue. After all keys are diagnosed, a prompt message ("PASS") will display; press "Back" (right softkey) to exit.

Note: User can long press arrow UP key to exit at any time.

- **Audio Loopback:** Speak to the phone using speaker/Handsets/headset. If you can hear your voice, your audio is working fine. Press "Exit" softkey to exit audio loopback mode.
- **LCD ON / OFF:** Select this option to turn off LCD. Press any button to turn on LCD.
- **LCD Diagnostic:** Select this option to enter LCD Diagnostic mode. Press "Next" (left softkey) to display white screen. Continue pressing the left softkey to view all remaining screens (black, blue, red, and green) and then exit. End the test early by pressing the right softkey.
- **LED Diagnostic:** Enters this option and press "1" to start LED Diagnostic (you will notice that the color of the LED will be changing). Press "2" to quit.
- **System Monitoring:** Displays RSSI with its corresponding frequency, battery voltage and RPN information.
- **Vibration (DP735/DP730):** Test vibration on DP735/DP730.
- **Acceleration Sensor (DP735/DP730):** Displays X, Y, Z coordinates.
- **Proximity Sensor (DP735/DP730):** Test proximity sensor on DP735/DP730.

DP Handsets Menu Structure Definitions

CONFIGURATION GUIDE





The DP755 can be configured using:

- Web GUI embedded on the DP755 using PC's web browser.
- LCD Configuration Menu using the paired DP720/DP722/DP725/DP730/DP735 keypad.

Via Web GUI you can configure all the functions supported by the DP755; while via paired DP720/DP722/DP725/DP730/DP735, you can access limited configuration and need the base station PIN code for some options.

Obtain DP755 Base Station IP Address via Paired DP Handset

DP755 is by default configured to obtain IP address from DHCP server where the unit is located. In order to know which IP address is assigned to your DP755, please follow below steps using a paired DP720/DP722/DP725/DP730/DP735 handset with your DP755 base station.

1. Press "Menu" (left softkey)  or **OK** button  on DP720/DP722/DP725/DP730/DP735 to view operation menu.
2. Press Arrow (Up, Down, Left, Right) keys to move the cursor to **Status** icon , then press "Select" (left softkey)  or **OK** button , then select **Base Status**.
3. Using Arrow keys, navigate down to view the IP address of the DP755.

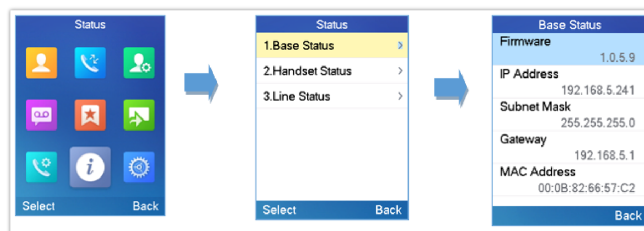

Base Status

Configuration via Web Browser

The DP755 embedded Web server responds to HTTP/HTTPS GET/POST requests. Embedded HTML pages allow a user to configure the DP755 through a Web browser such as Google Chrome, Mozilla Firefox, and Microsoft's IE.

Accessing the Web UI

1. Connect the computer to the same network as DP755.
2. Make sure the DP755 is booted up.
3. You may check the DP755 IP address via a subscribed DP720/DP722/DP725/DP730/DP735 on its LCD menu at **Status** → **Base Status** → **IP Address**. Please see [Obtain DP755 Base station IP Address via paired DP Handset](#).
4. Open the Web browser on your computer.
5. Enter the DP755's IP address in the address bar of the browser.
6. Enter the administrator's username and password to access the Web Configuration Menu.

Note

The computer must be connected to the same sub-network as the DP755. This can be easily done by connecting the computer to the same hub or switch as the DP755.

Remote Access to Web UI through GDMS

The DP755 supports remote management capabilities by enabling remote access to the base station's Web UI via Grandstream Device Management System (GDMS).

Before proceeding, ensure that the DP755 base station is added under "VoIP Device" in your GDMS account and is running firmware version **1.0.3.19 or higher**.

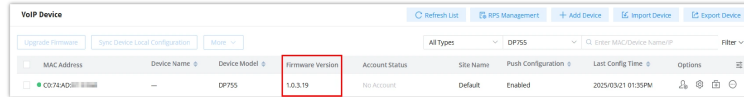

GDMS VoIP Device Page

To remotely access the phone's web UI, hover over "Additional Options" and select "Remote Access to Web UI".

A window will appear, informing you of temporary access (1 hour), and you will be redirected to the web UI.

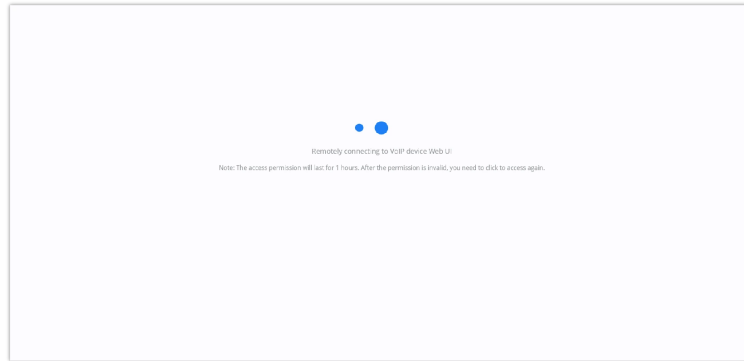

Remotely Connecting to the Base Station

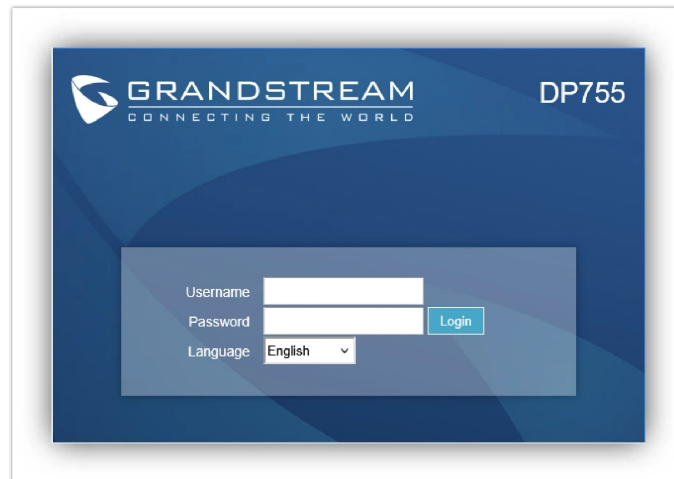

DP755 Web UI Login Page

Web GUI Languages

Currently, the DP755 series web GUI supports English, Czech, German, Spanish, French, Arabic, Hebrew, Italian, Russian, Netherlands, Japanese, Polish, Chinese Simple, Chinese Tradition, Korean, Portuguese, Slovakian, Serbian, Swedish, and Turkish.

Users can select the displayed language in the web GUI login page, or at the upper right of the web GUI after logging in



DP755 Web GUI Language

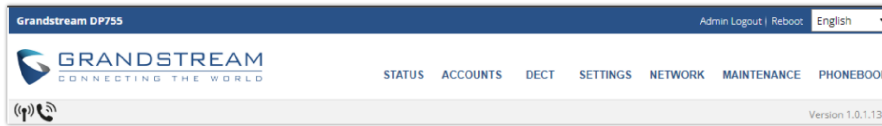

Icons Bar Shortcut

Users can find the icon bar right below the main menu of every page as displayed in following screenshot:



Icons Bar Shortcut

Please refer to the following table describing the use of each icon:

Icon	Description
	Refresh Button: Allows users to refresh the current page.
	Subscribe Button: Allows users to open the subscription.
	Paging Button: Allows users to page all the registered DP720/DP722/DP725/DP730/DP735 Handsets.

Saving the Configuration Changes

After users make changes to the configuration, pressing the Save button will save but not apply the changes until the Apply button on the top of the web GUI page is pressed. Users can instead directly press the **Save and Apply** button. We recommend rebooting or powering cycle the phone after applying all the changes.

For changes that require a reboot, a prompt will appear to restart the device after the configuration is applied.

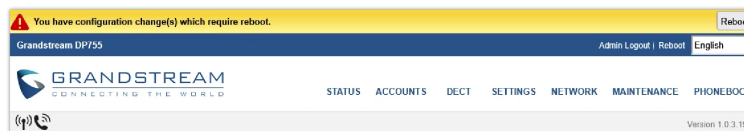

Reboot Prompt

Web UI Access Level Management

There are two default passwords for the login page:

User Level	Username	Password	Web Pages Allowed
End User Level	user	123	Only Status, Settings, and Maintenance
Administrator Level	admin	A random password is available on the sticker at the back of the unit.	All pages

- o The password is case sensitive with maximum length of 25 characters. When accessing the web GUI with end-user level, "Advanced Settings" page will be hidden.
- o When changing any settings, always SUBMIT them by pressing the **Save** or **Save and Apply** button on the bottom of the page. If using the **Save** button, after making all the changes, click on the **Apply** button on top of the page to submit. After submitting the changes in all the Web GUI pages, reboot DP755 to have the changes take effect if necessary; most of the options under the **Settings** page require reboot, but options under the **Accounts** and **Phonebook** pages do not.
- o By Default, the user level password is disabled, and can be enabled only by the administrator.
- o Once the initial Admin/user password is provided, you will be prompted to change it immediately.

Changing User Level Password

1. Access the Web GUI of your DP755 using the admin's username and password.
2. Press **Login** to access your settings.
3. Go to **Maintenance** → **Web/SSH Access**.
4. In the Web/SSH Access page, locate the User Password section:
 - o Type in your new user password in the New Password field.
 - o Type in again the same entered password in **Confirm Password** field.
5. Press **Save and Apply** to save your new setting.

The screenshot shows the 'Web Access' configuration page in the Grandstream Web GUI. The 'Admin Password' section is active, with input fields for 'Current Password', 'New Password', and 'Confirm Password'. A 'Save' button is located at the bottom of the form. The left sidebar shows navigation options like 'Upgrade and Provisioning', 'System', 'TR-069', 'Security Settings', 'Security', 'Trusted CA Certificates', 'Packet Capture', 'Factory Reset', and 'Tools'. The top right corner indicates 'Version 1.0.1.13'.

Changing User Level Password

Note

DO NOT USE the same password for both user and admin accounts.

Changing Admin Level Password

1. Access the Web GUI of your DP755 using the admin's username and password.
2. Press **Login** to access your settings.
3. Go to **Maintenance → Web/SSH Access**.
4. In **the** Web/SSH Access page, locate the Admin Password section:
 - Type in your new Admin Password in the **New Password** field.
 - Type in again the same entered password in **Confirm Password** field.
5. Press **Save and Apply** to save your new setting.

This screenshot is identical to the one above, showing the 'Web Access' configuration page with the 'Admin Password' section highlighted. It shows the 'Current Password', 'New Password', and 'Confirm Password' fields, along with a 'Save' button. The sidebar and top navigation are also visible.

Changing Admin Level Password

Note

DO NOT USE the same password for both user and admin accounts.

Changing HTTP / HTTPS Web Access Port

1. Access the Web GUI of your DP755 using the admin's username and password.
2. Press **Login** to access your settings.
3. Go to **Maintenance → Security Settings → Web/SSH**.
4. In **the** Web/SSH Settings page, locate HTTP / HTTPS Web Port field and change it to your desired/new HTTP / HTTPS port.
Note: By default, the HTTP port is 80 and HTTPS is 443.
5. Select the Web Access Mode depending on the desired protocol (HTTP or HTTPS).
6. Press **Save and Apply** to save your new setting.

Note

A reboot is required for this change to take effect.

Note

Selecting "Disabled" for Web Access Mode will disable web UI access.

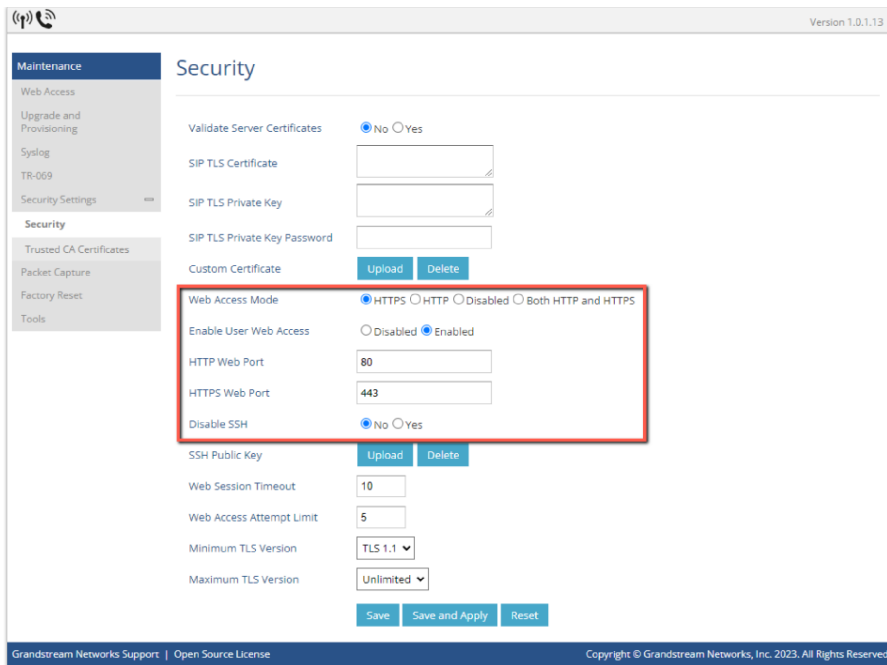

Web Access Port





Web Configuration Definitions

This section describes the options in the DP755 Web UI. As mentioned, you can log in as an administrator or an end user.

- **Status:** Display system info, network status, base and repeater status, account status, and line options.
- **Accounts:** Configure the accounts with general settings, network settings, SIP settings, audio settings, call settings, ring tones, and more.
- **DECT:** Configure DECT general settings, Account Assignments, and Handsets line settings.
- **Settings:** Configure ring tones and system features.
- **Network:** Configures the network settings such as OpenVPN Settings and SNMP Settings.
- **Maintenance:** Configure networks, upgrade and provisioning, web/SSH access, TR-069, security settings, date and time, and syslog.
- **Phonebook:** Manage phonebooks: global (XML or LDAP) and private (XML).

Status Page Definitions

Account Status	
Account	Displays list of configured accounts' names, from Account 1 to Account 10.
SIP User ID	Displays list of SIP user id registered.
SIP Server	Displays list of SIP Server.
SIP Registration	Shows the status of SIP registration. If the SIP account is successfully registered, it will display "YES" with green background. If the SIP account is not registered, it will display "NO" with red background.
Ringling Mode	Displays the HS mode configured for each account.
HS status table	<p>Illustrates both Handsets and SIP accounts statuses. Each column is dedicated to one HS; each row shows the status of the account on that HS:</p> <ul style="list-style-type: none"> ● Gray: HS is not configured to use this account. ● Green: HS is idle on this account. ● Green Blinking: HS is using this account. ● Red/Orange Blinking: HS is ringing on this account. Green Blinking: HS is using this account. ● Brown: The line is configured, but the handset is not subscribed. <p>For example, if accounts 1, 3 and 4 are assigned to HS3 with account 3 in use, the column for HS3 will have cell 3 with red icon, cells 1 and 4 with green icon, and cells 2 and 5 with gray icon.</p>
DECT Base Status	
Base Station Name	Displays name of base station. Default is DP755_[last 6 digits of MAC address].
Base DECT FW Version	Shows firmware version of base DECT.
Base DECT RF Region	Indicates region of base DECT RF.

Base DECT RFPI Address	Specifies DECT RFPI (Radio Fixed Part Identity) address which is a unique identity for the base.
Global Functions	Displays Global Information about upgrading handsets.
Handset	Displays Handset index.
Name	Displays Handsets names
IPEI	Indicates IPEI number of each Handsets; this is the unique identity for the Handsets. If the Handsets is in range, the IPEI will be displayed with a green background, otherwise, it will be displayed with a red background.
	<p>Illustrates battery status for each handset; it can be either:</p> <ul style="list-style-type: none"> • Fully charged :  • Not Fully charged :  • Low, needs to be charged or replaced:  • Charging: 
Page	Sends paging request to corresponding Handsets, which will receive incoming ring tone and “Paging” will be displayed on their LCD screens; this function helps you locate the Handsets.
Unsubscribe	Unsubscribes corresponding handset from DECT base station.
HS Firmware	Indicates Handsets’ firmware version number.
Upgrade	Shows Handsets upgrade status or trigger handset upgrade process.
Line Options	
Account	Account index.
SIP User ID	Displays the configured SIP User ID for the account.
DND	DND status of the account. Default No.
Forward	The unconditional forward number.
Busy Forward	The forward number for Call Forward Busy.
Delayed Forward	The no answer delayed forward number.
Network Status	
MAC Address	Shows Device ID in hexadecimal format. This is needed by network administrators for troubleshooting. The MAC address will be used for provisioning and can be found on the label on original box and on the label located on the bottom panel of the device.
IP Setting	Indicates used IP address mode: DHCP, Static IP or PPPoE.
IPv4 Address	Displays assigned IPv4 address. Example: 192.168.5.110
IPv6 Address	Displays assigned IPv6 address. Example: 0:0:0:0:ffff:c0a8:056e
OpenVPN® IP	Displays OpenVPN® IP address.
Subnet Mask	Displays assigned subnet mask. Example: 255.255.255.0
Gateway	Displays assigned default gateway. Example: 192.168.5.1
Primary DNS	Shows assigned Primary DNS server address. Example: 8.8.8.8
Secondary DNS	Shows assigned Secondary DNS server address. Example: 8.8.4.4
PPPoE Link Up	Indicates PPPoE connection status.

NAT Type	Displays the NAT type enabled.
NAT Traversal	Indicates the type of NAT for each account (20 accounts in total).
System Info	
Product Model	Displays product model info. Default is DP755.
Serial Number	Displays the device's serial number.
Part Number	Shows product part number. Example: 9610006512A (last 2 digits show HW version, in this example 12A for HW version 1.2A)
Certificate Type	Displays the Certificate type installed on the device.
Software Version	<p>Boot: Specifies Boot version.</p> <p>Core: Specifies Core version.</p> <p>Prog: Specifies Prog version, This is the main firmware release number, which is always used for identifying the software system of the DP755.</p> <p>CPE: Specifies CPE version (current version is 1.0.4.138)</p> <p>Handset: Specifies Handset firmware version.</p>
IP Geographic Information	<ul style="list-style-type: none"> ● City: Displays the city where the DP755 is located ● Language: Displays the language of the unit. ● Time Zone: Displays the Time Zone that the DP755 is on.
Special Feature	Displays whether the OpenVPN® support is enabled or not.
System Up Time	Indicates system uptime since last reboot.
System Time	Shows actual time and date according to your configuration.
Service Status	Reveals status of VoIP applications.
System Information	Gives the option to download System information
User Space	Shows User space used and the database status
Core Dump	Generates core dump by killing programs gs_cmb and gs_phone.

Status Page Definitions

Accounts Page Definitions

General Settings	
Account Active	Activates or deactivates SIP Account.
Account Name	Determines the name of the account, this account name can also be used in Handsets config provisioning for validation.
SIP Server	Configures SIP server IP address or domain name provided by VoIP service provider. This is the primary SIP server used to send/receive SIP messages from/to DP755.
Secondary SIP Server	Specifies failover SIP server IP address or domain name provided by VoIP service provider. This server will be used if the primary SIP server becomes unavailable.
Outbound Proxy	Specifies the IP address or domain name of an outbound proxy, a media gateway, or a session border controller. Used by DP755 for firewall or NAT penetration in different network environments. If symmetric NAT is detected, STUN will not work, and only the outbound proxy can correct the problem.
Backup Outbound Proxy	IP address or Domain name of the Secondary Outbound Proxy which will be used when the primary proxy cannot be connected.
SIP User ID	User account information, provided by your VoIP service provider.
Authenticate ID	SIP service subscriber's Authenticate ID is used for authentication. It can be identical to or different from the SIP User ID.
Authenticate Password	The account password required for the phone to authenticate with the SIP server before the account can be registered.
Name	The SIP server subscriber's name (optional) that will be used for Caller ID display (e.g., John Doe).
Voice Mail Access Number	Allows users to access voice messages by pressing the MESSAGE button on the phone. This value is usually the VM portal access number.

Network Settings	
DNS Mode	<p>Selects DNS mode to use for the client to look up server. Default is A Record.</p> <p>A Record: resolves IP Address of target according to domain name.</p> <p>SRV: DNS SRV resource records indicate how to find services for various protocols.</p> <p>NAPTR/SRV: Naming Authority Pointer according to RFC 2915.</p> <p>Use Configured IP: If selected, please fill in Primary IP, Backup IP 1 and Backup IP 2 to be used for server look up.</p>
Maximum Number of SIP Request Retries	<p>Specifies the maximum number of retries on SIP Requests.</p> <p>Default value is 2.</p>
DNS SRV Failover mode	<p>Configures the preferred method for DNS SRV failover.</p> <p>If "Default" is selected, the primary SIP server or Outbound Proxy will always be attempted first for all REGISTER and INVITE requests.</p> <p>If "Use current server until DNS TTL" is selected, the device will send all SIP messages to the current failover SIP server or Outbound Proxy until DNS times out.</p> <p>If "Use current server until no response" is selected, the device will send all SIP messages to the current failover SIP server or Outbound Proxy until there is no response.</p> <p>If "Use current server until fallback timer expires" is selected, the device will send all SIP messages to the current failover SIP server or Outbound Proxy until the fallback timer expires.</p>
Failback Timer	<p>Specifies the time interval (in minutes) that the device should continue to send SIP requests (REGISTER or INVITE) to the failover IP. Once it expires, the SIP requests will be sent to the preferred IP. The default value is 60 minutes, and the max value is 45 days.</p>
Register before DNS SRV failover	<p>When the DNS SRV Failover Mode is enabled, you can also choose to "Register before DNS SRV failover" that can waive the 3 failed tries, or still try 3 times then use the failover DNS.</p>
Primary IP	<p>Specifies primary IP address where the base sends DNS query to, when "Use Configured IP" is selected for DNS mode.</p>
Backup IP 1	<p>Specifies backup IP 1 address where the base sends DNS query to, when "Primary IP" is not responding.</p>
Backup IP 2	<p>Specifies backup IP 2 address where the base sends DNS query to, when "Backup IP 1" is not responding.</p>
NAT Traversal	<p>Enables/disables NAT traversal mechanism. If activated (by choosing "STUN") and a STUN server is also specified (Maintenance → Network Settings → STUN Settings); the base performs according to STUN client specification.</p> <p>Under this mode, embedded STUN client will detect if and what type of firewall/NAT is being used. If detected NAT is a Full Cone, Restricted Cone, or a Port-Restricted Cone, the base will use its mapped public IP address and port in all of its SIP and SDP messages. If NAT Traversal field is set to "Keep Alive", the base will periodically (every 20 seconds) send a blank UDP packet (with no payload data) to SIP proxy to keep the "ping hole" on the NAT open.</p>
Proxy-Require	<p>Determines a SIP Extension to notify the SIP server that the base is behind a NAT/Firewall.</p>
Use SBC	<p>Indicates whether or not a SBC server is used, if users want to work under SBC associated with 3CX, they should enable this feature to have better communication with the server.</p>
SIP Settings	
Basic Settings	
TEL URI	<p>Indicates E.164 number in the "From" header by adding "User=Phone" parameter or using "Tel:" in SIP packets, if the base has an assigned PSTN Number.</p> <p>Disabled: Will use "SIP User ID" information in the Request-Line and "From" header.</p> <p>Disabled: Will use "SIP User ID" information in the Request-Line and "From" header.</p> <p>Enabled: "Tel:" will be used instead of "sip:" in the SIP request.</p> <p>Please consult your carrier before changing this parameter. The default is Disabled.</p>
SIP Registration	<p>Controls whether to send SIP REGISTER messages to the proxy server. Device may not be able to make/receives calls if disabled. Default is Yes.</p>
Unregister on Reboot	<p>Controls whether to clear SIP user's information by sending an un-register request to the proxy server. The un-registration is performed by sending a REGISTER message with the "Contact" header set to * and Expires=0 parameters to the SIP server. This will unregister all SIP accounts under the concerned account. The default value is "No".</p>
Register Expiration	<p>Specifies the frequency (in minutes) when the phone refreshes its registration with the specified registrar. The maximum value is 64800 (about 45 days).</p> <p>The default value is 60 minutes.</p>
Subscribe Expiration	<p>Specifies the frequency (in minutes) when the phone refreshes its subscription with the specified registrar. The maximum value is 64800 (about 45 days).</p> <p>The default value is 60 minutes.</p>
Reregister Before Expiration	<p>Sends re-register request after specific time (in seconds) to renew registration before the previous registration session expires.</p>

Enable OPTIONS Keep Alive	Enables OPTIONS Keep Alive, to check SIP server. Default is No.
OPTIONS Keep Alive Interval	Time interval for OPTIONS Keep Alive feature in seconds. Range of values is 1–64800. Default is 30.
OPTIONS Keep Alive Max Lost	A maximum number of lost packets for the OPTIONS Keep Alive feature before the phone sends a re-registration. Range of values 3-10. The default is 3.
Enable TCP Keep Alive	Ensures continuous monitoring of the connection with connected devices, promptly detecting interruptions and allowing for quick re-establishment of the connection for reliable communication. Enabled by Default
Local SIP Port	The parameter specifies the local ports that the base station uses for sending and receiving SIP packets. By default, Account 1 uses port 5060, Account 2 uses 5062, Account 3 uses 5064, and Account 4 uses 5066, with increments of two for each subsequent account up to Account 20.
SIP Registration Failure Retry Wait Time	Sends re-register request after specific time (in seconds) when registration process fails. Maximum interval is 3600 seconds (1 hour). Default is 20 seconds.
SIP T1 Timeout	Defines T1 timeout value. It is an estimate of the round-trip time between the client and server transactions. For example, the base station will attempt to send a request to a SIP server. The time it takes between sending out the request to the point of getting a response is the SIP T1 timer. If no response is received the timeout is increased to (2*T1) and then (4*T1). Request re-transmit retries would continue until a maximum amount of time defined by T2. Default is 0.5 seconds.
SIP T2 Timeout	Identifies maximum retransmission interval for non-INVITE requests and INVITE responses. Retransmitting and doubling of T1 continues until it reaches T2 value. Default is 4 seconds.
SIP Transport	Selects transport protocol for SIP packets; UDP or TCP or TLS. Make sure your SIP server or network environment supports SIP over the selected transport method. Default is UDP.
SIP Listening Mode	Determines whether or not to listen to multiple SIP protocols. Dual will listen to TCP when UDP is selected while Dual (Secured) will listen to TLS/TCP when UDP is selected. If TCP or TLS/TCP is selected, UDP will be listened to. Set to Transport Only by Default.
SIP URI Scheme When Using TLS	Specifies if “sip” or “sips” will be used when TLS/TCP is selected for SIP Transport. The default setting is “sips”.
Use Actual Ephemeral Port in Contact TCP/TLS	Defines whether the actual ephemeral port in contact with TCP/TLS will be used when TLS/TCP is selected for SIP Transport. If set to No, these port numbers will use the permanent listening port on the phone. Otherwise, they will use the ephemeral port for the connection. The default setting is “No”.
Outbound Proxy Mode	In Outbound Proxy mode, SIP messages can include the outbound proxy in the route header, or they can be directly sent to the outbound proxy without the route header. the options to set are: in route, not in route, and always send to. Set to in-route by default.
Support SIP Instance ID	Adds “SIP Instance ID” attribute to “Contact” header in REGISTER request as defined in IETF SIP outbound draft. Default is Yes.
SUBSCRIBE for MWI	Sends periodic “SUBSCRIBE” requests (depends on “Register Expiration” parameter) for message waiting indication service. Default is No.
SUBSCRIBE for Registration	When set to "Yes", a SUBSCRIBE for Registration will be sent out periodically.
Enable 100rel	Appends “100rel” attribute to the “required” header of the initial signaling messages. Default is No.
Callee ID Display	When the phone is set to 'Auto,' the callee ID in the 180 Ringing will be updated in the order of P-Asserted Identity Header, Remote-Party-ID Header, and To Header. If set to 'Disabled,' the callee ID will show as 'Unavailable.' Choosing 'To Header' will keep the caller ID unchanged and display it as per the To Header
Caller ID Display	When configured as "Auto," the phone will search for the caller ID in the order of P-Asserted Identity Header, Remote-Party-ID Header, and From Header in the incoming SIP INVITE. If set to "Disabled," all incoming calls will be shown as "Unavailable."
Add Auth Header On Initial REGISTER	Adds “Authentication” header with blank “nonce” attribute in the initial SIP REGISTER request. Default is No.
Allow SIP Reset	Allows to reset the devices directly through SIP Notify. If “Allow SIP Reset” is set to “YES”, then the base receives the NOTIFY from the SIP server with Event: reset, the base should perform a factory reset after the authentication. The authentication in this case can be either with: The admin password if no SIP account is configured on the base. With the credentials of the SIP account if configured on the base. By default, it is set to "No".

Ignore Alert-Info Header	This option is used to configure default ringtone. If set to "Yes", configured default ringtone will be played. The default setting is No.
Custom SIP Headers	
Use Privacy Header	Controls whether the Privacy Header will be present in SIP INVITE message. Default is Default.
Use P-Preferred-Identity Header	Controls whether PPI Header will be present in SIP INVITE message. Default is Default.
Use P-Access-Network-Info Header	Use P-Access-Network-Info header in SIP request. Enabled by Default.
Use P-Emergency-Info Header	Use P-Emergency-Info header in SIP request. Enabled by Default.
Use MAC Header	When set to "Only for REGISTER," the MAC header will only be included in SIP messages for registration and unregistration. If set to "Yes to All SIP," the MAC header will be included in all outgoing SIP messages. When set to "No," the MAC header will not be present in any outgoing SIP message.
Add MAC in User-Agent	When set to "Yes except REGISTER," the phone's MAC address will be added to the User-Agent header in all outgoing SIP messages, except for REGISTER and UNREGISTER. If set to "Yes to All SIP," the phone's MAC address will be included in the User-Agent header of all outgoing SIP messages. When set to "No," the phone's MAC address will not appear in the User-Agent header of any outgoing SIP messages.
Advanced Features	
PUBLISH for Presence	Enables Presence feature on the phone. Disabled by Default.
Omit charset=UTF-8 in MESSAGE	Determines whether the base station sends SIP MESSAGE requests without including the "charset=UTF-8" declaration (when enabled) or includes it (when disabled) for specifying the character encoding of the text in the message. Disabled by Default.
Feature Key Synchronization	When enabled, call features like DND, call forward, call waiting will be synchronized between the server and the phone. It will use NOTIFY to send the status in XML content to server and accept the NOTIFY from the server. This feature following the Broadsoft and MetaSwitch standard. Any server following the same standard will be compatible with this feature.
Special Feature	Selects Soft switch vendors' special mode. Examples of vendors: Nortel MCS, Broadsoft, CBCOM, RNK, Sylantro, Huawei IMS, Phonepower, and UCM Call Center. The default is Standard.
Session Timer	
Enable Session Timer	Enables/Disables the Session Timer Support. Default is Yes.
Session Expiration	Enables periodic refresh of SIP session via a SIP request (UPDATE, or re-INVITE). When the session interval expires and there is no refresh via an UPDATE or re-INVITE message, the session will be terminated. Session Expiration is the time at which the session is considered timed out, if no successful session refresh transaction occurs beforehand. Default is 180 seconds.
Min-SE	Defines Minimum session expiration (in seconds). Default is 90 seconds.
Caller Request Timer	Uses session timer when making outbound calls if remote party supports it. Default is No.
Callee Request Timer	Uses session timer when receiving inbound calls with session timer request. Default is No.
Force Timer	It uses a session timer even if the remote party does not support this feature. Selecting "No" will enable session timer only when the remote party supports it. The default is No. To turn off Session Timer, select "No" for Caller Request Timer, Callee Request Timer, and Force Timer.
UAC Specify Refresher	Specifies which end will act as refresher for outgoing calls: UAC: The base station acts as the refresher. UAS: Callee or proxy server act as the refresher. Default is Omit.
UAS Specify Refresher	Specifies which end will act as a refresher for incoming calls: UAS: The base station serves as the refresher. UAC: Callee or proxy server act as the refresher. The default is Omit.
Force INVITE	Uses INVITE message to refresh the session timer. Default is No.

Security Settings	
Check Domain Certificates	Defines whether the domain certificates will be checked when TLS/TCP is used for SIP Transport. Disabled by Default
Validate Certificate Chain	Validates certificate chain when TLS/TCP is configured. Disabled by Default.
Validate Incoming Messages	Defines whether incoming messages will be validated or not. Default is No.
Check SIP User ID for Incoming INVITE	Checks SIP User ID in the Request URI of incoming INVITE; if it doesn't match the base SIP User ID, the call will be rejected. Direct IP calling will also be disabled. Default is No.
Accept Incoming SIP from Proxy Only	Checks SIP address of the Request URI in the incoming SIP message; if it doesn't match SIP server address of the account, the call will be rejected. Default is No.
Authenticate Incoming INVITE	Challenges the incoming INVITE for authentication with SIP 401 Unauthorized message. Default is No.
Audio Settings	
Preferred Vocoder- Choice x	Configures vocoders in a preference list (up to 8 preferred vocoders) that will be included with same order in SDP message. Vocoder types are G.711 A-/U-law, G.722, G.726-32, G.723, G.729, iLBC and OPUS
Use First Matching Vocoder in 200OK SDP	Includes only the first matching vocoder in its 200OK response, otherwise it will include all matching vocoders in same order received in INVITE. Default is No.
Codec Negotiation Priority	Configures the phone to use which codec sequence to negotiate as the callee. When set to "Caller", the phone negotiates by SDP codec sequence from received SIP Invite; When set to "Callee", the phone negotiates by audio codec sequence on the phone. The default setting is "Callee".
Disable Multiple m line in SDP	If enabled, the phone always responds to 1 m line in SDP regardless multiple m lines are offered. Disabled by Default.
SRTP Mode	Selects the SRTP mode to use ("Disabled", "Enabled but not forced", "Enabled and forced", "Follow SIP Transport", or "Optional"). <ol style="list-style-type: none"> Disabled: SRTP is not used at all. Voice communication will be transmitted without encryption or authentication, which may pose a security risk. Enabled and forced: Ensures that SRTP is always used for voice communication. The base station enforces the use of SRTP and requires connected devices to support it. If a device doesn't support SRTP, the call may be rejected or the communication won't be established. Follow SIP Transport: When "Follow SIP Transport" is chosen, the SRTP protocol follows the transport protocol specified in the SIP signaling messages to determine when to start and stop the encryption and decryption of the RTP traffic. Optional: This option allows SRTP to be used, but it is not mandatory. The base station can negotiate with the devices to determine whether to enable SRTP. If SRTP is agreed on, the communication will be encrypted and authenticated. If not, the communication will proceed without SRTP. The default is Disabled.
SRTP Key Length	The cipher method / key length to use if SRTP is enabled.
Crypto Life Time	Adds crypto lifetime header to SRTP packets. The default is Yes.
Symmetric RTP	Defines whether symmetric RTP is supported or not. The default setting is "No".
Silence Suppression	Allows detection of the absence of audio and conserves bandwidth by preventing the transmission of "silent packets" over the network. The default is No.
Jitter Buffer Type	Selects either Fixed or Adaptive based on network conditions. Set to Adaptive by Default.
Jitter Buffer Length	Selects Low, Medium, or High based on network conditions. Set to 300ms by Default
Voice Frames per TX	Transmits a specific number of voice frames per packet. Default is 2; increases to 10/20/32/64 for G711/G726/G723/other codecs respectively.
G723 Rate	Selects encoding rate for G723 codec, the options are: <ul style="list-style-type: none"> ● 6.3kbps encoding rate ● 5.3kbps encoding rate The default value is 5.3kbps encoding rate
G726-32 Packing Mode	Defines G726-32 packing mode ("ITU" or "IETF"). Default is ITU.

iLBC Frame Size	Specifies iLBC packet frame size (20ms or 30ms). Default is 20ms.
iLBC Payload type	Determines payload type for iLBC. The valid range is between 96 and 127. Default is 97.
OPUS Payload Type	Determines OPUS payload type. The valid range is between 96 and 127. Default is 123.
DTMF Payload Type	Configures the payload type for DTMF using RFC2833. Cannot be the same as iLBC or OPUS payload type
Send DTMF	Specifies the mechanism to transmit DTMF digits. you can choose to do it in-audio, via RTP(RFC2833), or via SIP INFO
Call Settings	
Dial Plan Prefix	Configures the prefix added to the dialed number.
Dial Plan	<p>Dial Plan Rules: Accept Digits : +,1,2,3,4,5,6,7,8,9,0, *, #, A,a,B,b,C,c,D,d ; Grammar: x – any digit from 0-9;xx+ – at least 2-digit number; xx – exactly 2-digit number; ^ – exclude; . – wildcard, matches one or more characters [3-5] – any digit of 3, 4, or 5; [147] – any digit 1, 4, or 7; <2=011> – replace digit 2 with 011 when dialing <=1> – add a leading 1 to all numbers dialed, vice versa will remove a 1 from the number dialed – or Example 1: {[369]11 1617xxxxxx} – Allow 311, 611, 911, and any 10-digit numbers of leading digits 1617 Example 2: {^1900x+ <=1617>xxxxxx} – Block any number with leading digits 1900 and add prefix 1617 for any dialed 7-digit numbers Example 3: {1xxx[2-9]xxxxxx <2=011>x+} – Allow any length of number with leading digit 2 and 10 digit-numbers of leading digit 1 and leading exchange number between 2 and 9; If leading digit is 2, replace leading digit 2 with 011 before dialing. Default: Outgoing – {x+} Example of a simple dial plan used in a Home/Office in the US: { ^1900x. <=1617>[2-9]xxxxxx 1[2-9]xx[2-9]xxxxxx 011[2-9]x. [3469]11 +x+ } Explanation of example rule (reading from left to right): ^1900x. – prevents dialing any number starting with 1900 <=1617>[2-9]xxxxxx – allows dialing to local area code (617) numbers by dialing 7 numbers and the 1617 area code will be added automatically 1[2-9]xx[2-9]xxxxxx – allows dialing to any US/Canada Number with 11 digits length 011[2-9]x. – allows international calls starting with 011 [3469]11 – allow dialing special and emergency numbers 311, 411, 611 and 911 +x+ – allow dialing any digit with leading + sign; example: +16175669300 Note: In some cases, the user wishes to dial strings such as *123 to activate voice mail or other application provided by the service provider. In this case * should be predefined inside the dial plan feature. An example dial plan will be { *x+ } which allows the user to dial * followed by any length of numbers.</p>
Bypass Dial plan	Enable/Disable the dial plan check while making outgoing calls. The default setting is “No”.
On Hold Reminder Tone	Supports to disable or enable “On Hold Reminder Tone” to play a reminder tone when a call is on hold.
Call Log	Configure the level of call logs or disable the call log. By default, it is set to Log all calls.
Send Anonymous	Sets “From”, “Privacy” and “P_Asserted_Identity” headers in outgoing INVITE message to “anonymous”, blocking caller ID. Default is No.
Anonymous Call Rejection	Rejects incoming calls with anonymous caller ID with “486 Busy here” message. Default is No.
Refer-To Use Target Contact	If set to “Yes”, the “Refer-To” header uses the transferred target’s Contact header information for attended transfer.
Transfer on Conference Hangup	Defines whether the call is transferred to the other party if the conference initiator hangs up.
Blind Transfer Wait Timeout	Defines the timeout (in seconds) for waiting SIP frag response in blind transfer. Valid range is 30 to 300.
Key As Send	Pressing selected key will immediately dial out. Pound “#” is the default selection.
RFC2543 Hold	If yes, c=0.0.0.0 will be used in INVITE SDP for hold. Disabled By Default.

Music On Hold URI	Defines the URI for the server from which the DP75x device will retrieve the music on hold file.
Allow Unsolicited REFER	<p>The "Allow Unsolicited REFER" option allows the handset to accept, deny, or require authentication for external REFER requests coming from the SIP server, these requests automatically transfer calls to other parties without user intervention, the available options are:</p> <ul style="list-style-type: none"> • Disabled: The handset rejects any unsolicited REFER requests. It won't allow call transfers unless initiated by the user. • Enabled: The handset accepts unsolicited REFER requests without any authentication, which allows the automatic call transfer. • Enabled/Force Auth: The phone accepts unsolicited REFER requests, but only after the sender provides valid SIP authentication credentials. <p>The default value is Disabled.</p>
Match Incoming Caller ID	<p>Specifies matching rules with number, pattern or Alert Info text. When the incoming caller ID or Alert Info matches the rule, the phone will ring with selected distinctive ringtone.</p> <p>Matching rules:</p> <ul style="list-style-type: none"> • Specific caller ID number. For example, 8321123; • A defined pattern with certain length using x and + to specify, where x could be any digit from 0 to 9. Samples: xx+ : at least 2-digit number; xx : only 2-digit number; [345]xx: 3-digit number with the leading digit of 3, 4 or 5; [6-9]xx: 3-digit number with the leading digit from 6 to 9. • Alert-Info text <p>Users could configure the matching rule as certain text (e.g., priority) and select the custom ring tone mapped to it. The custom ring tone will be used if the phone receives SIP INVITE with Alert-Info header in the following format: Alert-Info: <http://127.0.0.1>; info=priority Selects the distinctive ringtone for the matching rule. When the incoming caller ID or Alert Info matches the rule, the phone will ring with the selected ring.</p> <p>Note: Alert info can also be input as a string.</p>
Ring Timeout	Stops ringing when incoming call is not answered within a specific period of time. Default is 60 seconds.
Intercom Settings	
Allow Auto Answer by Call-Info/Alert-Info	If set to "Yes", the phone will automatically turn on the speaker phone to answer incoming calls after a short reminding beep, based on the SIP Call-Info/Alert-Info header sent from the server/proxy. Enabled by Default.
Allow Barging by Call-Info/Alert-Info	When enabled, the phone will automatically put the current call on hold and answer the incoming calls based on the SIP Call-Info/Alert-Info header sent from the server/proxy. However, if the current call was answered based on the SIP Call-Info/Alert-Info header, then all other incoming calls with SIP Call-Info/Alert-Info headers will be rejected automatically. Disabled by Default.
Custom Alert-Info for Auto Answer	Used exclusively to match the contents of the Alert-Info header for auto answer. The default auto answer headers will not be matched if this is defined.
Feature Codes	
Enable Local Call Features	When enabled, Do No Disturb, Call Forwarding and other call features can be used via the local feature codes on the phone. Otherwise, the provisioned feature codes from the server will be used. User-configured feature codes will be used only if server-provisioned feature codes are not provided. Enabled By Default
Account Swap	
Swap Account Settings	Swap configurations between two accounts.

Accounts Page Definitions

DECT Page Definitions

General Settings	
Base Station Name	Displays the name of the base station. The default is DP755[last 6 digits of MAC address].
Admin PIN Code	Configures admin PIN code for authentication. Default is 0000
Enable Repeater Mode	Enables the base station repeater mode to associate with available repeaters. Once enabled the base station starts searching for nearby repeaters and opens a subscription to associate with the available repeaters. This option requires rebooting the base station to take effect. The default is No.
Enable Repeater Management	Enables base station network management of discovered and paired repeaters. Once enabled, users need first to reboot the base station to take effect, then login on the web UI and browser to Status page, a new tab "DECT Repeater Status" will be available to display discovered and paired devices and also allowing users to associate / dissociate repeaters and also access their web GUI. Default is No.

DECT PTT Silence Timer	Sets timeout for PTT call (in minutes) if no handset unmutes. If set to 0, this timer will be disabled.
Collapse Call History	Enables collapsing of like call logs into a single entry for display on handset. Calls will only be combined if of the same type (missed, incoming accepted, or outgoing) and with the same remote party.
Clear Call Logs	Deletes call history logs of all handsets from base station
Account Assignment	
SIP User ID	displays the SIP User ID assigned to the account number.
Ringling Mode	Specifies the ringing mode for the account, the options are: <ul style="list-style-type: none"> • Parallel mode: all phones ring concurrently; after one phone answers, the remaining available phones can make new calls. • Circular mode: all phones ring sequentially, starting with the phone after the one which rang last. • HS x: only the selected handset will ring. The default ringing mode is "Parallel".
HS1-HS10	Within the handset matrix, you can designate specific handsets to ring for each SIP extension.
Handset Settings (1-10)	
Handset Name	Displays the handset name.
Enable Auto Answer	Enables / disables auto answer of incoming calls to handset. Default setting is No.
Enable Mute for Auto Answer	Enables/disables auto mute right after the call been answer, this can be configured by either the handset GUI or Web UI.
Enable Off hook on Cradle Pickup	Enables / disables off hook of handset when picked up from cradle. Default setting is No.
Enable on a hook on Cradle Reposition	Enables / disables on hook of handset when repositioned on cradle. Default setting is No.
Enable Mute as DND	Enables users to activate/deactivate Do Not Disturb mode by pressing the Mute Key in idle screen. Default setting is Yes.
Disable Conference	Enables / disables the conference option on this handset. Default setting is No.
Disable Transfer	Enables / disables transfer option on this handset. Default setting is No.
Disable Busy Tone on Remote Disconnect	Enables / disables the busy tone heard in the handset when call is disconnected remotely.
Disable Call Waiting Tone	Disables playing call waiting tone during active call when receiving a second incoming call. The CWCID will still be displayed. Default is No.
Play warning tone for Auto Answer Intercom	Allows to play a warning tone for auto answer for protect the privacy. This setting can be configured by either the handset GUI or the Web UI.
No Key Entry Timeout	Initiates the call within this time interval if no additional key entry during dialing stage. Default is 4 seconds.
Custom Ringtone	Assigns custom ringtone to specific handset from the ringtones available on the base station. It takes up to 10 ringtone files which have be named as ring1.bin to ring10.bin, and you can assign one ringtone to each handset. Default is Disabled.
Time Format	Set the displayed Time Format on handsets to 12 hours or 24 hours. Default is 12hr.
Date Format	Set the displayed Date Format on handsets.
Handset Phonebook	Selects the phonebook for the handset , you can select from the 10 XML phonebooks available under Phonebook => Private Phonebook Setting.
Offhook Auto-dial	Enables automatic dialing of a predefined number when a handset goes off-hook (lifted from its cradle) without any user input.
Off-hook Auto Dial Delay	Sets the time delay before initiating automatic dialing when a handset goes off-hook (lifted from its cradle) without user input.

DECT Page Definitions

Settings Page Definitions

Settings => General Settings

Local RTP Port	This parameter defines the local RTP port used to listen and transmit. The valid range is 1024 to 65400 and it must be even. Default is 5004
Local RTP Port Range	This parameter defines the range of local RTP ports from 24 to 10000. Default is 200
Use Random Port	When set to "Yes", this parameter will force random generation of both the local SIP and RTP ports. Enabled by Default.
Keep-Alive Interval	Specifies how often the phone sends a blank UDP packet to the SIP server in order to keep the "ping hole" on the NAT router open. The default is 70 minutes.
Use NAT IP	The NAT IP address used in SIP/SDP messages. It should ONLY be used if required by your ITSP.
STUN server	The IP address or Domain name of the STUN server. Only non-symmetric NAT routers work with STUN.
Delay Registration	It config the specific time that the account will be registered after booting up. Default is 0.
Test Password Strength	Only Allow password with some constraints to ensure better security. Disabled by Default.
Settings => External Service	
Order	Displays the order of the service. (1 – 10)
Service Type	Specifies the service's type. Two options are available: None or GDS. The default setting is None. Note: The DP755 supports up to 10 GDS items. For more details, refer to Facility Access Systems
Account	Specifies the account on which the service will be applied.
System Identification	Specifies the name to identify the service.
System Number	Specifies the system number, in case the service type option is set to GDS, the system number is the SIP user ID configured on GDS37xx, or the IP address of the GDS37xx itself if it's using IP call.
Access Password	Determines the access password, in case the service type option is set to GDS, the access password is the one configured on "Remote PIN to Open the Door" field on GDS37xx settings.
Settings => Call Features	
Disable Direct IP Call	Enables/Disables Direct IP Call feature. Disabled by Default
Enable DND Feature	Enables/Disables DND Call feature. Enabled by Default. If set to "No", a user cannot turn on Do Not Disturb feature via MUTE key, or menu on LCD
Do Not Escape '#' as %23 in SIP URI	Replaces # by %23 for some special situations.
Return Code When Refusing Incoming Call	When refusing the incoming call, the phone will send the selected type of SIP message to the call.
Return Code When Enable DND	When DND is enabled, the phone will send the selected type of SIP message. the options are: <ul style="list-style-type: none"> ● Busy(486) ● Temporarily Unavailable(480) ● Not Found(404) ● Decline(603) By default, it is set to Temporarily Unavailable(480)
User-Agent Prefix	Configure the prefix value in the User-Agent header.
SIP User-Agent	Configures the SIP User-Agent header. When left blank, the default User-Agent is used. (example => User-Agent: Grandstream DP755 1.0.3.11)
In-call Dial Number on Pressing Transfer Key	Configures the number to be dialed as DTMF during a call when pressing the TRANSFER button.
Settings => PTT/Multicast	

PTT multicast address	Defines the multicast address used for the Push-to-talk communication. the Multicast address should contain the IP Address and the port number.
PTT Config	
PTT	Enables/Disables the PTT feature.
Default Channel	Sets the default channel for PTT. When pressing and holding the PTT button, PTT will be initiated using the default channel. Default channel is "channel 1"
Priority Channel	Sets priority channel for PTT. PTT received on priority channel will take precedence over active PTT on normal channel. The valid range is 0-25, and default value is 24th channel
Emergency Channel	Sets emergency channel for PTT. Emergency channel has the highest priority. PTT using emergency channel will take precedence over PTT on priority or normal channel. Please note PTT to emergency channel will not be rejected even when device has enabled DND. the default channel is channel 25.
Caller ID	Set Caller ID displayed on the call interface during a PTT call.
PTime (ms)	Sets payload size for PTT in milliseconds, the default value is 30ms.
Audio Codec	Sets audio codec for PTT. Default is PCMU
Channel Config (1-25)	<p>The user can manually configure the options that will be included in each channel individually, the options are:</p> <ul style="list-style-type: none"> • Available • Transmit • Subscribe • Join channel
Settings => Preferences	
Date and Time	
NTP Server	Defines the URL or IP address of the NTP server. The phone may obtain the date and time from the server.
Secondary NTP Server	Defines the URL or IP address of the secondary NTP server. The phone may obtain the date and time from the server.
NTP Update Interval	The time interval for updating time from the NTP server. Valid time value is in between 5 to 1440 minutes. Default is 1440 minutes.
Allow DHCP Option 42 to override NTP server	When enabled, DHCP Option 42 will override the NTP server if it's set up on the LAN.
Allow DHCP Option 2 to Override Time Zone Setting	Allows device to get provisioned for Time Zone from DHCP Option 2 in the local server. Enabled by Default.
Time Zone	Configures the date/time used on the phone according to the specified time zone. Enabled by Default.
Self-Defined Time Zone	This parameter allows the users to define their own time zone. For syntax and examples, please refer to user manual.
Ringtone	
System Ring Cadence	Sets ring cadences for all incoming calls. Syntax: c=on1/off1-on2/off2-on3/off3;) Default is set to c=2000/4000; (US standards) on1 is the period of ringing ("On time" in "ms") while off1 is the period of silence. Up to three cadences are supported.
Call Progress Tones	<p>Configures tone frequencies according to user preference. By default, the tones are set to North American frequencies. Frequencies should be configured with known values to avoid uncomfortable high pitch sounds. ON is the period of ringing ("On time" in "ms") while OFF is the period of silence. In order to set a continuous ring, OFF should be zero. Otherwise, it will ring ON ms and a pause of OFF ms and then repeats the pattern.</p> <ul style="list-style-type: none"> • "Dial tone" • "Ring back tone" • "Busy tone" • "Call-Waiting tone" <p>Please refer to the document below to determine your local call progress tones: http://www.itu.int/ITU-T/inr/forms/files/tones-0203.pdf</p>
Settings => Voice Monitoring	
Session Report	

VQ RTPC-XR Session Report	When enabled, phone will send a session quality report to the central report collector at the end of each call. Disabled by Default.
Interval Report	
VQ RTPC-XR Interval Report	When enabled, phone will send a session quality report to the central report collector at the end of each call. Disabled by Default.
VQ RTPC-XR Interval Report Period	Configure the interval (in seconds) of phone sending an interval quality report to the central report collector periodically throughout a call. Default is 20 seconds
Alert Report	
Warning Threshold for Moslq	Configure the threshold value of the listening MOS score (MOS-LQ) multiplied by 10. The threshold value of MOS-LQ causes the phone to send a warning alert quality report to the central report collector. The default is 0.
Critical Threshold for Moslq	Configure the threshold value of the listening MOS score (MOS-LQ) multiplied by 10. The threshold value of MOS-LQ causes the phone to send a critical alert quality report to the central report collector. The default is 0.
Warning Threshold for Delay	Configure the threshold value of the one-way delay (in milliseconds) that causes the phone to send a warning alert quality report to the central report collector. The default is 0.
Critical Threshold for Delay	Configure the threshold value of one-way delay (in milliseconds) that causes the phone to send a critical alert quality report to the central report collector. The default is 0.

Settings Page Definitions

Network Page Definitions

Network Settings – Basic Settings	
Internet Protocol	Selects which Internet protocol to use. When both IPv4 and IPv6 are enabled, phone attempts to use preferred protocol first and switches to the other choice if it fails. Set to IPv4 Only by Default.
IPv4 Address	Select IP address mode (DHCP, Static IP, or PPPoE) for DP755 Base Station.
Hostname (Option 12)	Specifies the name of the client. The name may or may not be qualified with the local domain name. This field is optional but may be required by ISP.
Vendor Class ID (Option 60)	Exchanges vendor class IDs by clients and servers to convey particular configuration or other identification information about a client. The default is Grandstream DP755.
DNS Server 1	Preferred DNS Server
DNS Server 2	Enter DNS Server 2 when static IP is used.
Preferred DNS Server	Specifies preferred DNS server to use when DHCP, PPPoE, or Static mode is set.
IPv6 Address	The IPv6 address that is obtained on the phone. it can be set to be auto-configured (DHCP), or statically configured.
Full Static	Defines the Static IPv6 Address, and the IPv6 Prefix length
Prefix Static	Defines the IPv6 Prefix (64 bits).
DNS Server 1	Enter DNS Server 1 when static IP is used in IPv6 format.
DNS Server 2	Enter DNS Server 2 when static IP is used in IPv6 format.
Preferred DNS Server	Specifies preferred DNS server to use when DHCP, PPPoE or Static mode is set in IPv6 format.
Network Settings – Advanced Settings	
802.1X Mode	Enables/Disables 802.1X mode. To enable this mode, you should select EAP-MD5, EAP-TLS, or EAP-PEAPv0/MSCHAPv2. The default is disabled.
802.1X Identity	Configures the identity for 802.1X mode.
MD5 Password	Determines the MD5 password for 802.1X mode.

802.1X CA Certificate	Uploads / deletes the 802.1X CA certificates.
802.1X Client Certificate	Uploads / Deletes the 802.1X Client Certificates.
HTTP Proxy	Specifies the HTTP proxy URL for the phone to send packets to. The proxy server will act as an intermediary to route the packets to the destination.
HTTPS Proxy	Specifies the HTTPS proxy URL for the phone to send packets to. The proxy server will act as an intermediary to route the packets to the destination.
Bypass Proxy For	Enter host names that do not require a proxy to reach. Those names should be separated by commas.
Layer 3 QoS for SIP	Defines the Layer 3 QoS parameter for SIP. This value is used for IP Precedence, Diff-Serv, or MPLS. The default value is 26.
Layer 3 QoS for RTP	Defines the Layer 3 QoS parameter for RTP. This value is used for IP Precedence, Diff-Serv, or MPLS. The Default value is 46
Enable DHCP VLAN	Enable auto-configure for VLAN settings through DHCP. Disabled by Default.
Enable Manual VLAN Configuration	Assigns the priority value of the Layer 2 QoS packets. Valid range is 0 to 7. Enabled by Default.
Layer 2 QoS 802.1Q/VLAN Tag	Sets layer 2 QoS 802.1Q/VLAN tag. Default is 0.
Layer 2 QoS 802.1p Priority Value	Sets layer 2 QoS 802.1p priority value for SIP signaling.
Enable CDP	Enable/Disable the CDP (Cisco Discovery Protocol). Enabled by Default.
Enable LLDP	Activates LLDP (Link Layer Discovery Protocol). Enabled by Default. The default is 0.
LLDP TX Interval	Defines LLDP TX Interval (in seconds). Valid range is 1 to 3600. Default value is 60.
Maximum Transmission Unit (MTU)	Defines the MTU in bytes. Default is 1500.
Network Settings – Management Virtual IP Address Settings	
Management Virtual IP address	Enable or disable the management virtual IP address. Disabled by default.
Management Access	<p>Allow management of the device through virtual IP address or both actual IP and virtual IP addresses, you can choose one of the two options:</p> <ol style="list-style-type: none"> Management Virtual IP Address only: In this scenario, the device is accessible for management purposes (configurations, monitoring, updates, etc.) solely through a virtual IP address. This means that regardless of the physical IP address of the device, users interact with it using the virtual IP address. This approach is often used for enhancing flexibility and redundancy in network management. Both actual IP and virtual IP addresses: This option allows management of the device through both its actual (physical) IP address and a virtual IP address. Users have the flexibility to choose either the physical IP address or the virtual one to access and manage the device. Having both options can be useful in scenarios where redundancy and failover mechanisms are crucial. It ensures that even if the physical IP address becomes inaccessible or changes, administrators can still manage the device through the virtual IP address. <p>Set to "Management Virtual IP Address only" by Default</p>
SNMP Through Management Interface	Enable or disable snmp through the management interface. Disabled by default.
TR069 Through Management Interface	Enable or disable tr069 through the management interface. Disabled by default.
SYSLOG Through Management Interface	Enable or disable syslog through the management interface. Disabled by default.
Layer 2 QoS 802.1Q/VLAN Tag	Assigns the VLAN Tag of the Layer 2 QoS packets.
Layer 2 QoS 802.1p Priority Value	Assigns the priority value of the Layer 2 QoS packets. Valid range is 0 to 7.
IP Address Mode	The IPv4 address obtained on the phone using which method: DHCP or Static IP assignment.

Static IP Settings	
IPv4 Address	Enter the IP address when static IP is used.
Subnet Mask	Enter the Subnet Mask when static IP is used.
Gateway	Enter the Default Gateway when static IP is used.
DNS Server 1	Enter DNS Server 1 when static IP is used.
DNS Server 2	Enter DNS Server 2 when static IP is used.
Network → Open VPN® Settings	
OpenVPN® Enable	Enables/Disables the OpenVPN® feature. Default settings is No.
OpenVPN® Server Address	Configures the address of the OpenVPN® server.
OpenVPN® Port	Defines the port of the OpenVPN® server. Default is 1194.
OpenVPN® Transport	Determines network protocol UDP or TCP used for OpenVPN®. Default is UDP.
OpenVPN® CA	Uploads the OpenVPN® CA.
OpenVPN® Certificate	Uploads the OpenVPN® Certificate.
OpenVPN® Client Key	Uploads the OpenVPN® Client Key.
OpenVPN® Cipher Method	Must be the same cipher method used by the OpenVPN® server
OpenVPN® Username	OpenVPN® authentication username (optional)
OpenVPN® Password	OpenVPN® authentication password (optional)
Additional Options	Additional options are to be appended to the OpenVPN® config file, separated by a semicolon. For example comp-lzo no; auth SHA256 Note: Please use it with caution. Make sure that the options are recognizable by OpenVPN® and do not unnecessarily override the other configurations above.
Network => SNMP Settings	
Enable SNMP	Enables/Disables the SNMP feature. Default settings is No
Version	Version SNMP version, the available options are: <ul style="list-style-type: none"> ● Version 1 ● Version 2 ● Version 3
Port	SNMP port. Default is 161.
Community	Configures the Name of SNMP trap community.
SNMP Trap Version	SNMP Trap Version. Default is Trap Version 2.
SNMP Trap IP	IP address of the SNMP trap receiver.
SNMP Trap Port	Port of the SNMP trap receiver. Default is 162.
SNMP Trap Interval	The interval between each trap sent to the trap receiver. Default is 60.
SNMP Trap Community	Community string associated to the trap. It must match the community string of the trap receiver.
SNMP Username	Username for SNMP.
Security Level	noAuthUser: Users with security level noAuthNoPriv and context name as noAuth. authUser: Users with security level authNoPriv and context name as auth. privUser: Users with security level authPriv and context name as priv. Default is NoAuthUser.
Authentication Protocol	Select the Authentication Protocol: "None" or "MD5" or "SHA". Default is None.
Privacy Protocol	Select the Privacy Protocol: "None" or "DES" or "AES". Default is None.
Authentication Key	Enter the Authentication Key

Privacy Key	Enter the Privacy Key.
SNMP Trap Username	User name for SNMP Trap.
Trap Security Level	noAuthUser: Users with security level noAuthNoPriv and context name as noAuth. authUser: Users with security level authNoPriv and context name as auth. privUser: Users with security level authPriv and context name as priv. Default is NoAuthUser.
Trap Authentication Protocol	Select the Authentication Protocol: "None" or "MD5" or "SHA". Default is None.
Trap Privacy Protocol	Select the Privacy Protocol: "None" or "DES" or "AES". Default is None.
Trap Authentication Key	Enter the Trap Authentication Key.
Trap Privacy Key	Enter the Trap Privacy Key

Network Page Definitions

Maintenance Page Definitions

User Password	
New Password	Set new password for web GUI access as User. This field is case sensitive.
Confirm Password	Enter the new User password again to confirm.
Admin Password	
Current Password	The current admin password is required for setting a new admin password.
New Password	Set new password for web GUI access as Admin. This field is case sensitive
Confirm Password	Enter the new Admin password again to confirm.
Upgrade Firmware	Allows users to upload the firmware file locally by pressing Start, after selecting the correct firmware file from the local storage, the phone will start the firmware upgrade automatically.
Firmware Upgrade and Provisioning	Specifies how firmware upgrading and provisioning request to be sent: Always Check for New Firmware, Check New Firmware only when F/W pre/suffix changes, Always Skip the Firmware Check. The default setting is "Always Check for New Firmware".
Always Authenticate Before Challenge	Only applies to HTTP/HTTPS. If enabled, the phone will send credentials before being challenged by the server. The default setting is "No".
Disable Firmware Upgrade Confirmation	Disables the Firmware Upgrade confirmation popup. Set to "No" by Default.
Validate Hostname in Certificate	To validate the hostname in the SSL certificate
Allow DHCP Option 43 and Option 66 Override Server	The default setting is "Yes". DHCP option 66 originally was only designed for TFTP servers. Later on, it was extended to support an HTTP URL. WP phones support both TFTP and HTTP servers via option 66. Users can also use the DHCP option 43 vendor-specific option to do this. DHCP option 43 approach has priorities. The phone is allowed to fall back to the original server path configured in case the server from option 66 fails.
Additional Override DHCP Option	When enabled, users could select Option 150 or Option 160 to override the firmware server instead of using the configured firmware server path or the server from option 43 and option 66 in the local network. Please note this option will be effective only when option "Allow DHCP Option 43 and Option 66 to Override Server" is enabled. The default setting is "None".
Allow DHCP Option 120 to override SIP Server	Enables DHCP Option 120 from local server to override the SIP Server on the phone. The default setting is "No".
3CX Auto Provision	The phone will multicast SUBSCRIBE for provision if this feature is enabled. The default setting is "Yes".
Automatic Upgrade	Enables automatic upgrade and provisioning, the options can be : <ul style="list-style-type: none"> ● Yes, check for upgrade every 10080 minute(s) ● Yes, check for upgrade every day

	<ul style="list-style-type: none"> • Yes, check for upgrade every week • No Set to "No" by Default.
Randomized Automatic Upgrade	Randomized Automatic Upgrade within the range of hours of the day or postpone the upgrade every X minute(s) by random 1 to X minute(s).
Hour of the Day (0-23)	Defines the hour of the day to check the HTTP/TFTP/FTP server for firmware upgrades or configuration files changes. The default value is 1.
Day of the Week (0-6)	Defines the day of the week to check HTTP/TFTP/FTP server for firmware upgrades or configuration files changes. The default value is 1.
Disable SIP NOTIFY Authentication	The device will not challenge NOTIFY with 401 when set to "Yes". The default setting is "No".
Config	
Config Upgrade Via	Allows users to choose the config upgrade method: TFTP, FTP, FTPS, HTTP or HTTPS. The default setting is "HTTPS".
Config Server Path	Defines the server path for provisioning. Note: you can define the server path prepended with the protocol used, For example when using HTTPS as the upgrade method, you can set the config server path to: https://server_address
Config Server Username	The username for the config server.
Config Server Password	The password for the config server.
Config File Prefix	Enables your ITSP to lock configuration updates. If configured, only the configuration file with the matching encrypted prefix will be downloaded and flashed into the phone.
Config File Postfix	Enables your ITSP to lock configuration updates. If configured, only the configuration file with the matching encrypted postfix will be downloaded and flashed into the phone.
XML Config File Password	The password for encrypting XML configuration file using OpenSSL. This is required for the phone to decrypt the encrypted XML configuration file.
Enable Handset Config Upgrade	Enable handset config upgrade for handset related settings. Disabled by Default.
Handset Config File Prefix	If configured, only the handset configuration file with the matching encrypted prefix will be downloaded and flashed into the device. If the file is located in a subdirectory on the provisioning server, the directory should be included here; for example "handset/ipei_".
Handset Config File Postfix	If configured, only the handset configuration file with the matching encrypted postfix will be downloaded and flashed into the device.
Authenticate Conf File	Sets the phone system to authenticate configuration file before applying it. When set to "Yes", the configuration file must include value P1 with phone system's administration password. If it is missed or does not match the password, the phone system will not apply it. Default setting is "No".
Download Device Configuration	Click to download the phone's configuration file in .txt format. Note: Configuration backup file does not include passwords or CA/Custom certificate
Download Device Configuration (XML)	Click to download the device configuration file in .xml format.
Download and Process All Available Config Files	By default, the device will provision the first available config in the order of cfgMAC, cfgMAC.xml, cfgMODEL.xml, and cfg.xml (corresponding to device-specific, model-specific, and global configs). If this option is enabled, the phone will inverse the downloading process to cfg.xml > cfgMAC.bin > cfgMAC.xml. The following files will override the files that have already been loaded and processed.
Download User configuration	This allows users to download part of the configuration that does not include any personal settings like Username and Passwords. Also, it will include all the changes manually made by user from web UI, or config file uploaded from "Upload Device Configuration", but not include the changes from the server provision via TFTP/FTP/FTPS/HTTP/HTTPS.
Upload Device Configuration	Uploads configuration file to phone.
Export backup Package	Export backup package which contains device configuration along with personal data.

Restore from Backup package	Click to upload backup package and restore.
Firmware	
Firmware Upgrade Via	Allows users to choose the firmware upgrade method: TFTP, FTP, FTPS, HTTP or HTTPS. The default setting is "HTTPS".
Firmware Server Path	Defines the server path for the firmware server. Note: you can define the server path prepended with the protocol used, For example when using HTTPS as the upgrade method, you can set the firmware server path to: https://server_address
Firmware Server Username	The username for the firmware server.
Firmware Server Password	The password for the firmware server.
Firmware File Prefix	Enables your ITSP to lock firmware updates. If configured, only the firmware with the matching encrypted prefix will be downloaded and flashed into the phone.
Firmware File Postfix	Enables your ITSP to lock firmware updates. If configured, only the firmware with the matching encrypted postfix will be downloaded and flashed into the phone.
HS Firmware	
Handset firmware	<ul style="list-style-type: none"> ● Upload: Uploads handset firmware. Reboot the device after uploading to apply and use the new firmware. ● Delete: Deletes previously uploaded handset firmware.
Automatic Upgrade	<ul style="list-style-type: none"> ● Disable: disables automatic firmware upgrade. ● Enable: enables automatic upgrade when the handset detects a new firmware. ● Enable, But Downgrade not Allowed: enables automatic firmware upgrade but prohibits firmware downgrade. <p>The default setting is "Enable".</p>
Syslog	
Syslog Protocol	If set to SSL/TLS, the Syslog messages will be sent through secured TLS protocol to Syslog server. The default setting is UDP. Note: The CA certificate is required to connect with the TLS server.
Syslog Server	The URL or IP address of the syslog server for the phone to send syslog to. Note: <ul style="list-style-type: none"> ● By adding a port number to the Syslog server field (i.e. 172.18.1.1:1000), the phone will send Syslog to the corresponding port of that IP. ● Administrators can save the syslog settings parameters across a factory reset, by assigning value 1 to the P-value P82307 from the device configuration file, this is because this configuration parameter is not available on the webUI.
Syslog Level	Selects the level of logging for syslog. The default setting is "None". There are 4 levels: DEBUG, INFO, WARNING and ERROR. Syslog messages are sent based on the following events: Product model/version on boot up (INFO level). NAT related info (INFO level). sent or received SIP message (DEBUG level). SIP message summary (INFO level). inbound and outbound calls (INFO level). registration status change (INFO level). negotiated codec (INFO level). Ethernet link up (INFO level). SLIC chip exception (WARNING and ERROR levels). Memory exception (ERROR level).
Syslog Keyword Filtering	Syslog will be filtered based on keywords provided. If you enter multiple keywords, it should be separated by ','. Please note that no spaces are allowed.
Send SIP Log	Configures whether the SIP log will be included in the syslog messages. The default setting is "No". Note: By setting Send SIP Log to Yes, the phone will still send SIP log from syslog even when Syslog Level is set to NONE.
Syslog Capture	
Status	Shows the status of the capture, whether it is "stopped" or capturing, you have the possibility to start the capture, stop the capture, and download it.
Capture Mode	Sets the capture mode. Either set to Timed mode or continuous. <ul style="list-style-type: none"> ● Timed Mode: When a new capture is running, the previous files are deleted. Capture Timer is optional, if Internal Storage is selected, the maximum Capture Timer limit is 30 minutes. ● Continuous Mode: This mode allows device to capture logs continuously during the days set under Continuous Capture Days option.

Capture Timer	If Capture Mode is set to "Timed" this field will appear to specify how long to capture syslog in minutes. 0 is unlimited. Internal capture has a 30-minute maximum limit.
Log File Rotation	Rotation is always enabled when capturing internally. Log File Rotation will maintain a fixed maximum limit of the file size based on the Max Log File Size and Max Log Files configured. Old logs will be deleted when rotated.
Max Log File Size	The maximum log file size used when rotation is enabled
Max Log Files	The number of log files used when rotation is enabled
TR-069	
Enable TR-069	Sets the phone to enable the "CPE WAN Management Protocol" (TR-069). The default setting is "Yes". Note: Once you enable or disable TR-069 and click "save," a confirmation pop-up will appear, asking you to confirm your desire to reboot the device.
ACS URL	Specifies URL of TR-069 ACS (e.g., http://acs.mycompany.com), or IP address. The default setting is https://acs.dgms.cloud
TR-069 Username	Specifies the username to authenticate to ACS.
TR-069 Password	Specifies the password to authenticate to ACS.
Periodic Inform Enable	When enabled, periodic information packets to the ACS server will be sent. The default setting is "Yes"
Periodic Inform Interval	Configures periodic inform intervals to send the inform packets to TR-069 Auto Configuration Server. The default setting is 86400
Connection Request Username	Specifies the username for the ACS to connect to the phone.
Connection Request Password	Specifies the password for the ACS to connect to the phone.
Connection Request Port	The port for the ACS to connect to the phone.
CPE SSL Certificate	Uploads Cert File for the phone to connect to the ACS via SSL.
CPE SSL Private Key	Uploads Cert Key for the phone to connect to the ACS via SSL.
Randomized TR069 Startup	When enabled, TR069 will send out first INFORM message to server on randomized timing between 1 to 3600 seconds after phone boots up.
Security Settings	
Enable/Disable Weak Ciphers	Allows users to enable Weak TLS Ciphers Suite or disable weak ciphers DES/3DES and RC4, Symmetric Encryption SEED, Symmetric Authentication MD5, Protocol Version SSLv2/SSLv3 or Disable All of The Above Weak TLS Ciphers Suites. This feature could force the TLS version/Cipher suites for HTTPS provisioning and the TLS version for sip transport (TLS/TCP) and HTTPS web access.
Validate Server Certificates	After enabling this feature, the phone will validate the server's certificate. If the server that our phone tries to register on is not on our list, it will not allow the server to access the phone.
SIP TLS Certificate	SSL Certificate used for SIP Transport in TLS/TCP.
SIP TLS Private Key	SSL Private key used for SIP Transport in TLS/TCP.
SIP TLS Private Key Password	SSL Private key password used for SIP Transport in TLS/TCP.
Custom Certificate	The uploaded custom certificate will be used for SSL/TLS communication instead of the WP phone default certificate.
Web Access Mode	Sets the protocol for web interface. The default setting is "HTTP".
Enable User Web Access	Administrator can disable or enable user web access. The default value is Disabled.

HTTP Web Port	Configures the HTTP port under the HTTP web access mode.
HTTPS Web Port	Configures the HTTPS port under the HTTPS web access mode. Default setting is "443".
Disable SSH	Disables SSH access. The default setting is "No".
SSH Public Key	This option allows you to use authentication keys for SSH access. The public key should be loaded to the phone's web UI while the private key should be used on the SSH tool side. Note: This will allow upcoming SSH access without a password.
Web Session Timeout	Configures timer to logout web session during idle. Default is 10 min. Range is 2-60 min.
Web Access Attempt Limit	Configures attempt limit before logout. Default is 5. Range is 1-10.
Minimum TLS Version	Allows users to choose the minimum TLS version for HTTPS provisioning. Note: Minimum TLS version should be less or equal to the Maximum TLS version. The default setting is TLS 1.1
Maximum TLS Version	Allows users to choose the maximum TLS version for HTTPS provisioning. Set to unlimited.
Trusted CA Certificates	
Trusted CA Certificates	Allows to upload and delete up to 6 CA Certificates files to the phone. Note: Users can either upload the file directly from the web or they can choose to provision it from their cfg.xml file.
Load CA Certificates	Users are able to specify which certificate they are going to use: All Certificates: (Default) Both built-in and uploaded Certificates. Default Certificates: Built-in Certificates. Custom Certificates: Uploaded Certificates;
Packet Capture	
With RTP Packets	Choose whether the packet capture file contains RTP or not. Set to no by default.
With Secret Key Information	Allows users to make packet capture including the secret key to decrypt the captured TLS packets. Default value is No.
Factory Reset	
Force Reboot	Allows for manual restarts, resolving issues by power cycling the system, enhancing overall performance and stability.
Configure Web UI Button	
Reset Type	Specifies the type of reset to perform via the web UI button below, the options are: <ul style="list-style-type: none"> • Full Factory Reset. • NVRAM Settings only. • DECT Settings only. By default, it is set to Full Factory Reset.
Perform Selected Reset	Executes the type of reset chosen.
Configure Hardware Button	
Reset Type	Specifies the type of reset to perform via the web UI button below, the options are: <ul style="list-style-type: none"> • Full Factory Reset. • NVRAM Settings only. • DECT Settings only. By default, it is set to Full Factory Reset.
Automatic Reboot	
No	This option disables the automatic reboot of the unit.
Yes, reboot daily	When this option is selected, the unit is rebooted daily at a specific Reboot Time defined.
Yes, reboot every week on	When this option is selected, the unit is rebooted on a specific day of the week (Monday to Sunday), at a specific reboot time.
Yes, reboot every month on day	When this option is selected, the unit is rebooted once a month on a specified date (1st to 31st) and time .
Reboot Time	Defines the Reboot time in HH:MM format

Tools	
Provision	Makes the phone trigger an instant provisioning.
Ping	Makes the phone ping an URL to check if it has access to it.
Traceroute	Checks the route packets take to the specified URL.
Outbound Notification	
Action URL HSX <i>(X represents the handset number (1-10))</i>	
Setup Completed	Configures the Action URL to send when this handset finishes setup process.
Registered	Configures the Action URL to send when this handset successfully registers a SIP account.
Unregistered	Configures the Action URL to send when this handset unregisters a SIP account.
Off Hook	Configures the Action URL to send when this handset is in off-hook state.
On Hook	Configures the Action URL to send when this handset is in on-hook state.
Incoming Call	Configures the Action URL to send when this handset receives an incoming call.
Outgoing Call	Configures the Action URL to send when this handset places a call.
Missed Call	Configures the Action URL to send when this handset has a missed call.
Established Call	Configures the Action URL to send when this handset establishes a call.
Terminated Call	Configures the Action URL to send when this handset terminates a call.
Open DND	Configures the Action URL to send when this handset enables DND.
Close DND	Configures the Action URL to send when this handset disables DND.
Open Forward	Configures the Action URL to send when this handset enables call forward function.
Close Forward	Configures the Action URL to send when this handset disables call forward function.
Blind Transfer	Configures the Action URL to send when this handset performs blind transfer.
Attended Transfer	Configures the Action URL to send when this handset performs attended transfer.
Hold Call	Configures the Action URL to send when this handset places a call on hold.
UnHold Call	Configures the Action URL to send when this handset resumes the call on hold.

Maintenance Page Definitions

Phonebook Page Definitions

Phonebook General Settings	
Default Search Mode	<p>Configures the default phonebook search mode. The supported modes are:</p> <ul style="list-style-type: none"> ● Quick Match: users can search with more flexibility as the returned results contain any possible matches for the search term. ● Exact Match: users can search more precisely as the returned results only include exact matches of the search term. <p>The default search mode is Quick Match.</p>
Sort Phonebook by	<p>Configures to sort phonebook either based on the first name or last name.</p> <ul style="list-style-type: none"> ● Last name: the contact's last name will be displayed first, and the phone book will be sorted by last names. ● First name: the contact's first name will be displayed first, and the phone book will be sorted by first names. <p>By default, phonebook is sorted by Last Name.</p>
Global Phonebook XML Settings	
Global Phonebook Type	<p>Selects type of global phonebook to use.</p> <ul style="list-style-type: none"> ● If set to XML, DP755 will use the configuration in the Global Phonebook XML Settings page.

	<ul style="list-style-type: none"> • If set to LDAP, DP755 will use the configuration in the Global Phonebook LDAP Settings page. • If set to XSI, DP755 will use the configuration in the Global Phonebook XSI Settings page.
Automatic XML Phonebook Download	
Enable Automatic XML Phonebook Download	Sends periodic requests to download XML Phonebook via HTTP, HTTPS, or TFTP.
HTTP/HTTPS User Name	Enters user name to authenticate with HTTP/HTTPS server.
HTTP/HTTPS Password	Enters password to authenticate with HTTP/HTTPS server.
Phonebook XML Server Path	Indicates server path to download XML phonebook file. This field could be IP address or URL, with up to 256 characters.
Phonebook Download Interval	Sets interval to send XML phonebook download requests (in minutes). If set to 0, automatic download is disabled. Valid range is 5 to 720. Default is 5 minutes.
Manual XML Phonebook Management	
Import XML Phonebook	Upload: Uploads manually the global XML phonebook file to the base station. Delete: Clears global XML phonebook file in the base station.
Export XML Phonebook	Downloads global XML phonebook from the base station in .xml format.
Global Phonebook LDAP Settings	
Global Phonebook Type	Selects type of global phonebook to use. If set to XML, DP755 will use the configuration in Global Phonebook XML Settings page. If set to LDAP, DP755 will use configuration in Global Phonebook LDAP Settings page.
LDAP Phonebook Settings	
LDAP protocol	Chooses LDAP or LDAPS (LDAP over TLS) protocol. Default is LDAP.
Server Address	Configures IP address or domain name of the LDAP server.
Port	Determines LDAP server port. Default is 389.
Base	Indicates the location in the directory where the search is requested to begin. Example: dc=grandstream, dc=com ou=Boston, dc=grandstream, dc=com
User Name	Binds "Username" for querying LDAP servers. Some LDAP servers allow anonymous binds in which case the setting can be left blank.
Password	Binds "Password" for querying LDAP servers. The field can be left blank if the LDAP server allows anonymous binds.
LDAP Filter	LDAP filter to limit which contacts are fetched from the server. LDAP statement to limit which contacts are fetched from the server. Statement must be in parenthesis.
LDAP Version	Selects LDAP protocol version to send bind requests. Default is Version 3.
First Name Attribute	Defines first name attributes of each record to be returned in the LDAP search result. This field allows users to configure multiple space-separated name attributes. Example: gn cn sn description
Last Name Attribute	Defines the last name attributes of each record to be returned in the LDAP search result. This field allows users to configure multiple space-separated name attributes. Example: gn cn sn description
Work Number Attribute	Specifies which LDAP attribute represent the contact's work number. Must be in number attributes on LDAP server.
Home Number Attribute	Specifies which LDAP attribute represent the contact's home number. Must be in number attributes on LDAP server.
Mobile Number Attribute	Specifies which LDAP attribute represent the contact's mobile number. Must be in number attributes on LDAP server.
Max. Hits	Specifies a maximum number of results to be returned by the LDAP server. If set to 0, the server will return all search results. The valid range is 1 to 3000. The default is 500.
Search Timeout	Sets interval (in seconds) for the server to process the request and return search results to the client. Default is 30 seconds.

LDAP Contact Download Interval	Configures the download interval (in minutes). The base station will cache the results for the handsets to access. Valid range is 0 to 1440. If set to 0, will instead query LDAP whenever a handset accesses the contact list menu. Default value is 5 minutes.
Global Phonebook Broadsoft XSI Settings	
Broadsoft XSI Notes:	
<ul style="list-style-type: none"> • The broadsoft XSI settings can be applied independently on all the 20 accounts supported by the DP755 base station. • Broadsoft call logs can be deleted from the connected handsets. • Broadsoft call logs can be sorted by name, as well as by date. 	
XSI	
Account	Lists down the accounts that can be used for XSI server connection
Server	Configure the BroadWorks Xsi server URI. If the server uses HTTPS, please add the header "HTTPS" ahead of the Server URI. For instance, "https://SERVER_URI".
Port	Configure the BroadWorks Xsi server port. The default port is 80. If the server uses HTTPS, please configure 443.
XSI Actions Path	configure the deployment path for Broadsoft XSI Actions. If it is empty, the path "com.broadsoft.xsi-actions" will be used.
Broadsoft Contact Download Interval	Configures the broadsoft phonebook download interval (in minutes). If set to 0, automatic download will be disabled. Valid range is 5 to 4320. Default is 4320 Minutes.
Login Credentials	
Account	Lists down the accounts with their respective Authentication type.
XSI Authentication Type	This feature allows users to choose the type of authentication that will be used to access the XSI information from the handset, there are three types of authentications: <ul style="list-style-type: none"> • Through Login credentials: Uses the log in Username and password for authentication • Through SIP credentials: Uses the SIP User ID, SIP Auth ID, and SIP Password for authentication • Match SIP Account: Uses the credentials used in the SIP account of the DP755.
Login Username	Configure the Username for the BroadWorks XSI server.
Login Password	Configure the password for the BroadWorks XSI server.
SIP User ID	Configure SIP User ID for the BroadWorks XSI server.
SIP Auth ID	Configure SIP Authentication ID for the BroadWorks XSI server.
SIP Password	Configure SIP Password for the BroadWorks XSI server.
XSI Account Assignment	This setting can be applied individually for the 10 handsets supported by DP755.
Handset	Displays the handset on which the XSI setting will be applied
XSI Account	Sets the SIP account that will be used on the specific handset
Call Log Type	Sets which call logs will be displayed on the handset, there are two options: <ul style="list-style-type: none"> • Use XSI Call logs • Use Base Station Call Logs
Network Directories	Enable/Disable and choose the name of the following types: Group Directory; Enterprise Directory; Group Common; Enterprise Common; Personal Directory.
Service Settings	
Sort Phonebook by	Configures to sort phonebook either based on the first name or last name. <ul style="list-style-type: none"> • Last name: the contact's last name will be displayed first, and the phone book will be sorted by last names. • First name: the contact's first name will be displayed first, and the phone book will be sorted by first names. By default, phonebook is sorted by Last Name.

Broadsoft Contacts Download Limitation	Configures the max number of contacts that can be downloaded for each BroadSoft XSI server directory. If set to 0 , the server's default contact limit will be used. The valid range is from 0 to 2000 , and the default setting is 100 .
Private Phonebook Settings	
Upload XML Phonebook 1-10	
Phonebook Name	Defines private phonebook name.
Import XML Phonebook	Upload: Uploads manually a private XML phonebook file to the base station. Delete: Clears private XML phonebook file in the base station
Export XML Phonebook	Downloads private XML phonebook from the base station in .xml format.

Phonebook Page Definitions

Change Base Station Admin PIN code

For security reasons, advanced settings in the DP755 base station cannot be accessed from DP720/DP722/DP725/DP730/DP735 Handsets except if an Admin PIN code is provided. By default, the Admin PIN code is 0000.

We strongly recommend changing your Admin PIN code following below steps:

1. Access the Web GUI of your DP755 using the admin's username and password.
2. Press **Login** to access your settings.
3. Go to **the DECT → General Settings** tab.
4. Enter your new **Admin PIN Code** (only digits accepted) in the appropriate field.
5. Press **Save and Apply** to save your settings.

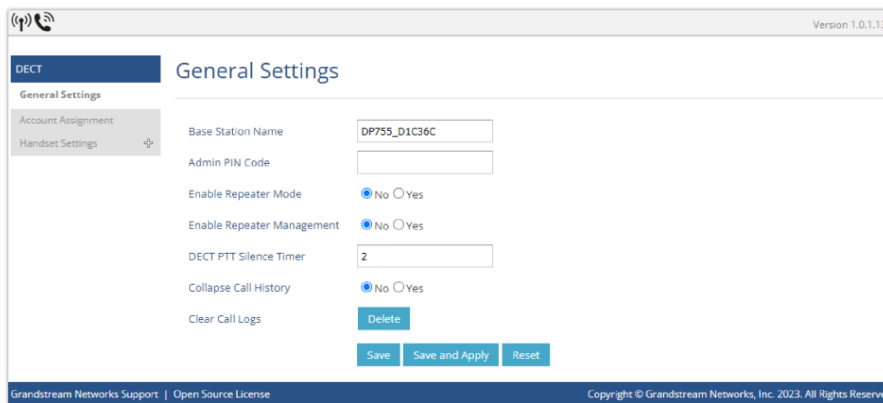

Register DP Handsets to DP755 Base Station

Before attempting to register a DP720/DP722/DP725/DP730/DP735 handset, users need to open the base station subscription using one of the following methods:

Open Subscription from DP755

To initiate the subscription process on the DP755 Base Station, press and hold the Radio/Page  button for 4 seconds until the Radio icon starts blinking. Alternatively, users can reboot the base station, as the subscription window remains open for 2 minutes each time the device restarts.

Open Subscription from the Web UI

Users can open the subscription by accessing the web UI and clicking the "Open Subscription"  icon. Once the action is completed successfully, a prompt will appear confirming that the subscription window has been opened, and the icon will change to green.

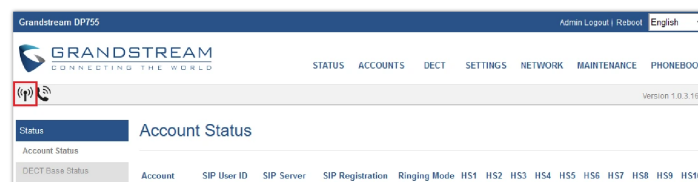

Open Subscription Icon

Open Subscription through GDMS

To open the DP755 subscription using this method, follow these steps:

1. Log in to GDMS and navigate to the **VoIP Device** section under the organization where the base station device is registered.
2. Locate the base station device, then click the three dots under the **Options** menu.
3. Select **Open Subscription** from the dropdown.

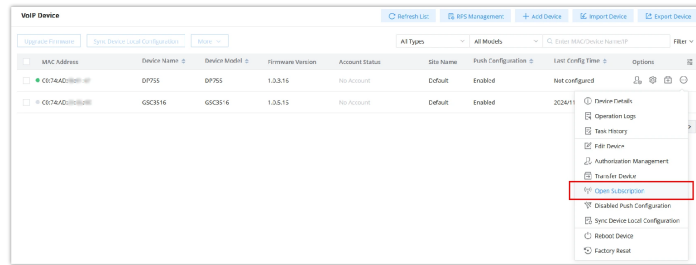

GDMS VoIP Device Page

4. Once the subscription is successfully opened, a confirmation prompt will appear, notifying users that the subscription is active for 2 minutes.

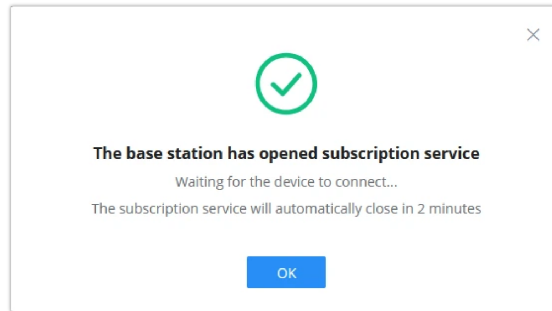

Open Subscription Prompt

Registering the DP720/DP722/DP725/DP730/DP735 Handsets

1. Open the subscription using one of the methods mentioned above.
2. On DP720/DP722/DP725/DP730/DP735, press "Subscribe" softkey is available on the main screen or access **Menu** → **Registration** → **Register** while the DP755 Radio icon is blinking.
Note: "Subscribe" softkey appears only if DP720/DP722/DP725/DP730/DP735 is not registered to any DP755 base station.
3. Select **BaseX** (X=1-4) corresponding to the desired base station DP755, then press **Subscribe**.
4. The DP720/DP722/DP725/DP730/DP735 will search for nearby base stations and will display the RFPI code and Base station name of the discovered DP755.
5. Press **Subscribe** to pair with the displayed DP755.
6. The DP720/DP722/DP725/DP730/DP735 will display **Easy Pairing** on the LCD and play an audible buzz when successful. Then it will return to the home screen, displaying the Handsets name and number assigned by the registered base station.

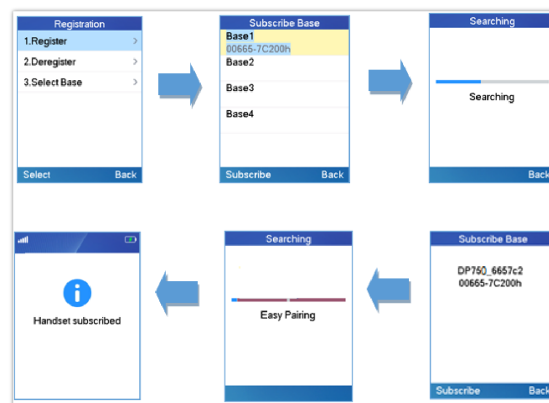

Registration Process

Note

DP755 supports 10 handsets registration and 16 simultaneous calls on 8 handsets.

Using DP Handsets with Multiple DP755 Base Stations

DP720/DP722/DP725/DP730/DP735 is able to be registered to up four different DP755 base stations.

Registering DP720/DP722/DP725/DP730/DP735 to an additional DP755 base station

Considering DP720/DP722/DP725/DP730/DP735 is previously registered to an initial base station, please follow below steps to register a Handsets to an additional base station:

1. Press **Menu** (left softkey or the selection key) to bring up operation menu.
2. Use arrow keys to reach **Registration**.

3. Select **Register**.
4. Navigate to an unsubscribed base using arrow keys, and click on **Subscribe**.
5. Make sure that the subscription is opened on the new base station.

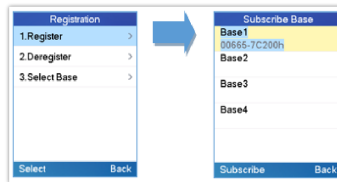

Multiple Base Stations Registration

Switching Between Different Base Stations

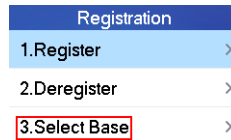

1. Press "Menu" (left softkey or the selection key) to bring up the operation menu.
2. Use arrow keys to reach Registration.
3. Navigate to Select Base using the arrow keys.
4. Select the desired base station and press **Select**.



Switching Between Base Stations

Unregister the DP720/DP722/DP725/DP730/DP735

Using DP720/DP722/DP725/DP730/DP735 Handsets:

1. On DP720/DP722/DP725/DP730/DP735, press "Menu" (left softkey  or the selection key ) to bring up operation menu.
2. Press arrow keys to move the cursor to **Registration**, then press "Select" (left softkey).
3. Navigate to **Deregister**.
4. Select the Handsets to be unregistered and press "Deregister" (left softkey).
5. Enter the system PIN code (default: 0000).
6. Press "Done" (left softkey) to confirm or "Back" (right softkey) to cancel.

Using DP755 Base Station UI:

1. Access DP755 Web Interface.
2. Go to **Status** → **DECT Base Status**.
3. Locate the Handsets to unregister and press the "**Unsubscribe**" button.

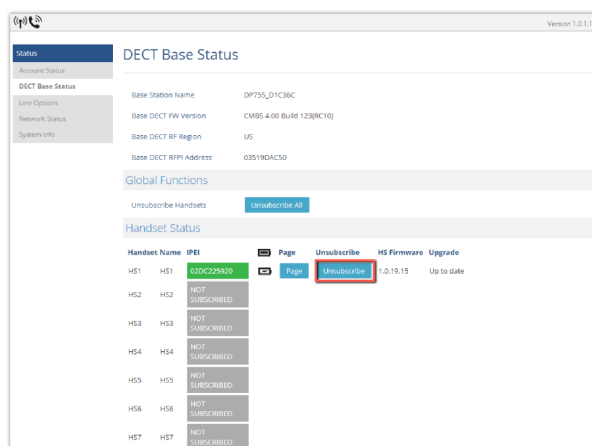

Unregister DP720/DP722/DP725/DP730/DP735 from DP755 web UI

Locating DP Handsets from DP755 Base station

In some situations, you may have a DP720/DP722/DP725/DP730/DP735 Handsets incorrectly positioned and you don't know its current location. You can locate a DP720/DP722/DP725/DP730/DP735 Handsets from his registered DP755 base station using the below steps:

Locate via DP755 Web UI

1. Access the Web GUI of your DP755 using the admin's username and password.
2. Press Login to access your settings and navigate to the **Status → DECT Base Status** tab.
3. Choose which Handsets to locate and press the corresponding Page button.
4. A paging call will be received on the selected DP720/DP722/DP725/DP730/DP735 Handsets.
Note: If you press Page All icon, all registered DP720/DP722/DP725/DP730/DP735 Handsets will be receiving the paging call.
5. Once located, you can press End Softkey to end the paging call.

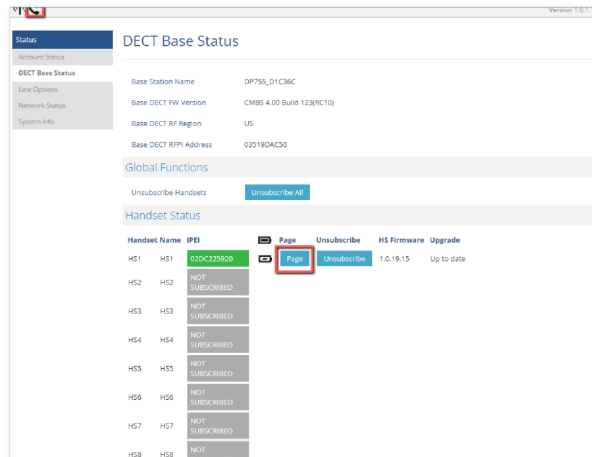

Locate Handsets via Web UI

Locate via DP755 Base station

1. On the DP755 Base station front side, press Radio/Page button.
2. All registered Handsets will receive Paging call.
3. Once located, you can end the paging calling by pressing any key on the Handsets or by pressing again **Radio/Page**



button.

Register a SIP Account

DP755 supports up to 20 SIP accounts, 10 Handsets. Each Handset can be configured with up to 20 accounts. Please be aware that line settings will be affected by DID settings (hunting group settings) in "**DECT → SIP Account Settings**".

Register Account via Web User Interface

1. Access the Web GUI of your DP755 using the admin's username and password.
2. Press **Login** to access your settings and navigate to **the** Accounts tab and select an account to use.
Note: DP755 supports up to 20 accounts. An account is a set of settings including general settings, network settings, SIP settings, audio settings, call settings, and ring tones, etc.
3. In General, Settings, set the following:
 - Account Active to Yes.
 - SIP Server field with your SIP server IP address or FQDN.
 - Failover SIP Server with your Failover SIP Server IP address or FQDN. Leave empty if not available.
 - Prefer Primary SIP Server to No or Yes depending on your configuration. Set to No if no Failover SIP Server is defined. If "Yes", account will register to Primary SIP Server when failover registration expires.
 - Outbound Proxy with your Outbound Proxy IP Address or FQDN. Leave empty if not available.
 - SIP User ID User account information, provided by VoIP service provider (ITSP). Usually in the form of a digit similar to a phone number or actually a phone number.
 - **Authenticate ID:** SIP service subscriber's Authenticate ID used for authentication. Can be identical to or different from SIP User ID.
 - **Authenticate Password:** SIP service subscriber's account password to register to SIP server of ITSP. For security reasons, the password will field will be shown as empty.
 - **Name:** Any name to identify this specific user.
4. Press **Save and Apply** to save your configuration.

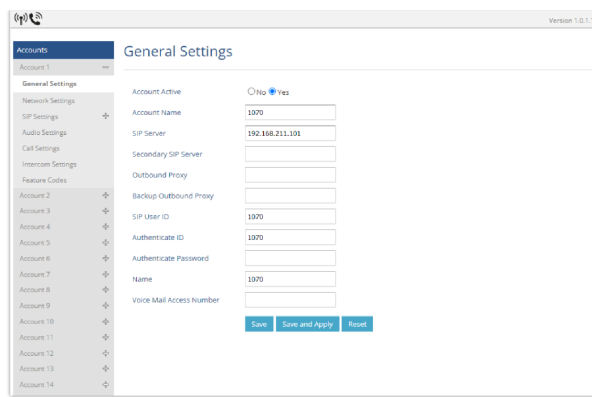

SIP Settings

5. Go to **DECT** → **ACCOUNT ASSIGNMENT**

6. Select the corresponding Ringing mode of the assigned account: (which handset will ring when extension 1070 is called)
 - o **Parallel Mode:** selecting parallel will mean all selected handsets will be ringing at the same time.
 - o **Circular Mode:** all selected phones ring in sequence, beginning with the phone that follows the one that rang last.
 - o **HS x:** the selected handset will ring.

7. Press **Save and Apply** to save your configuration.

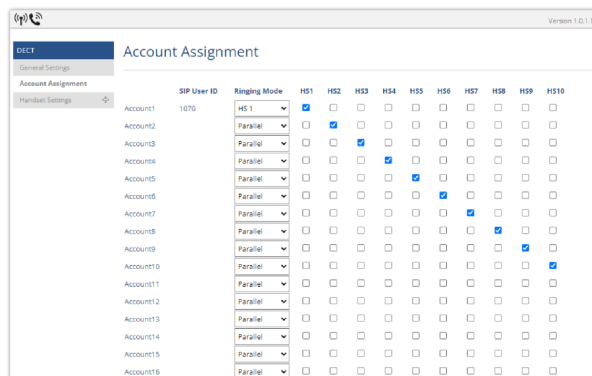

Account Status

After applying your configuration, your phone will register to your SIP Server.

You can verify if your DECT phone has registered with your SIP server from your DP755 web interface under **Status** → **Account Status** (a green background with Yes under the SIP Registration column for the corresponding account indicates the account(s) has been successfully registered).

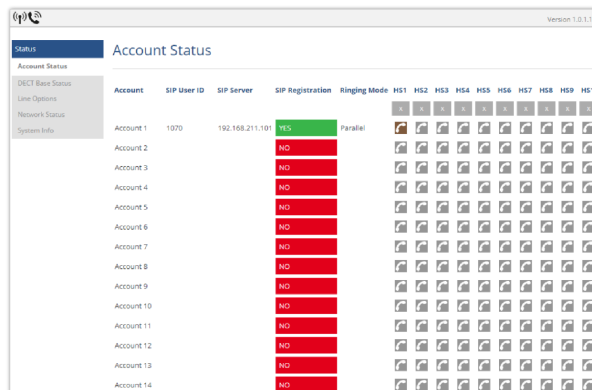

Account registered

Multiple Lines and Hunting Groups

The DP755 Base Station has the ability to assign 20 lines to each registered DP720/DP722/DP725/DP730/DP735 Handsets (Up to 10 Handsets) to receive/make calls.

When a Handset has many lines configured, users can select specific lines for outgoing calls using the **Outgoing Default Line** feature.

For incoming calls, users can choose either to redirect them to a specific Handset or to many using the Hunting Group feature so as to have the same phone number and incoming calls will be distributed in a Circular or Parallel manner among the Handsets active in that Hunting Group. The number of hunting groups is limited by the number of SIP accounts registered to the base station (up to 20 accounts).

The hunting group feature is mainly used in office, warehouse, and call center environments to distribute incoming calls in the best way depending on the type of hunting group.

In order to configure hunting groups for DP720/DP722/DP725/DP730/DP735 Handsets registered to the Base, users need first to register SIP accounts on DP755 Base Station **Account Settings** and then assign accounts accordingly as lines for DP720/DP722/DP725/DP730/DP735 **Account Assignment**.

Account Assignment

This section will describe how to assign an account for each DP720/DP722/DP725/DP730/DP735 Handsets for making calls.

1. Access the Web GUI of your DP755 using the admin's username and password.
2. Press **Login** to access your settings.
3. Go to **DECT** → **Account Assignment** and assign to Handsets the SIP accounts already configured. Each **Handset** can be configured to use up to 20 SIP accounts.

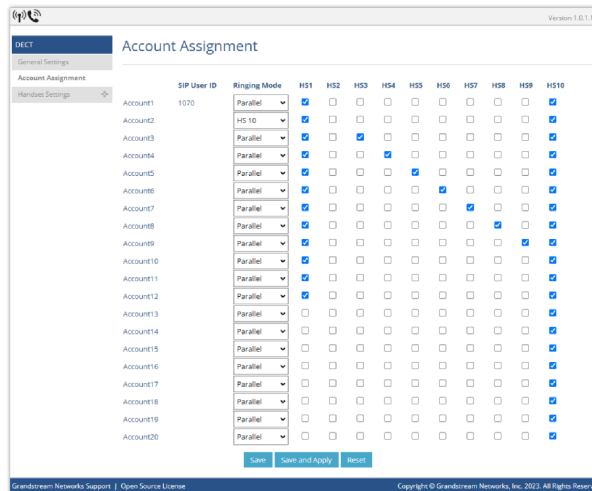

Handsets Line Settings

After applying your configuration, **the** Account Status page will display the status of Handsets along with the accounts status. Each column shows one HS; each row shows if the account is assigned to an HS.

For example: If account 1 is assigned to the HS1, and HS10, the column of both handsets will be marked in brown color as shown in the screenshot below

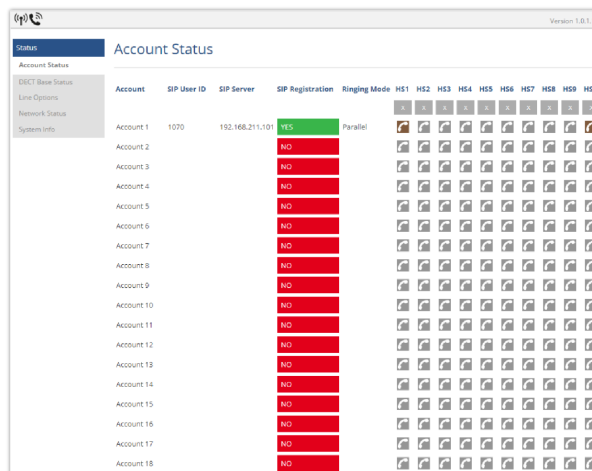

Account Status

Outgoing Default Line

When a Handset is configured with more than one line, users can change the default outgoing line on DP720/DP722/DP725/DP730/DP735 Handsets using the keypad **Menu** → **Preferences** → **Outgoing Default Line**.



Outgoing Default Line

Hunting Groups

DP755 supports parallel and circular hunting groups as described below:
In the examples below, we consider that all Handsets are in the same hunting group.

- **Circular:** The base station will note which Handsets answered the last call, and forward the call to the next available Handsets in round-robin fashion.

In the example below, the 1st incoming call was sent to HS1 since all Handsets were available; 2nd incoming call will be sent to HS2 since previous call was answered by HS1 and HS2 is the next available Handsets in the list; 3rd will be sent to HS4 since HS2 was the last one answering the call and HS3 is busy making an outgoing call (if HS3 was available, the call will be sent to HS3).

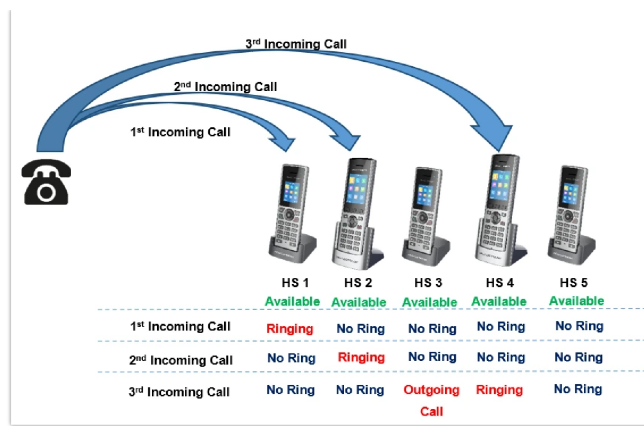

- o **Parallel:** In this mode, all phones ring concurrently. If one phone answers, the remaining available phones can make new outgoing calls.



This section will describe how to configure hunting groups for incoming calls:

The below steps are considering that SIP accounts were previously registered.

1. Access the Web GUI of your DP755 using the admin's username and password.
2. Press **Login** to access your settings.
3. Go to **DECT → Account Assignment**.
4. Set **Ringing Mode** depending on your needs to configure your hunting groups.
5. Press **Save and Apply** to save your settings.

Example:

In the example below Account 1 (1070) is assigned to HS1, HS2, HS3, and HS4, and the hunting group (Ringing Mode) is set to Parallel, so incoming calls to that account will make all handsets ring at the same time.

SIP User ID	Ringing Mode	HS1	HS2	HS3	HS4	HS5	HS6	HS7	HS8	HS9	HS10
Account11	Parallel	<input checked="" type="checkbox"/>	<input checked="" type="checkbox"/>	<input checked="" type="checkbox"/>	<input checked="" type="checkbox"/>	<input type="checkbox"/>	<input type="checkbox"/>	<input type="checkbox"/>	<input type="checkbox"/>	<input type="checkbox"/>	<input type="checkbox"/>
Account12	HS 10	<input type="checkbox"/>	<input type="checkbox"/>	<input type="checkbox"/>	<input type="checkbox"/>	<input type="checkbox"/>	<input type="checkbox"/>	<input type="checkbox"/>	<input type="checkbox"/>	<input type="checkbox"/>	<input checked="" type="checkbox"/>
Account13	HS 10	<input type="checkbox"/>	<input type="checkbox"/>	<input type="checkbox"/>	<input type="checkbox"/>	<input type="checkbox"/>	<input type="checkbox"/>	<input type="checkbox"/>	<input type="checkbox"/>	<input type="checkbox"/>	<input checked="" type="checkbox"/>
Account14	HS 10	<input type="checkbox"/>	<input type="checkbox"/>	<input type="checkbox"/>	<input type="checkbox"/>	<input type="checkbox"/>	<input type="checkbox"/>	<input type="checkbox"/>	<input type="checkbox"/>	<input type="checkbox"/>	<input checked="" type="checkbox"/>
Account15	HS 10	<input type="checkbox"/>	<input type="checkbox"/>	<input type="checkbox"/>	<input type="checkbox"/>	<input type="checkbox"/>	<input type="checkbox"/>	<input type="checkbox"/>	<input type="checkbox"/>	<input type="checkbox"/>	<input checked="" type="checkbox"/>
Account16	HS 10	<input type="checkbox"/>	<input type="checkbox"/>	<input type="checkbox"/>	<input type="checkbox"/>	<input type="checkbox"/>	<input type="checkbox"/>	<input type="checkbox"/>	<input type="checkbox"/>	<input type="checkbox"/>	<input checked="" type="checkbox"/>
Account17	HS 10	<input type="checkbox"/>	<input type="checkbox"/>	<input type="checkbox"/>	<input type="checkbox"/>	<input type="checkbox"/>	<input type="checkbox"/>	<input type="checkbox"/>	<input type="checkbox"/>	<input type="checkbox"/>	<input checked="" type="checkbox"/>
Account18	HS 10	<input type="checkbox"/>	<input type="checkbox"/>	<input type="checkbox"/>	<input type="checkbox"/>	<input type="checkbox"/>	<input type="checkbox"/>	<input type="checkbox"/>	<input type="checkbox"/>	<input type="checkbox"/>	<input checked="" type="checkbox"/>
Account19	HS 10	<input type="checkbox"/>	<input type="checkbox"/>	<input type="checkbox"/>	<input type="checkbox"/>	<input type="checkbox"/>	<input type="checkbox"/>	<input type="checkbox"/>	<input type="checkbox"/>	<input type="checkbox"/>	<input checked="" type="checkbox"/>
Account110	HS 10	<input type="checkbox"/>	<input type="checkbox"/>	<input type="checkbox"/>	<input type="checkbox"/>	<input type="checkbox"/>	<input type="checkbox"/>	<input type="checkbox"/>	<input type="checkbox"/>	<input type="checkbox"/>	<input checked="" type="checkbox"/>
Account111	HS 10	<input type="checkbox"/>	<input type="checkbox"/>	<input type="checkbox"/>	<input type="checkbox"/>	<input type="checkbox"/>	<input type="checkbox"/>	<input type="checkbox"/>	<input type="checkbox"/>	<input type="checkbox"/>	<input checked="" type="checkbox"/>

Hunting Group configuration

Note

- o When the hunting group (Ringing Mode) is set to a HS, the handset can receive simultaneous calls in ringing state.
- o In parallel ringing mode, the missed call indicator is automatically cleared on all handsets once any device in the group checks the call history.

Configuration via Keypad

To configure the LCD menu using DP720/DP722/DP725/DP730/DP735's keypad, follow the instructions below:

- o Register the DP720/DP722/DP725/DP730/DP735 to DP755. Please see [Register DP Handsets to DP755 Base Station](#);
- o **Enter/Confirm/ selection:** Press the left softkey, right softkey, on-hook key or OK/Select key to enter the selected option, back to the last layer, or exit;
- o Exit: Press "right softkey" to exit to the previous menu;
- o Return to the Home page: Press the "On-hook" key to exit the main menu.

- The DP720/DP722/DP725/DP730/DP735 automatically exits to main mode with an incoming call, when the phone is off the hook or left idle for more than 20 seconds.
- When the phone is idle, pressing the DOWN navigation key can enter the **Outgoing call log**.

Please refer to [DP Handsets Menu Structure](#) for more details.

Call Features

The DP720/DP722/DP725/DP730/DP735 supports traditional and advanced telephony features including caller ID, caller ID with caller Name, call forward and etc.

*30	Block Caller ID (for all subsequent calls) Off hook the phone; Dial *30.
*31	Send Caller ID (for all subsequent calls) Off hook the phone; Dial *31.
*67	Call with Caller ID Blocked (per call) Off hook the phone; Dial *67 and then enter the number to dial out.
*82	Call with Caller ID Enabled (per call) Off hook the phone; Dial *82 and then enter the number to dial out.
*72	Unconditional Call Forward. To set up unconditional call forward: Off hook the phone; Dial *72 and then enter the number to forward the call; Press the OK softkey or SEND key.
*73	Cancel Unconditional Call Forward. To cancel the unconditional call forward: Off hook the phone; Dial *73;
*90	Busy Call Forward. To set up a busy call forward: Off hook the phone; Dial *90 and then enter the number to forward the call; Press the OK softkey or SEND key.
*91	Cancel Busy Call Forward. To cancel the busy call forward: Off hook the phone; Dial *91;
*92	Delayed Call Forward. To set up a delayed call forward: Off hook the phone; Dial *92 and then enter the number to forward the call; Press the OK softkey or SEND key.
*93	Cancel Delayed Call Forward. To cancel the delayed call forward: Off hook the phone; Dial *93;

DP755 Phonebook Management

DP720/DP722/DP725/DP730/DP735 support Private and Global Phonebooks; both phonebook types can be used at same time:

Private Phonebook

A private phonebook allows you to manage your contacts on each registered handset; each handset can have his own private phonebook with his own contacts. DP755 supports up to 10 private phonebooks.

A private phonebook can be assigned to one or more handsets registered to the base.

The following steps explain how to upload your private phonebook and assign it to a specific Handsets:

1. Access the Web GUI of your DP755 using the admin's username and password.
2. Press **Login** to access your settings and go to **Phonebook → Private Phonebook Settings**.

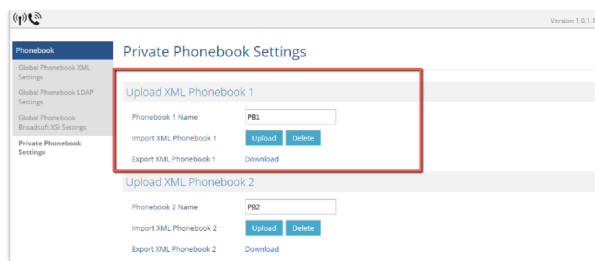

Private Phonebook Settings

3. In the **Private XML Phonebook X** section (X from 1 to 10):
 1. Enter Phonebook X Name (default value is PB1 for first Handset, PB2 for second Handset, etc.).
 2. Press the Upload button to Import XML Phonebook X.
 3. Browse your computer files and select your desired phonebook.xml file.
 4. Press Save and Apply to save your settings.
4. Go to the DECT → General Settings tab.
5. In the **Handsets Settings** section, select your **Handsets Phonebook** to assign it to a specific Handsets as shown below where **PB1** is assigned to **HS1**, **PB2** is assigned to **HS2**...

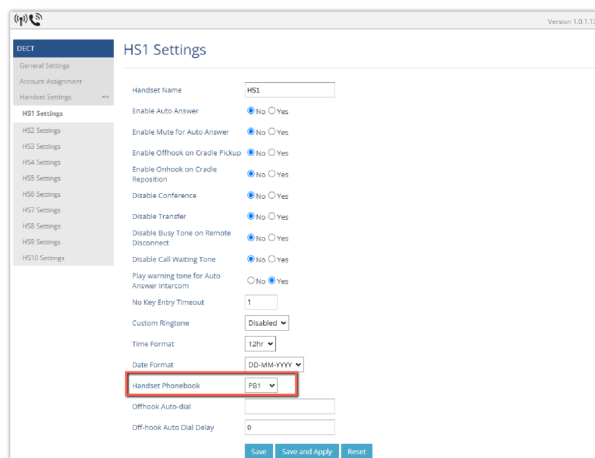

You can assign the same Private Phonebook to more than one Handsets.

For example, we can assign **Handsets Phonebook** named **PB1** to **HS1** and **HS2**.

Any change in **PB1** contacts will be applied to both **HS1** and **HS2** private phonebooks.

6. Press **Save and Apply** to save your configuration.

After applying your configuration, your DP720/DP722/DP725/DP730/DP735 Handsets will display uploaded phonebook contacts. You can access your private phonebook by pressing **Contacts** on your DP Handset. You can press Option Softkey in order to view, Create New Contact or Edit Dial if adding changes on a contact number is required before dialing.

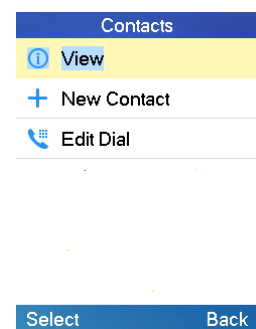
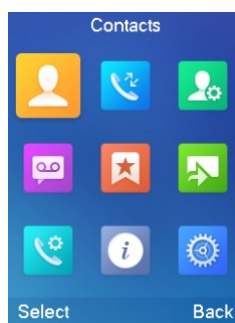

Global Phonebook

Global phonebook allows you to manage contacts and use them in all registered Handsets. The contacts can be imported either via XML or via LDAP. Follow the steps below to upload your shared phonebook:

Global Phonebook via XML

1. Access the Web GUI of your DP755 using the admin's username and password.
2. Press **Login** to access your settings.
3. Go to **Phonebook** → **Global Phonebook XML Settings** tab.
4. Set **Global Phonebook Type** to **XML** (in this case, LDAP phonebook will not be available).

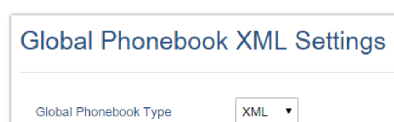

5. There are two methods to import/download your XML Phonebook:

o **Automatic XML Phonebook Download**

For this method, you need to use a TFTP or HTTP, or HTTPS server and make your phonebook.xml file available on your preferred server.

1. Set **Enable Automatic XML Phonebook Download** to **Enabled**, use **TFTP/HTTP or HTTPS** depending on your server.
2. If using HTTP or HTTPS server and User Name and Password are required to connect to the server, set **HTTP/HTTPS User Name** and **HTTP/HTTPS Password** fields with appropriate values.
3. Configure **Phonebook XML Server Path** field. This field could be an IP address or URL, with up to 256 characters. The phone will request a file named phonebook.xml from the provided directory. Example: server_URL/directory
4. Configure the Phonebook Download Interval (in minutes) to periodically contact your server to download a new phonebook file version if available. If set to 0, automatic download will be disabled. The valid range is 5 to 720.

Automatic XML Phonebook Download

o **Manual XML Phonebook Management**

1. Press **Upload** in **Import XML Phonebook**.
2. Browse your files and select your **phonebook.xml** file.

Manual XML Phonebook Management

XML Phonebook file format

```
<?xml version="1.0" encoding="UTF-8"?>
<AddressBook>
  <Contact>
    <FirstName>First name</FirstName>
    <LastName>Last name</LastName>
    <Ringtone>Ringtone ID (default 0)</Ringtone>
    <Phone type="Home">
      <phoneNumber>Home phone number</phoneNumber>
    </Phone>
    <Phone type="Work">
      <phoneNumber>Work phone number</phoneNumber>
    </Phone>
    <Phone type="Mobile">
      <phoneNumber>Mobile phone number</phoneNumber>
    </Phone>
  </Contact>
</AddressBook>
```

Object	Position	Type	Values	Comments
AddressBook	Root element	Mandatory	-	Root element of the XML document
Contact	Child element	Mandatory	-	Each contact is an entry
LastName	Child element	At least one of them present	String	Last name of the contact
FirstName	Child element	String	First name of the contact	
Phone	Child element	Mandatory	-	Phone number
PhoneNumber	Child element	At least one present	Int	Type="Home" or Type="Work" or Type="Mobile"

XML Phonebook Example:

```
<?xml version="1.0" encoding="UTF-8"?>
<AddressBook>
  <Contact>
    <FirstName>John</FirstName>
    <LastName>Doe</LastName>
    <Ringtone>0</Ringtone>
    <Phone type="Home">
      <phonenumber>1000</phonenumber>
    </Phone>
    <Phone type="Work">
      <phonenumber>1001</phonenumber>
    </Phone>
    <Phone type="Mobile">
      <phonenumber>1002</phonenumber>
    </Phone>
  </Contact>
  <Contact>
    <FirstName>Alice</FirstName>
    <LastName>Beck</LastName>
    <Ringtone>0</Ringtone>
    <Phone type="Home">
      <phonenumber>2000</phonenumber>
    </Phone>
    <Phone type="Work">
      <phonenumber>2001</phonenumber>
    </Phone>
    <Phone type="Mobile">
      <phonenumber>2002</phonenumber>
    </Phone>
  </Contact>
</AddressBook>
```

Global Phonebook via LDAP

1. Access the Web GUI of your DP755 using the admin's username and password.
2. Press **Login** to access your settings.
3. Go to **Phonebook** → **Global Phonebook LDAP Settings** tab.
4. Set **Global Phonebook Type** to **LDAP** (in this case, XML phonebook will not be available).

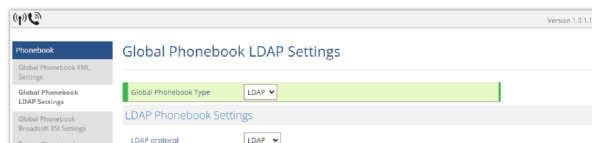

Global Phonebook LDAP Settings

5. Under **LDAP Phonebook Settings**, set your LDAP parameters to connect to your LDAP server. Refer to [Phonebook Page Definitions] for parameters explanation.
6. Press **Save and Apply** to save your configuration.

◦ Example of configuration:

```
LDAP protocol: LDAP
Server Address: 192.168.1.100
Port: 389
Base: dc=pbx,dc=com
User Name:
Password:
LDAP Filter: (mobile=*)(sn=*)
LDAP Version: Version 3
First Name Attribute: sn
Last Name Attribute: cn
Work Name Attribute:
Home Name Attribute:
Mobile Number Attribute: mobile
Max. Hits: 500
Search Timeout: 30
```

After applying your configuration, your global phonebook will be synchronized with all registered Handsets and contacts will be displayed on your DP720/DP722/DP725/DP730/DP735 Handsets screens.

DP755 ASSOCIATION WITH DP760 DECT REPEATER

Important Note

- DP760 can relay up to 2 concurrent calls.
- After pressing the Page/Reset button for more than 2 seconds on the DP760, it will enter AUTO region mode, in this mode, the three LEDs on right side keep quickly blinking, then the DP760 will search the base signal in the current environment to auto associate with it and then auto switch to the same region (EU, US or BR) of the base station.
- If you have a DP760 that has FW before 1.0.3.34, you will need upgrade it to 1.0.3.34 first, then do a factory reset. After that, the unit will support the Auto-Region feature and it will enter Auto-Region mode.
- DP755 does NOT include the DP760 model firmware, it can only work as an extended range for the DP755 but is not part of the base station's firmware releases.

Enabling Repeater Mode on DP755

Before associating the DP760 DECT Repeater to your DP755 Base Station, you should first enable the repeater mode on your base station. Please refer following steps to enable the repeater mode on the DP755 base station:

1. Access the Web GUI of your DP755 using the admin's username and password.
2. Navigate to **DECT** → **General Settings** and set **Enable Repeater Mode** to **Yes**.

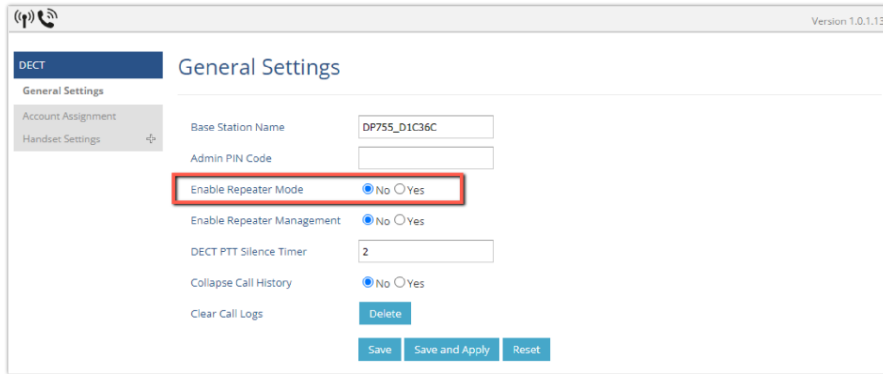

The screenshot shows the 'General Settings' page for the DECT system. The 'Enable Repeater Mode' option is selected as 'Yes'. Other settings include Base Station Name (DP755_D1C36C), Admin PIN Code, Enable Repeater Management (No), DECT PTT Silence Timer (2), Collapse Call History (No), and a Clear Call Logs button. At the bottom, there are Save, Save and Apply, and Reset buttons.

Enable Repeater Mode

3. Press **Save and Apply**, then **Reboot** the base to apply the new settings.

DP760 DECT Repeater Association

After enabling the repeater mode on DP755 Base Station, you can easily associate it with your DP760 DECT Repeater using one of the following methods:



- **Auto Association**
- **Manual Association**
- **Use DP755 Repeater Management to associate DP760**

Auto Association

To auto-associate your DP760 DECT Repeater with DP755 Base Station:

1. Power on the DP760 DECT Repeater.
2. After the DP760 finishes booting, the association LED will be blinking to indicate that the repeater is searching for nearby base stations.

Note: If all the LEDs remain on, it indicates that the DP760 Repeater has successfully associated with a DP755 Base and is ready for use. You may need to dissociate it before continuing (Please refer to [DP760 DECT REPEATER DISSOCIATION]).

3. Open a subscription on your DP755 Base Station using one of the following methods:
 1. Rebooting the Base station.
 2. Long press on page/subscribe  button on DP755 for 4 seconds.
 3. Access DP755 Web GUI and press subscribe button .
 4. Open the subscription through GDMS.
4. The DP760 DECT Repeater will automatically pair with DP755. Upon successful association with the DP755 Base station all LEDs will turn ON and the repeater status will be updated as following.



The screenshot shows the 'DECT Repeater Status' page. It displays the following information:

Repeater Name	DP760_9e274c
Repeater FW Version	FW 03.00 Build 1294
Repeater DECT RF Region	EU
Repeater Status	
Status	Repeater is in normal operation
Signal Strength	Link is excellent
Number of Active Calls	0
Global Functions	
Base Station RFPI Address	02C344DDA0 (RPN 2)
Base Station IP Address	192.168.5.141
Disconnect from Base Station	Disconnect

Repeater Status – Associated (Auto Association)

Notes



- For auto association, the option **Use manually configured RFPI** under DP760 Web GUI should be disabled (by default disabled).
- The RF auto association requires the repeater to be close to the base during the pairing process to work properly (this is a standard DECT repeater pairing limitation).

Manual Association

To manually associate your DP760 DECT Repeater to your DP755 Base Station:

1. Access the Web GUI of your DP760 using the admin's username and password.
2. Navigate to **DECT → General Settings** and set **Use Manually Configured RFPI** to **Yes**.
3. On **the** Manually Configured Base RFPI field, configure your DP755 Base Station RFPI address.

Note: The RFPI Address of your DP755 Base Station is available under the **Web GUI → Status → DECT Status → Base DECT RFPI Address**.

4. Click Save and Apply to confirm the new settings.
5. Open a subscription on your DP755 Base Station using one of following methods:
 - Rebooting the Base station
 - Long press on page/subscribe  button of DP755 for 7 seconds
 - Access DP755 Web GUI and press subscribe button  .
 - Open the subscription through GDMS.
6. The DP760 DECT Repeater will automatically pair with DP755. If the association is correctly associated, all the LEDs will remain solid on and the repeater status will be updated as following.



DECT Repeater Status	
Repeater Name	DP760_9e274c
Repeater FW Version	FW 03.00 Build 1294
Repeater DECT RF Region	EU
Repeater Status	
Status	Repeater is in normal operation
Signal Strength	Link is excellent
Number of Active Calls	0
Global Functions	
Base Station RFPI Address	02C344DDA0 (RPN 2)
Base Station IP Address	192.168.5.141
Disconnect from Base Station	Disconnect

Repeater Status – Associated (Manual Association)

Note

Make sure that **Repeater Mode** is enabled on your DP755 Base Station.

Use DP755 Repeater Management to Associate DP760

- **Enabling Repeater Management Mode**

The following steps illustrate how to enable and use the Repeater Management mode on DP755:

1. Access the Web GUI of your DP755 using the admin's username and password.
2. Navigate to **DECT → General Settings** and set **Enable Repeater Management** to **Yes**.
3. Press **Save and Apply**, then reboot the unit to apply the new settings.

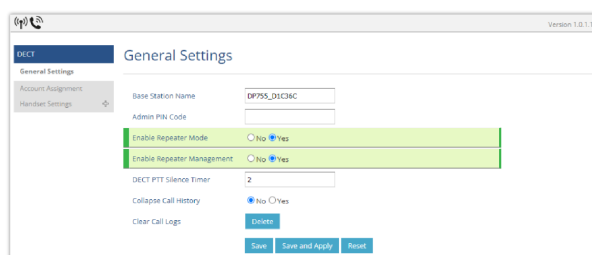

DECT General Settings	
Base Station Name	DP755_D1C38C
Admin PIN Code	
Enable Repeater Mode	<input checked="" type="radio"/> No <input checked="" type="radio"/> Yes
Enable Repeater Management	<input checked="" type="radio"/> No <input checked="" type="radio"/> Yes
DECT PTT Silence Timer	2
Collapse Call History	<input checked="" type="radio"/> No <input type="radio"/> Yes
Clear Call Logs	Clear
Save Save and Apply Reset	

Repeater Associated Status

- **Associating DP760 using Repeater Management Mode on DP755**

The repeater management mode displays discovered and paired devices using their name, IP and Mac addresses and also gives the possibility of associating the DP755 Base Station with DP760 DECT Repeater.

Please refer to following steps in order to associate DP760 with DP755 using repeater management mode:

1. Access the Web GUI of your DP755 using the admin's username and password.
2. Navigate to **Status → DECT Repeater Status** and select the repeater station from **Discovered Devices**.
3. Click the **Link** button to associate the base and repeater stations.

Note: The DP760 Repeater stations associated with DP755 Base Station are displayed and available under **Status → DECT Repeater Status → Paired Devices** with their status, signal strength, number of active calls, and the possibility to disconnect them from the paired base station.

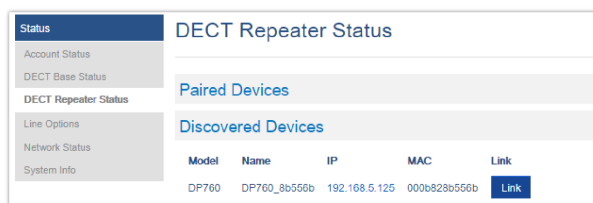

DECT Repeater Status on DP755

DP760 DECT REPEATER DISSOCIATION FROM DP755

To disconnect DP760 DECT Repeater from the Base Station DP755, please refer to the following options:

Using DP760 Web GUI

To disconnect your DP760 DECT Repeater via Web GUI, please refer to the following steps:

1. Access the Web GUI of your DP760 using the admin's username and password.
2. Enter the administrator's username and password to access the Web Configuration Menu.
3. Navigate to **Status → DECT Status → Global Functions** and press **Disconnect**.
4. The DP760 DECT Repeater will be automatically disconnected from the DP755 and it will start again scanning for available RFPs.

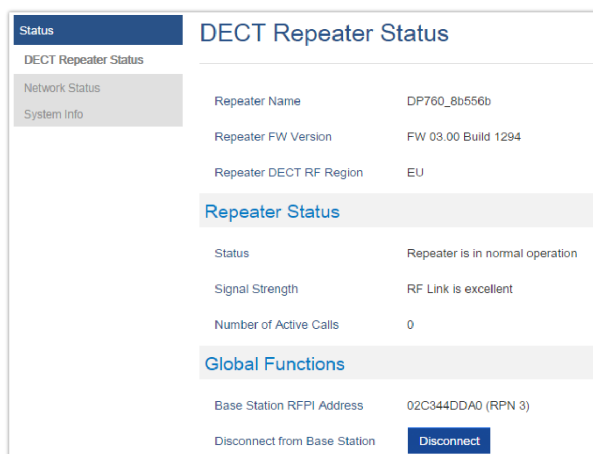

DECT Repeater Status on DP755

Using Page Button

A long press on the page button on the back panel of DP760 for 7 seconds, will remove the association values of the previous base station.

Using Repeater Management Mode on DP755

To disconnect your DP760 DECT Repeater using the repeater management mode on DP755:

1. Access the Web GUI of your DP755 using the admin's username and password.
2. Navigate to **Status → DECT Repeater Status**.
3. Select the repeater station from **Discovered Devices**.
4. Click the **Unlink** button to dissociate the repeater from the base station.

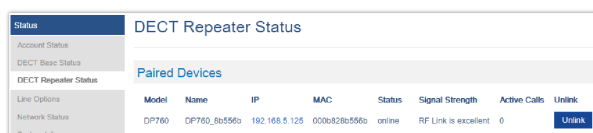

DECT Repeater Status on DP755

UPGRADING AND PROVISIONING

The DP755 can be upgraded via FTP/FTPS/HTTP/HTTPS by configuring the URL/IP Address for the FTP/FTPS/HTTP/HTTPS server and selecting a download method. Configure a valid URL for FTP/FTPS or HTTP/HTTPS; the server name can be FQDN or IP address.

Examples of valid URLs:

firmware.grandstream.com

fw.ipvideotalk.com/gs

DP755 Firmware Upgrade Procedure

Please follow the below steps in order to upgrade the firmware version of your DP755 base station:

- o Access DP755 Web GUI.
- o Press **Login** to access your settings.
- o Go to **Maintenance** → **Upgrade and Provisioning** page then either:
 1. Click start and upload the firmware file.

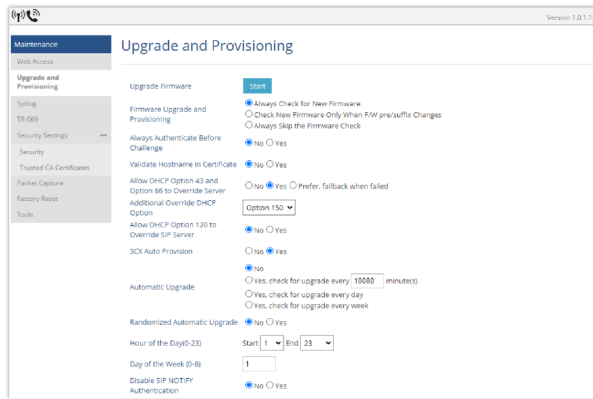

Firmware Upgrade

2. Enter the IP address or the FQDN for the upgrade server in the "Firmware Server Path" field and choose to upgrade via FTP/FTPS or HTTP/HTTPS.



Firmware Upgrade via Server

- o Make sure to configure Firmware **Upgrade and Provisioning to Always Check for New Firmware.**
- o Update the change by clicking the **"Save and Apply"** button. Then **"Reboot"** or power cycle the base station to update the new firmware.

Upgrading via Local FTP/HTTP Servers

For users that would like to use remote upgrading without a local FTP/HTTP server, Grandstream offers a NAT-friendly HTTP server. This enables users to download the latest software upgrades for their devices via this server. Please refer to the webpage: <http://www.grandstream.com/support/firmware>

Alternatively, users can download a free FTP or HTTP server and conduct a local firmware upgrade. A free Windows version FTP server is available for download from:

<https://filezilla-project.org/download.php?type=server>

Instructions for local firmware upgrade via FTP:

1. Unzip the firmware files and put all of them in the root directory of the FTP server.
2. Connect the PC running the FTP server and the phone to the same LAN segment.
3. Start the FTP server and configure the FTP server in the phone's web configuration interface.
4. Configure the Firmware Server Path to the IP address of the PC.
5. Configure the Admin and password authentication Credentials set on your FTP server.
6. Save and apply the changes and reboot the base station.

End users can also choose to download a free HTTP server from <http://httpd.apache.org/> or use a Microsoft IIS web server.

Upgrading DP720/DP722/DP725/DP730/DP735 Handsets

Users can upgrade their Handsets either using the LCD menu or via the Web GUI

Using the LCD menu

1. On DP720/DP722/DP725/DP730/DP735, press "Menu" (left softkey or the selection key) to bring up operation menu.
2. Press arrow keys to move the cursor to **Settings** and then press "Select".
3. Navigate to **Firmware Upgrade** and press "Select" (left softkey), the handset will upgrade the firmware available on the base station.

Using the Web GUI

1. Access DP755 Web GUI.
2. Press **Login** to access your settings.
3. Go to **the Maintenance → Firmware Upgrade** page, and enable the **Automatic Upgrade** option so the Handsets will upgrade the firmware automatically once it detects the new firmware.

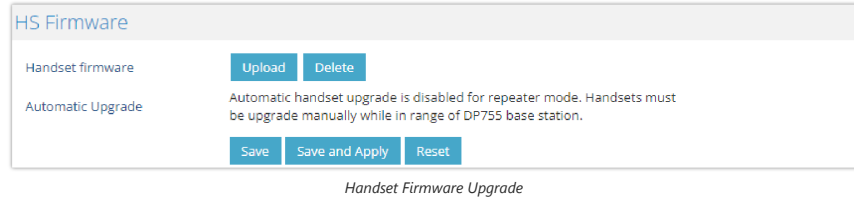

4. Update the change by clicking the "Save and Apply" button.

Notes

- o The DP720/DP722/DP725/DP730/DP735 Handsets detect automatically if the base station is upgraded with new firmware and display on the LCD a prompt message inviting the user to initiate the upgrade, moreover under the Web GUI of the base station **DP755 → Status → DECT base Status → Handsets Status**, appears an **Upgrade All** button once the base detects that several registered Handsets are using an old firmware version so the user could upgrade all Handsets by pressing **Upgrade All** button.
- o After downloading the firmware, DP720/DP722/DP725/DP730/DP735 screen will be black and a red LED will be blinking showing that firmware upgrade process is ongoing.

DP720/DP722/DP725/DP730/DP735 Provisioning

Configuration File Download

Grandstream SIP Devices can be configured via the Web Interface as well as via a Configuration File (binary or XML) through TFTP/FTP/FTPS or HTTP/HTTPS. The **Config Server Path** is the TFTP/FTP/FTPS or HTTP/HTTPS server path for the configuration file. It needs to be set to a valid URL, either in FQDN or IP address format. The **Config Server Path** can be the same or different from the **Firmware Server Path**.

A configuration parameter is associated with each particular field in the web configuration page. A parameter consists of a Capital letter P and 2 to 3 (Could be extended to 4 in the future) digit numeric numbers. i.e., P2 is associated with the "New Password" in the Web GUI→Maintenance→Web/SSH Access page→Admin Password. For a detailed parameter list, please refer to the corresponding firmware release configuration template.

The downloaded config file now will display the P value in new format, which has the more meaningful name of the parameter being configured. Below is an example of how new P values look like, please note that the old numeric P values will still be working, for example, in a single config file, the user can choose to use P values in the format of P9 or Pnetwork.static.address.ip.octet.1, or mixed-format for different settings, the device will take all of them. We are still improving the downloaded config file by adding the help text and re-ordering the settings to match the web.

```
7 <!--## Configuration Template ##-->
8 <!--#####-->
9 <!--#####-->
10 <!--## P values ##-->
11 <!--#####-->
12 <!--# Name: 8-->
13 <!--# Alias: network.type,NETWORK_TYPE # Help: IP Address Mode. 0 - DHCP, 1 - Static IP, 2 - PPPoE.-->
14 <!--# Attributes: Category=NUMBER Mandatory=1 Base=10 Range=[0-2] -->
15 <!--# Default Value: 0-->
16 <Pnetwork.type>0</Pnetwork.type>
17
18
19 <!--# Name: 9-->
20 <!--# Alias: network.static.address.ip.octet.1,NETWORK_STATIC_ADDRESS_OCTET1 # Help: IP Address octet 1. Ignore if DHCP or PPPoE is used.-->
21 <!--# Attributes: Category=NUMBER Mandatory=1 Base=10 Range=[0-255] -->
22 <!--# Default Value: 192-->
23 <Pnetwork.static.address.ip.octet.1>50</Pnetwork.static.address.ip.octet.1>
24
25
26 <!--# Name: 10-->
27 <!--# Alias: network.static.address.ip.octet.2,NETWORK_STATIC_ADDRESS_OCTET2 # Help: IP Address octet 2. Ignore if DHCP or PPPoE is used.-->
28 <!--# Attributes: Category=NUMBER Mandatory=1 Base=10 Range=[0-255] -->
29 <!--# Default Value: 168-->
30 <Pnetwork.static.address.ip.octet.2>84</Pnetwork.static.address.ip.octet.2>
31
32
33 <!--# Name: 11-->
34 <!--# Alias: network.static.address.ip.octet.3,NETWORK_STATIC_ADDRESS_OCTET3 # Help: IP Address octet 3. Ignore if DHCP or PPPoE is used.-->
35 <!--# Attributes: Category=NUMBER Mandatory=1 Base=10 Range=[0-255] -->
36 <!--# Default Value: 0-->
37 <Pnetwork.static.address.ip.octet.3>167</Pnetwork.static.address.ip.octet.3>
38
39
```

New P values format

When the DP755 boots up or reboots, it will send a request to download a file named "cfgxxxxxxxx" followed by a configuration XML file named "cfgxxxxxxxx.xml", where "xxxxxxxx" is the MAC address of the phone, i.e., "cfg00b820102ab" and "cfg00b820102ab.xml". If the download of "cfgxxxxxxxx.xml" file is not successful, the provision program will download a generic cfg.xml file. The configuration file name should be in lower case letters.

For more details on XML provisioning, please refer to:

<https://documentation.grandstream.com/knowledge-base/sip-device-provisioning-guide/>

Handsets Provisioning

To configure the Handsets provisioning, please browse the base station Web GUI at Maintenance → Provisioning. This is the same page used for base station provisioning. Handsets shares the settings of base station provisioning in the field in the red rectangle, and has its own settings in the blue rectangle. After enabling Handsets Config Upgrade, need to reboot the DP755 to take effect.

Provisioning Feature

- **Config Upgrade via:** Choose the method that the base station uses to request the Handsets ipei config file. Can use TFTP, FTP, FTSP, HTTP, or HTTPS.
- **Config Server Path:** Defines the server path for provisioning. Do not prepend the address with "http://" or any other protocol.
- **Handset Config File Prefix:** If configured, only the Handsets configuration file with the matching encrypted prefix will be downloaded and flashed into the device.
- **Handset Config File Postfix:** If configured, only the Handsets configuration file with the matching encrypted postfix will be downloaded and flashed into the device

When a DP720/DP722/DP725/DP730/DP735 registers to a DP755 for the first time or an already registered Handsets boots up, the DP755 will send a provisioning request for a file on the configured provisioning server, with location "Config_Server_Path/[Prefix][HS IPEI].xml[Postfix]". For example, if Handsets's IPEI number is 02c332b510, the prefix is "ipei_", postfix is null, and the config server path is "fw.grandstream.com/gs", the request URL is "fw.grandstream.com/gs/ipei_02c332b510.xml".

For more detailed information, please refer to [Handset Provisioning Guide](#).

Information Capture

Information Capture involves intercepting a secret key information file during the TLS handshake between the DP755 and a SIP server for the purpose of extracting the secret key information file during the TLS handshake, the file downloaded is a .txt file including the client secret key.

The process includes initiating capture, re-registering the DP755 with TLS to a SIP server, waiting for a SIP Register request, and then stopping the capture. The goal is to extract the secret key information file, to do that please follow the below steps described below:

- Start capturing the communication between the HT8xx and the server. to do that go to **Advanced settings** => **Information capture**, make sure "**With Secret Key information**" is set to Yes

- Re-register the DP755 account or port to the SIP server using the TLS protocol.

Network Settings

SIP Settings

Basic Settings

Custom SIP Headers

Advanced Features

Session Timer

Security Settings

Audio Settings

Call Settings

Intercom Settings

Feature Codes

Account 2

Account 3

Account 4

Account 5

Account 6

Account 7

Account 8

Account 9

Account 10

Account 11

TEL URI Disabled User=phone Enabled

SIP Registration No Yes

Unregister on Reboot No All Instance

Register Expiration

Subscribe Expiration

Reregister before Expiration

Enable OPTIONS Keep Alive No Yes

OPTIONS Keep Alive Interval

OPTIONS Keep Alive Max Lost

Enable TCP Keep Alive No Yes

Local SIP Port

SIP Registration Failure Retry Wait Time

SIP T1 Timeout

SIP T2 Timeout

SIP Transport UDP TCP TLS/TCP

SIP Listening Mode Transport Only Dual Dual (Secured)

- o Allow the system to wait until the DP755 sends a SIP Register request to the server.
- o Once the SIP Register request is sent, stop capturing the communication.

Maintenance

Web Access

Upgrade and Provisioning

Syslog

TR-069

Security Settings

Security

Trusted CA Certificates

Packet Capture

Factory Reset

Tools

Packet Capture

With RTP Packets

With Secret Key Information

Start Download Delete

Save Save and Apply Reset

Grandstream Networks Support | Open Source License

Copyright © Grandstream Networks, Inc. 2024. All Rights Reserved.

- o You have the possibility to now download the capture package that includes the TLS secret key.

Important

Please use Information capture only when authorized since extracting secret key information without proper authorization is considered unethical.

RESTORE FACTORY DEFAULT SETTINGS

Warning

Restoring the Factory Default Settings will delete all configuration information on the phone. Please backup or print all the settings before you restore to the factory default settings. Grandstream is not responsible for restoring lost parameters and cannot connect your device to your VoIP service provider.

Resetting the DP755 Base Station

Using Hardware Button

Long press the page button  on the device for approximately 30 seconds, until all LEDs blink rapidly several times and the device reboots.

Notes



- o The device will enter subscribe mode after about 8 seconds first, please keep pressing until factory reset.
- o Reset Type can be configured from **[Configure Hardware Button]**.

From Web Interface

1. Access DP755 Web GUI.
2. Navigate to **Maintenance** → **Factory Reset**.
3. Select the **Reset Type** from the reset drop-down list.
4. Press the **Reset** button and the unit will prompt a confirmation message, press **OK** to reset, then the unit restart automatically with parameters restored to default values or press **Cancel** to annul the reset.

Resetting the DP720/DP722/DP725/DP730/DP735 Handsets

Please follow the instructions below to reset the DP720/DP722/DP725/DP730/DP735 Handset:

1.   Press "Menu" (left softkey or the selection key) to bring up operation menu.
2. Press arrow keys to move the cursor to **Settings** and then press "Select".
3. Navigate to **System Settings → Factory Reset**, a warning window will pop out to make sure a reset is requested and confirmed;
4. Press **"Yes"** (left softkey) to confirm and the phone will reboot.

To cancel the Reset, press **"No"** (right softkey) instead.

Users also can perform factory reset using combo keys on DP720/DP722/DP725/DP730/DP735 during booting up prior it's fully booted, to give DP720/DP722/DP725/DP730/DP735 the ability to recover from some extreme cases like self-reboot or stuck right after booted up.

Please refer to following procedure for DP720/DP722/DP725/DP730/DP735 factory reset using combo key:

1. Connect the USB cable and power off DP720/DP722/DP725/DP730/DP735.
2. Power on DP720/DP722/DP725/DP730/DP735 and wait for Green LED.
3. Press 3 times Central Key (OK/Selection Key) quickly after Green LED on.
4. Press Speaker Key (left bottom) first and then Mute Key (right bottom) after Red LED on.
5. LED will start blinking in 3 colors: Green, Red and Orange if factory reset successful triggered.
6. Wait for about 1-3 minutes, the DP720/DP722/DP725/DP730/DP735 will boot up with setup wizard for initial language and date format settings.

CHANGE LOG

This section documents significant changes from previous firmware versions. Only major new features or major document updates are listed here. Minor updates for corrections or editing are not documented here.

Firmware Version 1.0.3.21

- No Major changes.

Firmware Version 1.0.3.19

- Added support the action URL for each handset separately. [[Action URL HSX](#)]
- Added automatic clearing missed call indicator on parallel ringing handsets. [[Hunting Groups](#)][[Call History](#)]
- Added remote access to device WebUI via GDMS. [[Remote Access to Web UI through GDMS](#)]
- Added "handset firmware downgrade not allowed" option. [[Automatic Upgrade](#)]
- Added "Circular" to ringing mode or hunting groups. [[Ringing Mode](#)][[Hunting Groups](#)][[DP755 Technical Specifications](#)]
- Added prompt for restart function. [[Saving the Configuration Changes](#)]
- Added "User-Agent Prefix". [[User-Agent Prefix](#)]
- Updated CPE to version 1.0.4.138. [[CPE](#)]

Firmware Version 1.0.3.16

- Added the ability to trigger subscription mode from GDMS. [[Open Subscription through GDMS](#)]
- Added the function "Sort Phonebook by: Last Name or First Name". [[Sort Phonebook by](#)]
- Added support for Phonebook Search Mode. [[Default Search Mode](#)]
- Updated CPE to version 1.0.4.116. [[CPE](#)]
- Added support for Broadsoft User Service Configuration features. [[Sort Phonebook by](#)][[Broadsoft Contacts Download Limitation](#)]

Firmware Version 1.0.3.14

- Added ability to delete BS call logs. [[Global Phonebook Broadsoft](#)]
- Added ability to sort BS call logs by name instead of just by date. [[Global Phonebook Broadsoft](#)]
- Added support for the option "Allow Unsolicited REFER". [[Allow Unsolicited REFER](#)]

Firmware Version 1.0.3.12

- Added Serial Number info on the webUI [[Serial Number](#)]
- Added automatic reboot option to the webUI. [[Automatic Reboot](#)]
- Synced P Values for XSI Account 1 to P Values for XSI on GRP/WP (IOT) [[Broadsoft XSI](#)]
- Added the option "Use SBC" [[Use SBC](#)]
- Added the option "G723 Rate" [[G723 Rate](#)]
- Added the option "Dial Plan Prefix" [[Dial Plan Prefix](#)]
- Added the option "Enable/Disable Weak Ciphers" [[Enable/Disable Weak Ciphers](#)]

Firmware Version 1.0.3.11

- Added support to dial a number in-call as DTMF upon pressing the transfer key. [[In-call Dial Number on Pressing Transfer Key](#)]
- Added the option to define the SIP User-Agent. [[SIP User-Agent](#)]
- Added the option "Return Code When Enable DND". [[Return Code When Enable DND](#)]
- Added support for Action URL. [[Action URL](#)]
- Added the option "Mute as DND" in Web UI. [[Enable Mute as DND](#)]
- Added the ability to handle simultaneous incoming calls to HS Hunting Group while handset is in ringing state. [[Hunting Groups](#)]
- Updated CPE to version 1.0.4.107. [[CPE](#)]

Firmware Version 1.0.3.8

- Disabled non-admin accounts by default. [[Enable User Web Access](#)]
- Added support to increase the TX volume in handset mode. [[Audio & Vibration](#)]

Firmware Version 1.0.3.7

- Changed "DNS SRV Failover" description. [[DNS SRV Failover mode](#)]
- Changed "Maximum Number of SIP Request Retries" default value to 2. [[Maximum Number of SIP Request Retries](#)]
- Added the management interface feature. [[Management Virtual IP Address Settings](#)]
- Added ability to allow "https://" in Config Server Path and Firmware Server Path. [[Config Server Path](#)] [[Firmware Server Path](#)]
- Added option to save syslog settings and internal logs after factory reset. [[Syslog Server](#)]

Firmware Version 1.0.3.4

- Added "Capture" options under Syslog. [[Syslog Capture](#)]
- Added "With Secret Key Information" under Packet Capture. [[With Secret Key Information](#)] [[Information Capture](#)]
- Added support for multiple XSI directories per SIP account. [[Broadsoft XSI](#)]
- Added support for XSI call log history. [[XSI call log history](#)]
- Added support for multicast PTT feature. [[PTT/Multicast](#)]

Firmware Version 1.0.1.16

- No Major changes.

Firmware Version 1.0.1.15

- DP755 supports 10 handset registrations and 16 simultaneous calls on 8 handsets. [[Handset registration](#)]
- DP755 does not include the DP760 model firmware, DP760 repeater firmware is included with the DP750/DP752 model firmware. [[DP760 Association](#)]

Firmware Version 1.0.1.13

- This is the initial version.
-